



THE UNIVERSITY *of* EDINBURGH

Edinburgh Research Explorer

## Integrating Distributed Generation Using Decentralised Voltage Regulation

**Citation for published version:**

Sansawatt, T, Ochoa, LF & Harrison, G 2010, Integrating Distributed Generation Using Decentralised Voltage Regulation. in *IEEE Power and Engineering Society General Meeting 2010*. Institute of Electrical and Electronics Engineers. <https://doi.org/10.1109/PES.2010.5588127>

**Digital Object Identifier (DOI):**

[10.1109/PES.2010.5588127](https://doi.org/10.1109/PES.2010.5588127)

**Link:**

[Link to publication record in Edinburgh Research Explorer](#)

**Document Version:**

Peer reviewed version

**Published In:**

IEEE Power and Engineering Society General Meeting 2010

**Publisher Rights Statement:**

(c) 2010 IEEE. Personal use of this material is permitted. Permission from IEEE must be obtained for all other users, including reprinting/ republishing this material for advertising or promotional purposes, creating new collective works for resale or redistribution to servers or lists, or reuse of any copyrighted components of this work in other works.

**General rights**

Copyright for the publications made accessible via the Edinburgh Research Explorer is retained by the author(s) and / or other copyright owners and it is a condition of accessing these publications that users recognise and abide by the legal requirements associated with these rights.

**Take down policy**

The University of Edinburgh has made every reasonable effort to ensure that Edinburgh Research Explorer content complies with UK legislation. If you believe that the public display of this file breaches copyright please contact [openaccess@ed.ac.uk](mailto:openaccess@ed.ac.uk) providing details, and we will remove access to the work immediately and investigate your claim.



# Integrating Distributed Generation Using Decentralised Voltage Regulation

Thipnatee Sansawatt, *Student Member, IEEE*, Luis F. Ochoa, *Member, IEEE*, and Gareth P. Harrison, *Member, IEEE*

**Abstract**—Voltage rise is a significant limitation when connecting large volumes of distributed generation (DG), particularly in rural distribution networks. One means of allowing further capacity penetration is to control voltage regulation devices such as on-load tap changers in a coordinated manner considering the variability of demand and generation. This approach, however, requires the deployment of communication systems, making it a potentially expensive option. To date, most DG technologies feature capabilities such as provision of reactive power or power factor control. Nonetheless, the ‘fit and forget’ approach for the connection of DG units to distribution networks neglects a more active, decentralised management where those and other capabilities could be used without the need of further infrastructure. This work proposes a decentralised control scheme where wind power-based DG units have a dual operation mode (power factor control and voltage control) in order to maintain the voltage at the connection bus within limits. Generators are also able to curtail their power output as a last resort to regulate the local voltage. Time-series analyses demonstrate the effectiveness of the decentralised methodology in adequately integrating DG capacity.

**Index Terms**—Distributed generation, distribution networks, decentralised voltage control, voltage regulation.

## I. INTRODUCTION

THE renewable generation industry has never before seen the volume of incentives and investments that governments worldwide are putting in place due to environmental and security of supply concerns. Large amounts of new generation capacity, particularly wind power, are expected to connect to transmission and distribution networks. The latter, however, are traditionally designed as passive circuits, and growing penetrations of distributed generation (DG) poses a number of technical challenges. Good wind resources are commonly found in rural areas, with lightly-loaded, long distribution feeders and voltage rise problems are therefore frequent and limit the generation capacity that can be connected [1].

Active network management, i.e., the use of real-time control and communication systems, certainly provides a

means to better integrate (renewable) distributed generators. Different centralised voltage control schemes have been proposed in the literature in order to allow more DG capacity to be connected [2-6]. Particular focus has been given to the real-time setting of the on-load tap changer of distribution substations. Indeed, by measuring or estimating the demand of the various feeders, coupled with measurements of the power injected by DG units, it is possible to determine an on-load tap changer (OLTC) setting that enables further power injections without exceeding voltage limits. In cases where curtailment schemes are in place, i.e., when DG units curtail their power injections due to voltage or thermal constraints, these measurements/estimations can also assist in calculating the amount of power that those generators must trim off to keep the network within its operational limits [7, 8].

Depending on the number of DG units to be accommodated, the required communication infrastructure might prove a centralised control approach economically unviable. Thus, decentralised schemes where distributed generators are able to contribute to voltage support by locally controlling their operation modes represent lower-cost alternatives as no further investments are required. Such a provision, however, will rely on the deployment of appropriate control mechanisms that not only consider the voltage at the connection points but also adapts to the variations produced by other voltage regulation devices (e.g., OLTCs). Additionally, while most DG technologies are capable of providing reactive power or power factor control, DG owners will only participate in these schemes if adequate economic incentives are made available.

Based on previous work [9-11], it is proposed that DG units, typically operated at a fixed power factor (e.g., unity), are capable of providing voltage support by operating as a PV bus (i.e., injecting or absorbing reactive power) when voltages exceed the limits. However, the effectiveness of this dual mode will inherently be restricted to the actual reactive power capabilities of the DG units. For this reason, generation curtailment is also considered, but as the last resort to regulate the local voltage.

This paper is structured as follows: Section II briefly explains the difference between centralised and decentralised voltage control. The proposed decentralised control mechanisms are presented in Section III. In Section IV, a simple 4-bus system provides a basic demonstration of the control approaches applied to a dispatchable DG interacting with an OLTC at the substation. A more substantial case study simulates an extended period follows (Section V), focusing on

---

This work is part-funded by the EPSRC SuperGen FlexNet Consortium – full details on <http://www.supergen-networks.org.uk/>. It is also part-funded through the EPSRC SuperGen V, UK Energy Infrastructure (AMPerES) grant in collaboration with UK electricity network operators working under Ofgem’s Innovation Funding Incentive scheme – full details on <http://www.supergen-amperes.org/>.

The authors are with the Institute for Energy Systems, School of Engineering, University of Edinburgh, Edinburgh, EH9 3JL, U.K. (e-mail: t.sansawatt@ed.ac.uk, luis\_ochoa@ieee.org, gareth.harrison@ed.ac.uk).

the performance of the control schemes in mitigating voltage rise issues with variable wind generation with particular regard to curtailed energy. Finally, the conclusions are drawn.

## II. CENTRALISED AND DECENTRALISED VOLTAGE CONTROL

For a long time, voltage regulation in a distribution network has been performed primarily by the OLTC transformer at the substation with its tap setting being adjusted to ensure voltage levels along the feeders are kept within statutory limits (e.g.,  $\pm 6\%$  of nominal). Reactive power compensation schemes such as switched shunt capacitors can also be used to improve voltage profiles, correct the power factor and reduce losses at transmission and distribution levels. With the presence of DG, nonetheless, these passive solutions seem to be less able to handle the variation of voltages caused by variable renewable generation.

Innovative control mechanisms implemented to regulate voltages can be classified into three different strategies: centralised, semi-coordinated and decentralised, as shown in Fig. 1. The former provides unidirectional voltage regulation where the OLTC transformer at the substation plays a key role in controlling the network voltage. The tap position is adjusted to control the voltage levels of the feeders beyond the transformer. The information used for the tap setting is obtained from, e.g., historical data of load and generation, seasonality and network configuration where a range of optimisation methods with wide area measurement and communication system are applied. At the other end of the spectrum, decentralised control uses local information to independently control voltage at a particular bus where measurement, optimisation and communication methods are usually limited. Semi-coordinated methods contribute to voltage control by combining the functions of both centralised and decentralised concepts. Because its control is based upon the coordination between devices, the communication system needs to be very reliable and robust. However, the degree of centralised or decentralised control has not yet been defined.

Each control concept has different features that may be compatible with a particular network but not with others. Judgment on network planning and policy will require a precise and comprehensive assessment of the schemes to be implemented.



Fig. 1. Voltage control strategies.

## III. DECENTRALISED CONTROL MECHANISMS

The dual mode and generation curtailment schemes are explained in detail in this section.

### A. Dual Mode – Power Factor and Voltage Control

Distribution Network Operators (DNOs) normally request DG units to either be capable of operating within a specific range of power factor (e.g., 0.95 inductive/capacitive) or to operate at a fixed power factor (e.g., unity). This requirement is based on the characteristics of the network and the penetration of DG, and aims to keep voltage profiles within limits and minimise interference with the voltage regulation provided by OLTCs or line drop compensators. From the DG owners' perspective, if an operating power factor range is given, the preference will be brought to unity power factor as no (economic) benefit will be gained from doing otherwise.

Considering the expansion of DG penetration as a primary policy, voltage rise will become a significant constraint for both the network operators and the DG owners in terms of securing the network reliability and maximising the power output, respectively. Implementing the proposed dual mode scheme can be an alternative option to satisfy both parties if there are adequate economic incentives in place.

The dual mode control approach is developed from the idea of combining the advantages of two operation modes of a generator: constant power factor control and voltage control [9-11]. For the former, the generator's power factor is set to a specific value (e.g., close to or at unity) according to the local requirements. In case the voltage at the connection point rises above the upper limit (e.g., 1.06pu), then the voltage control mode is used as a means of providing reactive power compensation to bring the voltage within the statutory limits. The functional methodology of the dual mode scheme is illustrated in Fig. 2.

Each operation mode will be activated according to the measured voltage at the connection point of the generator. During normal operation (the measured voltage is within the statutory upper and lower limits), the power factor control mode is adopted as default. At times when the measured voltage rises or drops beyond the limits, the generator will adopt the voltage control mode, serving as a PV bus for a certain period. After the voltage rise problem is overcome, the generator will return to the default operation mode, i.e., power factor control.

Although there will be times when the generator does not operate close to or at the specified power factor (as desired), this dual mode scheme will not require a significant amount of reactive power injection/absorption as it will depend on the generator's capabilities. Indeed, this is a trade-off between potentially reducing active power export over a relatively short period and enabling higher generation capacity and energy production in the long term.

### B. Generation Curtailment

Traditionally DG units are connected using a 'fit and forget' approach, i.e., there is no need of actively managing the network as under no circumstance will the connected generation capacity exceed voltage or thermal limits. While the previously presented dual control mode will allow more capacity to be accommodated, trimming off power generation

during worst case scenarios (e.g. minimum demand, maximum generation) will enable further penetration of DG [7],[12] [13]. This scheme is particularly cost-effective when these worst scenarios have a very low occurrence, as it is often the case of wind power.

The generation curtailment strategy adopted in this work is illustrated in Fig. 3. It is implemented to tackle the voltage rise problem but only acts as a last resort by operating if the dual mode was not successful. This scheme will reduce a given percentage of the power output when the voltage at the connection bus exceeds the statutory limit. If, after the curtailment, the voltage at the connection bus is kept within the limits, the operating conditions for the DG unit are kept until the next cycle of measurements, enforcing a time delay before allowing the DG to increase its output by one step back to the previous level. This will allow other devices to actuate and avoid the *hunting* effect that can arise from a continuous increase or decrease of the DG output during the short-time voltage rise. Should the voltage exceed the upper limit, the DG output is further curtailed on the next cycle. In general,

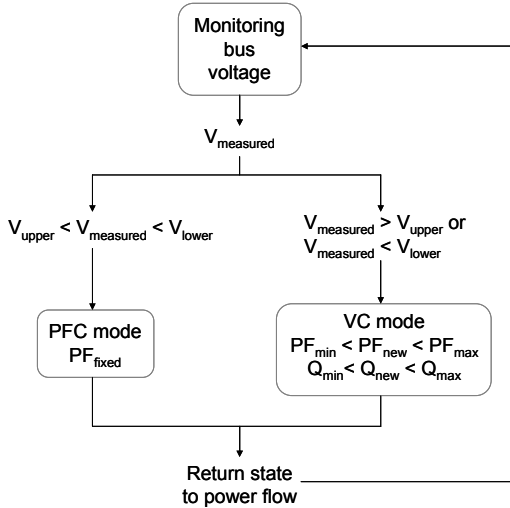

Fig. 2. Functional diagram of the dual mode (power factor and voltage control).

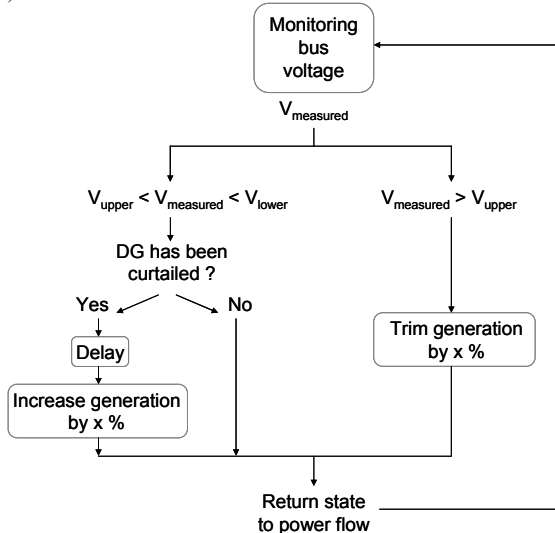

Fig. 3. The proposed generation curtailment (GC) strategy.

the amount of power to be constrained can be calculated based on various factors such as the voltage limits, sensitivity of the network, operational response and capacity of the DG unit and load characteristics [7, 8].

#### IV. SIMPLE DEMONSTRATION OF DUAL MODE AND GENERATION CURTAILMENT SCHEME

A relatively simple example is used here to illustrate the behaviour of the control schemes. A simple 4-bus test feeder is simulated using for a typical worst case voltage rise scenario of a generator operating at maximum output during minimum demand conditions. Over a 120-second simulation the capacity required to breach the test feeder voltage limits under the prevailing 'fit and forget' approach are evaluated. This capacity is then used to demonstrate the control actions in constraining voltage within limits. All simulations are performed using the PSS/E software interfaced with Python.

##### A. 4-bus Test Feeder

Fig. 4 shows the 4-bus 11kV test feeder with a peak demand of 1.22MW. A second by second profile is adopted. The 120-second test period shown in Fig. 5 was chosen to represent the minimum demand scenario. A firm DG unit (e.g., CHP plant) capable of providing a 0.95 inductive/capacitive power factor is considered in the analysis (adopting a unity power factor under normal operation). At the 20<sup>th</sup> second, a fast ramp of the CHP unit (from 0.65pu to 1pu) is included in order to investigate the response of the proposed voltage regulation mechanisms.

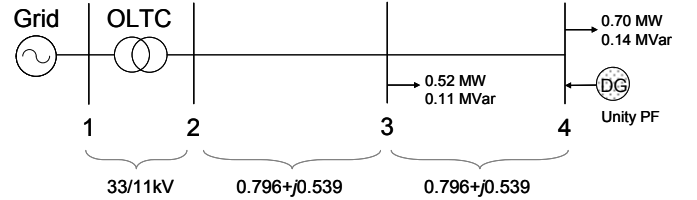

Fig. 4. 4-bus 11kV test feeder at maximum demand.

##### B. Results

To demonstrate the ability of the proposed schemes in freeing up more generation capacity, it is important to define the capacity restrictions that apply under the 'fit and forget' approach. For this purpose, the 120-second steady state analysis is initially applied to a 1MW DG unit with the capacity subsequently incremented by 1MW until a constraint violation occurs. As shown in Fig. 6 (top), a capacity of greater than 3MW will result in voltages above the upper limit (1.06pu); this represents the critical generation level and is used to benchmark the voltage regulation mechanisms.

Four operating modes: fixed power factor control, dual mode, generation curtailment, and the combination of the latter two are investigated. In all cases, the OLTC transformer is assumed to be operating with a time delay of 30 seconds being applied to any single step change in tapping up or down. This is to allow the decentralised control mechanisms at the DG unit (which are fast-reacting) to handle voltage rise as the primary regulation. The delay time is selected for simplicity in

demonstrating the proposed schemes' mechanisms and performance over the simulation period. The OLTC settings are assumed known the DG developers. Thus, the curtailment strategy is assumed to be adjusted at the 30<sup>th</sup> second time delay of the tap control. The generation curtailment rate is set to 10% of the instantaneous power output of the DG unit at each time step (measurement cycle). This value is regarded as a reasonable first assumption to illustrate the process but more precise values would be gained through detailed analysis of the sensitivity of voltage to changes in power injection. Given the decentralised nature of the approach, it there is no communication between the substation and the DG unit.

Fig. 6 (bottom) illustrates the bus 4 voltage profiles corresponding to the four operating modes and a 3MW DG. Significant voltage rise occurs at the 20<sup>th</sup> second due to the ramp of the DG (at fixed unity power factor). The 30 second delay on the OLTC senses the tap position to be adjusted at the 30<sup>th</sup> and 60<sup>th</sup> seconds in response to the resulting voltage rise. The control schemes at the DG connection point also respond to voltage rise but following their corresponding time responses. The dual mode and the combined mode with generation curtailment show better performance against severe voltage rise scenarios, largely by injecting/absorbing reactive power. Generation curtailment alone is able to limit voltage rise but requires the power output to be trimmed 4 times (with 10% each time) over the test period. For the combined mode, the curtailment strategy is not activated as voltage control in the dual mode alone is able to deal with the voltage problems in this case. In more severe circumstances where the reactive power capability limits the dual mode ability to maintain voltage, the curtailment strategy is applied in coordination (Section V).

The schemes demonstrate effective responses to voltage rise constraints on a simple feeder. However, distribution network complexity and the load and generation variability may make voltage rise a more critical issue with the control mechanisms more challenging to implement.

## V. CASE STUDY

This section examines the effectiveness of the control schemes in a more complex 30-bus rural distribution system populated with variable load and wind generation. The simulations are carried out over a longer 1-month time scale at a 5-minute interval. The performance of the control schemes are assessed on the basis of voltage rise mitigation, energy output, curtailed generation and voltage headroom.

### A. 30-bus Rural Distribution System

The system shown in Fig. 7 is a simplified version of the HVOHa 11kV radial distribution system available in [14]. The circuit originally consisted of two main feeders supplying 354 loads (356 buses in total) located in a rural area with long lines and low customer density: characteristics appropriate for voltage impact studies. The simplified system comprises 30 buses with 28 loads and a peak demand of 0.545MW. The

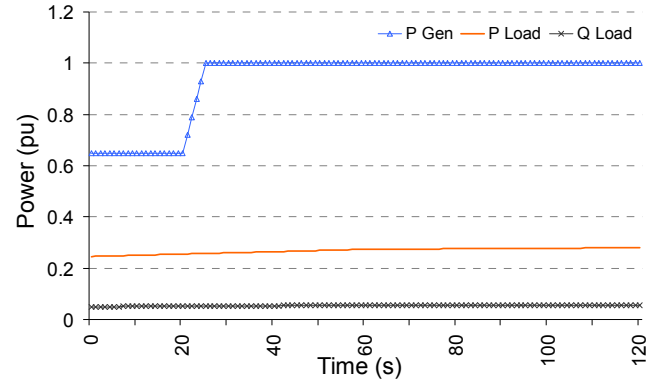

Fig. 5. 120-second time series for both generation and demand.

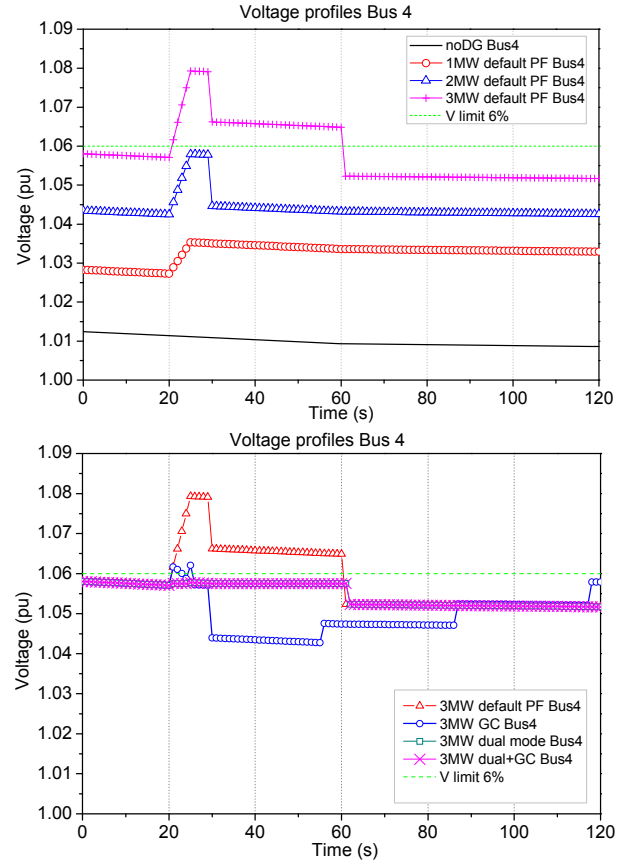

Fig. 6. (Top) Voltage profiles at bus 4 for the different DG nominal capacities, and (bottom) considering the different regulation cases with a 3MW DG unit. Note: GC refers to the generation curtailment scheme.

data is provided in Table I. Load and wind speed data for central Scotland in August 2003 was adopted [15]. Wind generation profiles were produced by applying a generic wind power curve to the wind speed data. August 2003 is the summer month with the minimum demand of this particular year. However, although wind speeds are naturally below average, sudden high peaks do appear. Consequently, this data provides a credible scenario for testing the performance of the voltage regulation mechanisms.

Two wind farms are connected to feeder 2. Wind farm 1 (WF1) and wind farm 2 (WF2) are installed at the remote nodes 1156 and 1184, respectively. In terms of penetration, a

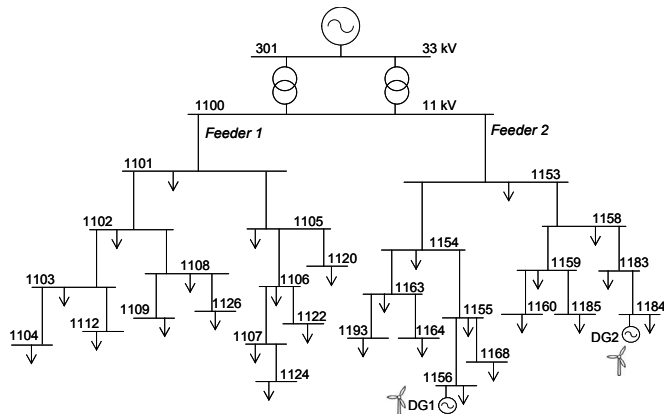

Fig. 7. 30-bus 11kV rural distribution system.

TABLE I  
NETWORK DATA - SIMPLIFIED 30-BUS 11kV DISTRIBUTION SYSTEM

From bus	To bus	Line R (pu)	Line X (pu)	Rating (MVA)	To bus P Load (MW)	To bus Q Load (MVar)
1100	1101	0.2508	0.1698	4.17	0.015	0.003
1101	1102	0.2508	0.1698	4.17	0.015	0.003
1102	1103	0.2508	0.1698	4.17	0.02	0.004
1103	1104	0.2508	0.1698	4.17	0.02	0.004
1101	1105	0.248	0.178	2.95	0.01	0.002
1105	1106	0.248	0.178	2.95	0.01	0.002
1106	1107	0.248	0.178	2.95	0.015	0.003
1102	1108	0.186	0.1335	2.95	0.015	0.003
1108	1109	0.186	0.1335	2.95	0.015	0.003
1103	1112	0.186	0.1335	2.95	0.015	0.003
1105	1120	0.3556	0.1331	2	0.035	0.007
1106	1122	0.3556	0.1331	2	0.035	0.007
1107	1124	0.3556	0.1331	2	0.035	0.007
1108	1126	0.3556	0.1331	2	0.035	0.007
1100	1153	0.3185	0.2156	4.17	0.015	0.003
1153	1154	0.3185	0.2156	4.17	0.015	0.003
1154	1155	0.3185	0.2156	4.17	0.015	0.003
1155	1156	0.3185	0.2156	4.17	0.015	0.003
1153	1158	0.1892	0.1358	2.95	0.005	0.001
1158	1159	0.1892	0.1358	2.95	0.005	0.001
1159	1160	0.1892	0.1358	2.95	0.01	0.002
1154	1163	0.1892	0.1358	2.95	0.01	0.002
1163	1164	0.1892	0.1358	2.95	0.01	0.002
1155	1168	0.1892	0.1358	2.95	0.01	0.002
1158	1183	0.396	0.1482	2	0.035	0.007
1183	1184	0.396	0.1482	2	0.035	0.007
1159	1185	0.396	0.1482	2	0.035	0.007
1163	1193	0.396	0.1482	2	0.04	0.008

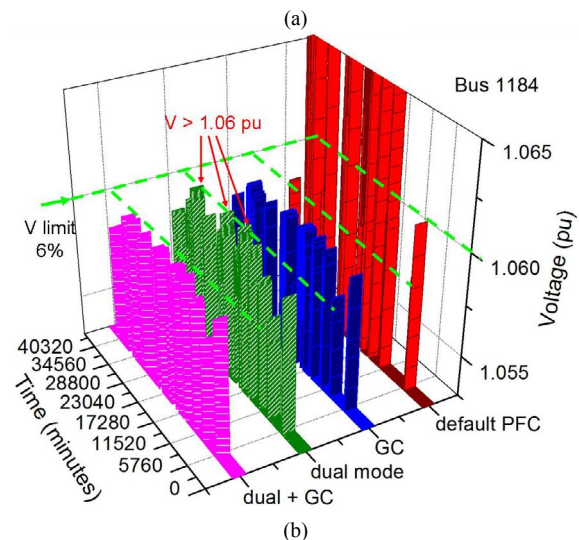
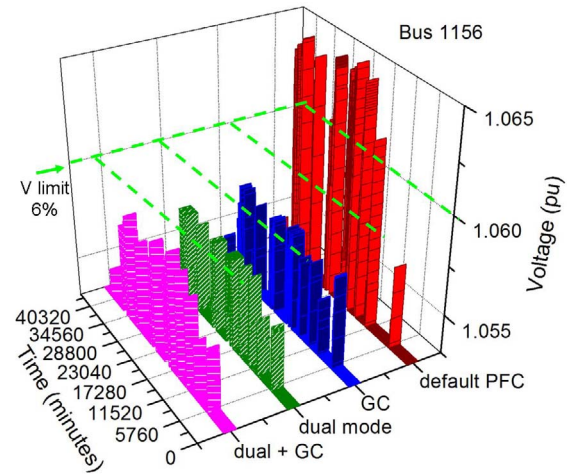

Fig. 8. Voltage profiles at buses 1156 (a) and 1184 (b), zoomed in at the upper voltage limit. Note: GC refers to the generation curtailment scheme.

‘fit and forget’ approach would see voltage rise problems with 3 and 4MW of nominal capacity for WF1 and WF2, respectively. Hence, those values will be considered to assess the effectiveness of the methodology. Feeder 1 is left without generation to take account of the difficulties (for the OLTC) of catering for passive and active feeders at the same time. Given the 5-minute time step, in this analysis all voltage regulation mechanisms adopt this new setting cycle. For the generation curtailment, the trimming rate of 10% of the instantaneous wind output for each measurement cycle is applied. Again, this is assumed to be a reasonable minimum reduction over this relatively short measurement period.

## B. Results

Four operating modes: fixed power factor control, dual mode, generation curtailment, and the combination of the latter two are investigated. Voltage profiles at the DG connected buses (1156 and 1184) are depicted in Fig. 8. Without voltage regulation, i.e., for unity power factor control only, voltages exceed the upper limit at both locations,

particularly near the middle of the month due to the high wind speeds. On the other hand, the other three operating modes show better results in handling the voltage problems. For bus 1156, voltage rise can be mitigated by the dual mode, generation curtailment, and the combination of them. However, the voltage rise experienced by bus 1184 is more severe and can only be completely mitigated by the combination of the dual mode and curtailment strategies. With the dual mode alone, there are some periods where it is not possible to cope with voltage rise as the generator approaches its reactive power limit (Fig. 8 (b)).

## C. Assessing the Overall Performance of the Schemes

The net energy production and the energy lost due to curtailment for the two wind farms are shown in Table II considering the different control schemes. For WF1 (bus 1156), the dual mode, generation curtailment and the combination of both are all able to cope with voltage rise. For WF2, however, only the generation curtailment and the combination scheme can mitigate the voltage rise problem, although at the expense of trimming its output. The dual mode alone leads to voltage rise as the reactive capability limit is reached.

Although the curtailment strategy can ensure system voltages do not exceed the upper limit in a manner as effective as the dual mode (provided reactive power is available), overall energy production is restricted. Hence, this scheme alone might hamper the economics of a generation developments. Consequently, as this analysis demonstrates, the combination of the dual mode and curtailment appears to be an effective strategy to mitigate voltage rise whilst minimising energy production losses.

TABLE II  
ENERGY OUTPUT, ENERGY CURTAILED, VOLTAGE RISE

	Bus 1156 (WF1)			Bus 1184 (WF2)		
	GC	dual	dual+GC	GC	dual	dual+GC
Energy output (GWh)	9.954	10.2	10.2	10.203	11.067	10.875
Energy curtailed (GWh)	0.244	0	0	0.864	0	0.192
Voltage rise mitigated	Yes	Yes	Yes	Yes	No	Yes

## VI. CONCLUSIONS

In rural distribution networks, voltage rise is a major constraint to accommodating distributed generation. Here, a decentralised voltage control mechanism has been presented wherein DG units alternate between power factor control and voltage control to mitigate voltage rise problems. Generation curtailment, a last resort if reactive power limitations arise, was also introduced. Results confirm that the schemes are able to cope with severe voltage rise. These mechanisms represent an alternative, low-cost solution that allows DNOs handle voltage issues and the DG developer connect greater generation capacity without network reinforcements. This work can be seen as an initial investigation of the effectiveness of decentralised control schemes in contributing to active voltage management to enable connection of DG capacity where communication opportunities are limited.

## VII. REFERENCES

- [1] C. L. Masters, "Voltage rise: the big issue when connecting embedded generation to long 11 kV overhead lines," *IEE Power Eng. J.*, vol. 16, no. 1, pp. 5-12, Feb. 2002.
- [2] F. Bignucolo, R. Caldon, and V. Prandoni, "Radial MV networks voltage regulation with distribution management system coordinated controller," *Electric Power Systems Research*, vol. 78, no. 4, pp. 634-645, 2008.
- [3] V. Thornley, J. Hill, P. Lang, and D. Reid, "Active network management of voltage leading to increased generation and improved network utilisation," in *Proc. 2008 SmartGrids for Distribution, 2008. IET-CIRED. CIRED Seminar*, pp. 1-4.
- [4] M. Fila, J. Hiscock, D. Reid, P. Lang, and G. A. Taylor, "Flexible voltage control in distribution networks with distributed generation - modelling analysis and field trial comparison," in *Proc. 2009 20th International Conference on Electricity Distribution, 2009. CIRED 2009*, vol. Session 4, pp. 1-4.
- [5] T. Xu, P. Taylor, M. Prodanovic, T. Green, E. Davidson, and S. McArthur, "Case based reasoning for distributed voltage control," in *Proc. 2009 20th International Conference on Electricity Distribution, 2009. CIRED 2009*, vol. Session 4, pp. 1-4.
- [6] L. F. Ochoa, C. Dent, and G. P. Harrison, "Distribution network capacity assessment: Variable DG and active networks," *IEEE Trans. on Power Systems*, In Press.
- [7] R. A. F. Currie, G. W. Ault, C. E. T. Foote, and J. R. McDonald, "Active power-flow management utilising operating margins for the increased

- connection of distributed generation," *IET Gener. Transm. Distrib.*, vol. 1, no. 1, 2007.
- [8] R. A. F. Currie, G. W. Ault, R. W. Fordyce, D. F. MacLeman, M. Smith, and J. R. McDonald, "Actively managing wind farm power output," *IEEE Trans. on Power Systems*, vol. 23, no. 3, pp. 1523-1524, Aug. 2008.
- [9] A. E. Kiprakis and A. R. Wallace, "Maximising energy capture from distributed generators in weak networks," *IEE Proc., Gen., Transm. & Distrib.*, vol. 151, no. 5, pp. 611-618, 2004.
- [10] T. Sansawatt, J. B. O'Donnell, L. F. Ochoa, and G. P. Harrison, "Decentralised Voltage Control for Active Distribution Networks," in *Proc. 2009 44th International Universities' Power Engineering Conference (UPEC 2009)*.
- [11] A. E. Kiprakis, "Increasing the Capacity of Distributed Generation in Electricity Networks by Intelligent Generator control," Doctor of Philosophy dissertation, University of Edinburgh, Edinburgh, 2005.
- [12] R. A. F. Currie, G. W. Ault, R. W. Fordyce, D. F. MacLeman, M. Smith, and J. R. McDonald, "Actively managing wind farm power output," *IEEE Transactions on Power Systems*, vol. 23, no. 3, pp. 1523-1524, 2008.
- [13] Q. Zhou and J. W. Bialek, "Generation curtailment to manage voltage constraints in distribution networks," *Generation, Transmission & Distribution, IET*, vol. 1, no. 3, pp. 492-498, 2007.
- [14] L. F. Ochoa and A. Padilha-Feltrin, "Distribution line models for loss calculation in three-phase three-wire power flow algorithms," in *Proc. 2004 IEEE/PES T&D Latin America*, pp. 1-6.
- [15] T. Boehme, J. Taylor, A. R. Wallace, and J. Bialek, "Matching Renewable Electricity Generation with Demand," *Scottish Executive*, Edinburgh, 2006.



**Thipnatee Sansawatt** (S'09) received the B.Eng. degree in 2006 from Sirindhorn International Institute of Technology (SIIT), Thammasat University, Bangkok, Thailand. She obtained the M.Sc. degree in 2007 from the School of Engineering, University of Edinburgh, U.K., where she is currently pursuing the Ph.D. degree. She is also a student member of the IET. Her research interests include distributed generation and active distribution networks.



**Luis F. Ochoa** (S'01-M'07) is a Research Fellow in the School of Engineering, University of Edinburgh, U.K. He obtained his BEng degree from UNI, Lima, Peru, in 2000, and the MSc and PhD degrees from UNESP, Ilha Solteira, Brazil, in 2003 and 2006, respectively.

His current research interests include network integration of distributed energy resources and distribution system analysis. Dr. Ochoa is also a member of the IET.



**Gareth P. Harrison** (M'02) is a Senior Lecturer in Energy Systems in the School of Engineering, University of Edinburgh, U.K.. His current research interests include network integration of distributed generation and analysis of the impact of climate change on the electricity industry.

Dr. Harrison is a Chartered Engineer and member of the Institution of Engineering and Technology, U.K.