



THE UNIVERSITY *of* EDINBURGH

Edinburgh Research Explorer

Bovine Tuberculosis in Cattle and Badgers

Citation for published version:

Krebs, J, Anderson, R, Clutton-Brock, T, Morrison, I, Young, D & Donnelley, C 1997, *Bovine Tuberculosis in Cattle and Badgers*. MAFF. <<http://www.bovinetb.info/docs/krebs.pdf>>

Link:

[Link to publication record in Edinburgh Research Explorer](#)

General rights

Copyright for the publications made accessible via the Edinburgh Research Explorer is retained by the author(s) and / or other copyright owners and it is a condition of accessing these publications that users recognise and abide by the legal requirements associated with these rights.

Take down policy

The University of Edinburgh has made every reasonable effort to ensure that Edinburgh Research Explorer content complies with UK legislation. If you believe that the public display of this file breaches copyright please contact openaccess@ed.ac.uk providing details, and we will remove access to the work immediately and investigate your claim.



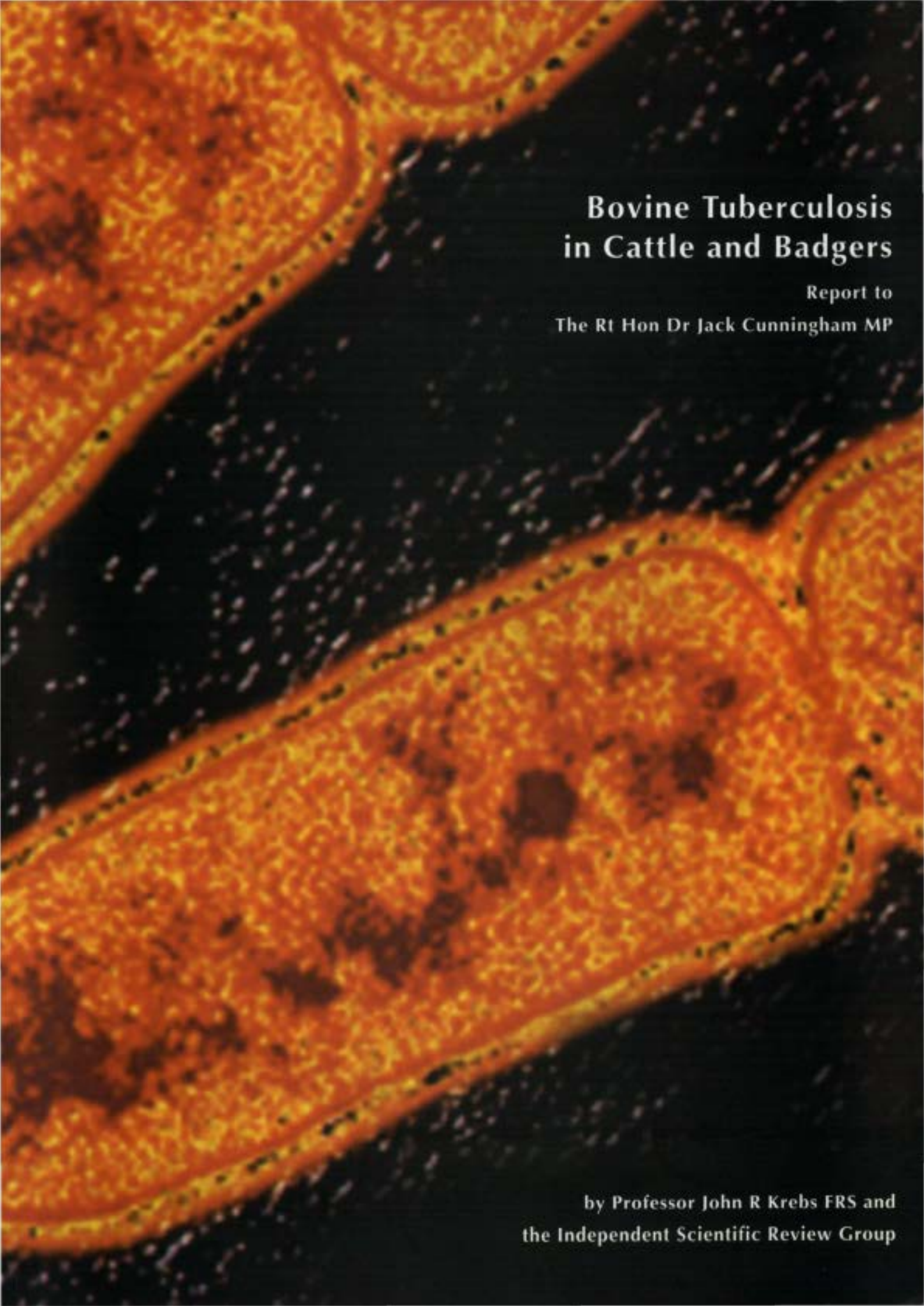

Bovine Tuberculosis in Cattle and Badgers

Report to
The Rt Hon Dr Jack Cunningham MP

by Professor John R Krebs FRS and
the Independent Scientific Review Group

BOVINE TUBERCULOSIS IN CATTLE AND BADGERS

Report by The Independent Scientific Review Group

Professor John Krebs FRS (Chairman)

Chief Executive of the Natural Environment Research Council

Professor Roy Anderson FRS

Director of the Wellcome Trust Centre for the Epidemiology of Infectious Disease and Linacre Professor and Head of the Department of Zoology at the University of Oxford

Professor Tim Clutton-Brock FRS

Professor of Animal Ecology at the University of Cambridge

Professor Ivan Morrison

Head of the Division of Immunology and Pathology at the Compton Laboratory of the Institute for Animal Health

Professor Douglas Young

Fleming Professor of Medical Microbiology at Imperial College School of Medicine

Dr Christl Donnelly

Research statistician at the Wellcome Trust Centre for the Epidemiology of Infectious Disease at the University of Oxford

The Group was assisted by:

Dr Simon Frost

Department of Zoology at the University of Oxford

Dr Rosie Woodroffe

Research Fellow at the Department of Zoology, University of Cambridge

	Page number
Executive Summary	6
Chapter 1 – Background	
1.1 Introduction	10
1.2 Bovine TB and human health	10
1.3 Bovine TB and animal health	13
1.4 Measures to tackle the TB threat from badgers	14
1.5 Legislative position	18
1.6 The international picture	20
1.7 MAFF research	20
1.8 MAFF objectives	21
1.9 Conclusions and recommendations	22
Figure 1.1 Proportion of total herds with reactors (both confirmed and unconfirmed) 1962 to 1996	13
Figure 1.2 MAFF TB research expenditure 1997/98	20
Figure 1.3 MAFF TB research expenditure 1997/98 by contractor	21
Chapter 2 – Evidence for the transmission of <i>Mycobacterium bovis</i> from badgers to cattle	
2.1 Introduction	24
2.2 Badgers and other potential wildlife reservoirs for <i>M. bovis</i>	24
2.3 Transmission of <i>M. bovis</i> from cattle to cattle and other species	27
2.4 Evidence of association between <i>M. bovis</i> in badgers and TB in cattle	28
2.5 Evidence of transmission of <i>M. bovis</i> from badgers to cattle	29
2.6 Conclusions and recommendations	32
Table 2.1 Wildlife examined and not detected to be infected with <i>M. bovis</i> 1971 to 1986	25
Table 2.2 Prevalence of <i>M. bovis</i> infection in infected wildlife	26
Table 2.3 The number of isolates and ‘spoligotypes’ taken from humans, cattle and wildlife 1988-1997	31
Chapter 3 – TB in badgers	
3.1 Introduction	34
3.2 Prevalence, distribution and history of badger TB in Europe	34
3.3 Badger demography, population structure and behaviour	35
3.4 TB within badger populations	44
3.5 What conditions are likely to facilitate TB transmission from badgers to cattle?	49
3.6 Effects of badger management strategies upon badger populations and behaviour	51
3.7 Conclusions	53

	Page number	
Table 3.1	Estimated main sett densities in Britain for 1988–1997, based upon repeated surveys of 1km ² squares, in studies commissioned by the Mammal Society and the People’s Trust for Endangered Species	37
Table 3.2	Studies of badgers carried out in the British Isles	38
Table 3.3	Summary of demographic variables in the four best-studied British badger populations	40
Table 3.4	Prevalence of <i>M. bovis</i> infection in badger individuals and social groups killed in the course of badger removal operations	46
Figure 3.1	The estimated density of badger social groups across Britain, extrapolated on the basis of land classes, in (a) the late 1980s, and (b) the mid-1990s	36
Figure 3.2	Survivorship curves following first capture as a cub for badgers in (a) Woodchester, (b) Wytham, (c) Bristol	43
Figure 3.3	Causes of death in badgers from 21 social groups in Woodchester Park from 1978 to 1993	44
Figure 3.4	The frequency with which <i>M. bovis</i> infection has been identified (by ELISA or culture) over the period 1981 to 1995 in 22 undisturbed social groups of badgers at Woodchester Park	47
Figure 3.5	Maps of badger territories in the Woodchester study site, showing where evidence of <i>M. bovis</i> infection was found over a five-year period	48

Chapter 4 – Spatial and temporal trends in *Mycobacterium bovis* infection in cattle and badgers

4.1	Introduction	56
4.2	Spatial and temporal patterns of herd breakdowns	56
4.3	Spatial and temporal patterns of <i>M. bovis</i> infection in badgers	60
4.4	Molecular typing of <i>M. bovis</i>	64
4.5	The use of mathematical models to understand the epidemiology of <i>M. bovis</i>	68
4.6	Possible factors underlying local patterns of infection in badgers and cattle	71
4.7	Conclusions and recommendations	74
Figure 4.1	New confirmed herd breakdowns: (a) 1987 to 1991 (inclusive), (b) 1992 to 1996 (inclusive)	57
Figure 4.2	Herds with more than one breakdown: (a) 1987 to 1991 (inclusive), (b) 1992 to 1996 (inclusive)	58
Figure 4.3	Source of 41,526 badgers submitted to MAFF for post-mortem 1972 to 1996	60
Figure 4.4	Number of MAFF-taken badgers and prevalence of <i>M. bovis</i> infection 1975 to 1996 in England and Wales	62

	Page number	
Figure 4.5	Number of road traffic accident (RTA) badgers and prevalence of <i>M. bovis</i> infection 1972 to 1996 in England and Wales	62
Figure 4.6	The relationship between the number of confirmed breakdowns and TB prevalence in road traffic accident badgers 1986 to 1990 and 1991 to 1996 in: (a) South-West England, (b) the rest of England and Wales	63
Figure 4.7	Distribution of spoligotypes in cattle (except 9 and 17)	67
Figure 4.8	Distribution of spoligotypes 9 and 17 in cattle	67
Figure 4.9	Spoligotypes of isolates taken from cattle and badgers at the same time and place	68

Chapter 5 – Control strategies

5.1	Introduction	76
5.2	What are the key features of previous control strategies that may have affected their success?	76
5.3	The live test trial	80
5.4	What was the effect of the control strategies on the prevalence of TB in badgers and on herd breakdowns?	82
5.5	Prospects for fertility control as a TB control strategy	86
5.6	A scientific approach to future control strategies	87
5.7	Husbandry	96
5.8	Conclusions and recommendations	97
Table 5.1	Important features of the four different control strategies	77
Table 5.2	Number of badgers removed by MAFF during badger removal operations (BROs) and maintenance periods and the prevalence of infection under different control strategies	82
Table 5.3	Patterns of TB infection in badgers and cattle by control strategy	83
Table 5.4	The mean time for 20% of those herds that (a) had reactor cattle and (b) that had some form of badger control (gassing, clean ring and/or interim) in the period 1975-1991 to experience a recurrence of reactors	85
Figure 5.1	The probability of obtaining at least one positive ELISA test from sampling a subgroup of ten badgers given an infection prevalence of 30% or 50%	81
Figure 5.2	Repeat and contiguous breakdowns, grouped in 10km by 10km squares, 1992 to 1996 (inclusive)	91
Figure 5.3	The number of repeat and contiguous breakdowns (1992 to 1996) for a given area	92
Figure 5.4	The number of years required for the experiment to have a 90% chance of detecting a given percentage reduction in the breakdown rate for different baseline breakdown rates in the control area	93

	Page number
Chapter 6 – TB diagnosis and vaccines	
6.1 Introduction	100
6.2 The disease in cattle and badgers	100
6.3 TB diagnosis	102
6.4 Vaccines	109
6.5 Biological control	117
6.6 Conclusions and recommendations	118
Figure 6.1 Immunological events associated with mycobacterial infection	101
Chapter 7 – Conclusions and recommendations	
7.1 The scale of the problem	120
7.2 Why does it matter?	120
7.3 The link with badgers and other wildlife	121
7.4 Field studies of badgers	122
7.5 Epidemiology of the disease in badgers and in cattle	123
7.6 Molecular typing of the infective agent	125
7.7 Modelling	125
7.8 Badger management and control strategies	126
7.9 Diagnostic tests	131
7.10 Vaccines	132
7.11 Biological control	134
7.12 Data availability	134
7.13 Research	134
7.14 Summary of recommendations	135
Appendix 1 – Consultation	138
Appendix 2 – Proportion of total herds with reactors (both confirmed and unconfirmed) 1962 to 1996	141
Appendix 3 – Key operational features of badger control strategies	142
Appendix 4 – MAFF summary of action taken in response to the Dunnet review	145
Appendix 5 – Bovine TB in other countries and information on badgers and other potential wildlife vectors	152
Appendix 6 – New unconfirmed herd breakdowns:	156
(a) 1987 to 1991 (inclusive)	
(b) 1992 to 1996 (inclusive)	
Appendix 7 – MAFF protocol – assessment criteria for determining the cause of a herd breakdown	158

	Page number
Appendix 8 – Infection in MAFF-taken badgers:	165
(a) 1975 to 1990 (inclusive)	
(b) 1991 to 1997 (inclusive)	
Appendix 9 – Infection in road traffic accident badgers:	167
(a) 1972 to 1990 (inclusive)	
(b) 1991 to 1997 (inclusive)	
Appendix 10 – Number of MAFF-taken badgers and prevalence of <i>M. bovis</i> infection 1975 to 1996 in England and Wales	169
Appendix 11 – Number of road traffic accident (RTA) badgers and prevalence of <i>M. bovis</i> infection 1972 to 1996 in England and Wales	170
Appendix 12 – Mycobacterial strain typing	171
(a) DNA molecule	
(b) Spoligotyping – an assortment of different strains from <i>M. bovis</i> isolates in Great Britain	
Appendix 13 – Distribution of badger spoligotypes	173
(a) other than 9 and 17	
(b) spoligotypes 9 and 17	
Appendix 14 – A low-cost technique for identifying social group territories	175
Appendix 15 – Analysis of the live test trial	177
Appendix 16 – Staff resource requirements for the interim and live test badger removal operations	183
Glossary	184
References	186

Executive Summary

Bovine tuberculosis (TB) is caused by the bacterium *Mycobacterium bovis* (*M. bovis*). It is currently a relatively uncommon disease in Great Britain as a whole, with new confirmed cases occurring in about 0.4% of cattle herds each year. However, the disease is becoming more common, especially in South-West England, its traditional stronghold, where new cases occur in more than 1% of herds each year, in some parts of Wales and in the West Midlands. The control of TB in cattle is a complex problem and there is no single solution. We recommend a combination of approaches on different timescales.

For affected farmers, bovine TB imposes very significant economic and welfare consequences, and for the animals involved there is also an important welfare cost. Furthermore, on behalf of the taxpayer MAFF currently spends about £16 million per year on control and related issues, including tuberculin testing carried out according to an EU directive. If the disease were to become more common, these costs would increase and there could be significant trade implications.

Human TB is primarily caused by *Mycobacterium tuberculosis*, although *M. bovis* can be involved. Currently, as a result of pasteurisation of milk and tuberculin testing of cattle, there is a negligible risk to the human population of Great Britain from *M. bovis* (32 confirmed cases in the UK in 1995); but the disease has the potential to be a significant health risk.

Cattle in other countries in Europe and elsewhere also have infections of *M. bovis*, notably New Zealand, the Republic of Ireland, Italy and Spain.

The sum of evidence strongly supports the view that, in Britain, badgers are a significant source of infection in cattle. Most of this evidence is indirect, consisting of correlations rather than demonstrations of cause and effect; but in total the available evidence, including the effects of completely removing badgers from certain areas, is compelling.

It is not, however, possible to state quantitatively what contribution badgers make to cattle infection, because the relevant data have not been collected and analysed. Collection of the relevant data, statistical analysis and the use of modern molecular techniques could resolve this question and we recommend that these should be high priorities for MAFF. Other wildlife species also carry the disease, and the possibility of some contribution from these species cannot be ignored.

Recognising the importance of badgers as a source of infection, over the past two decades, MAFF has implemented, in succession, a variety of policies for killing badgers in order to control the disease in cattle. However, it is not possible to compare the

effectiveness of these different policies; nor is it possible to compare any of them with the impact of not killing badgers at all, because there have been no proper experiments.

However, the indication is that more severe culling policies involving complete, or near complete, removal of badgers from an area, are more effective at reducing the herd breakdown rate than is less complete removal. An attempt to target the control at infected badgers only (the 'live test trial') was unsuccessful because of the low sensitivity of the test for TB in badgers.

We recommend that MAFF should set up an experiment to quantify the impact of culling badgers. The experiment, in which farmers should play a role, should involve three treatments: proactive culling of badgers, reactive culling following the identification of TB in cattle and no culling. Both of the culling policies should include lactating sows.

The experiment should be overseen and analysed by an independent Expert Group. The experiment will enable MAFF to carry out a cost-benefit analysis of killing badgers to control TB in cattle. The cumulative number of badgers killed in the five years of the experiment is unlikely to be substantially different from the number killed in the present interim policy (roughly 2,000 a year on the basis of 1996 figures). Moreover, it is likely to be significantly less than the number killed in road traffic accidents.

Detailed analysis of the spatial distribution of TB in cattle during the period 1987 to 1996 shows that in some places past history of infection is a good predictor of future risk: repeated infections and infections on neighbouring farms are principally restricted to a small number of areas in Great Britain. It is in these areas of repeated occurrence of TB that the impact of treatments involving culling badgers would be greatest and most quickly seen.

We therefore recommend that the experiment outlined above is carried out in a minimum of 30 10km by 10km highest risk areas ('hot-spots'). The precise areas to be included should be finally determined by the Expert Group. Equal numbers of hot-spots should be assigned at random to each of the three treatments.

For the remainder of the country, we recommend that no culling is carried out. Outside the hot-spot areas, the risk of repeat infection or of neighbouring farm infection is relatively low and therefore the potential benefits of culling badgers are also low. The Expert Group should, however, keep the situation under review and retain the option to recommend recruitment of additional areas into the experiment if appropriate.

Although the route of transmission from badgers to cattle is not known, simple husbandry methods to separate badgers and cattle could have a significant role in reducing risk. The current MAFF guidelines are apparently not widely heeded by the farming industry, nor has there been any attempt to ascertain the impact of husbandry on risk.

We recommend that outside the hot-spot areas the farming industry itself should take the lead in carrying out a proper experimental comparison of the impact of a small number of simple husbandry techniques. MAFF's role should be to provide advice/analysis on experimental design and results and to provide incentives to the industry to participate and subsequently to adopt best practice. Husbandry may well play an important role as part of the long-term solution.

In the long run, the best prospect for control of bovine TB is to develop a vaccine for cattle. This is a long-term (more than ten years) strategy and success cannot be guaranteed. However, targets and milestones can be identified to monitor and evaluate progress at five yearly intervals. We recommend that the development of a cattle vaccine and an associated diagnostic test to distinguish infected from vaccinated cattle should be a high priority for MAFF's long-term research strategy.

A badger vaccine, although posing greater technical problems in terms of both development and delivery, should also be kept as an option. During the next five years much of the basic research required will be relevant to both badgers and cattle.

Proper co-ordination of the research will be essential. In developing its research strategy MAFF should take into account work on human TB including genome sequencing, and work on animal vaccines and diagnostics in other countries. Industrial involvement should also be explored.

We recommend that MAFF's future strategy for research on, and control of, bovine TB should take account of the following points:

- (i) MAFF should ensure that it commissions research from the best groups in the research community;
- (ii) there should be a better co-ordination of modelling and data collection to ensure that the appropriate data are collected and that best use is made of them in analyses;
- (iii) data should be freely available to facilitate the best analysis and to engage the wider research community;
- (iv) there should be better co-ordination of MAFF-sponsored research on TB and the work of other public funders (e.g. Research Councils) and industry; and
- (v) the total amount spent on TB research (£1.7 million) as well as the relative amount (nine times more is spent on control than on research) should be reviewed in the light of the costs of TB control and the potential returns from research. The industry could contribute to the costs of control as they do in New Zealand, where the absolute amount spent on research by the Government is three times higher than in Britain and the amount of Government money spent on control is just under twice that spent on research.

1 Background

1.1 Introduction

1.1.1 The terms of reference we were given for this Review were: 'To review the incidence of tuberculosis in cattle and badgers and assess the scientific evidence for links between them; to take account of EU policies on reducing and eliminating the incidence of tuberculosis in cattle; to take account of any risk to the human population; and accordingly to review, in the light of the scientific evidence, present Government policy on badgers and tuberculosis and to make recommendations'.

1.1.2 This chapter describes the background to the issues we have been asked to consider. Section 1.2 considers the human and section 1.3 the animal health implications of bovine tuberculosis (TB). Section 1.4 charts the measures which have been taken to deal with the perceived TB threat from badgers. Section 1.5 considers briefly the legislation governing TB testing in cattle and protecting badgers and section 1.6 the international position. Section 1.7 outlines MAFF research. Section 1.8 sets out MAFF's stated objectives in relation to TB and section 1.9 summarises the conclusions and recommendations of this chapter.

1.1.3 We have sought to make this Review as open as possible and to benefit from the reservoir of expertise available on this issue. We therefore invited evidence from all interested parties and have met with many of these to discuss the issues in greater detail. Further details of the consultation carried out are at Appendix 1.

1.2 Bovine TB and human health

1.2.1 TB has affected human beings and animals throughout history. Bovine TB is caused by *Mycobacterium bovis* (*M. bovis*), a bacterium that can affect a wide range of animal species, including man. It is closely related to *Mycobacterium tuberculosis* (*M. tuberculosis*), the major cause of human TB, and detailed laboratory analysis is required to distinguish the two species. In the UK, human disease caused by *M. tuberculosis* and *M. bovis* most frequently affects the lungs, but may be associated with disease in other parts of the body.

1.2.2 Progressive disease in cattle has been attributed to *M. bovis* but not to *M. tuberculosis* in the UK. Infected cattle can spread bacteria by aerosol spray from the mouth and nose, and in other secretions, including milk. In 1934 the Committee on Cattle Disease under the chairmanship of Sir Frederick Gowland Hopkins reported that at least 40% of cows in UK dairy herds were infected with bovine TB. Transmission to humans then occurred mainly through the drinking of unpasteurised milk contaminated with the organism. In the 1930s *M. bovis* was estimated to cause about 2,000 deaths annually, accounting for approximately 6% of total human deaths due to TB (Hardie and Watson, 1992).

1.2.3 Bovine TB may be transmitted to man by animals other than cattle. Farmed deer are highly susceptible to *M. bovis*, for example, and an associated case of human infection was reported in Canada in 1990 (Fanning and Edwards, 1991). Domestic cats can also acquire bovine TB and provide another potential route for transmission to man.

1.2.4 Two interventions have been responsible for a dramatic reduction in the incidence of *M. bovis* disease in man during the second half of this century: first, the introduction of wide-scale pasteurisation of milk in the 1930s has reduced transmission from infected cattle to man. Currently, unpasteurised ('green top') milk cannot be sold for human consumption in England and Wales unless it comes from cattle belonging to a herd which is 'officially tuberculosis-free', under provisions in the Dairy (Hygiene) Regulations 1995. Secondly, the attested herd scheme and regular tuberculin testing, followed by compulsory slaughter of reactors, has reduced the level of disease in cattle.

1.2.5 Between 1993 and 1995 just over 6,000 cases of TB in humans have been notified annually in the UK. The causative organism is identified by culture in only about half of these cases and so precise figures are not available on the total number of TB cases attributable to *M. bovis*. In 1995, 32 (1%) of the 3,200 tuberculosis isolates cultured in the UK were attributed to *M. bovis* (PHLS data).

1.2.6 Individuals exposed to infected cattle risk infection by inhalation of aerosol spray, and the Health and Safety Executive recognises *M. bovis* as an occupational zoonosis with a potential risk for workers in farms and abattoirs. In South Australia, five cases of *M. bovis* infection in workers from four separate abattoirs were reported in a two year period in the 1980s (Robinson *et al.* 1988). In a further report on human infection with *M. bovis* in Australia (Georghiou *et al.* 1989), 57 out of 87 cases studied had had substantial domestic or work-related exposure to cattle. Occupation is not routinely recorded in surveillance data in Great Britain and so accurate data on *M. bovis* infection in people in cattle-associated occupations is not available.

1.2.7 The risk of transmission of bovine TB from contaminated meat is extremely small. *M. bovis* does not actively multiply on meat (in contrast to common food pathogens, such as salmonella). Raw beef is rarely consumed in this country and *M. bovis* is readily killed by cooking.

1.2.8 The majority of recent cases of human disease caused by *M. bovis* in the UK occur in older patients: 29 of the 32 cases in 1995 were in individuals over the age of 50 (PHLS data). These are probably the result of reactivation of infection acquired prior to the introduction of current control measures, rather than recent transmission.

1.2.9 Herd breakdowns are routinely notified to the proper officer of the relevant local authority, now usually the Consultant in Communicable Disease Control, who is responsible for monitoring any associated cases of human disease. Results of this surveillance indicate that recent herd breakdowns have not made a significant

contribution to the current incidence of bovine TB in man. There is, as yet, no evidence of an increased risk of human infection with *M. bovis* associated with recent increases in disease in cattle. Since 1990 there have been 17 cases of *M. bovis* infection in the Northern Region, for example, while the South-Western Region most affected by herd breakdowns has reported eight cases over the same period.

1.2.10 The risk of contracting bovine TB in the UK is very small both in absolute terms and in comparison to the risk for other diseases. According to Department of Health figures, the 1 in 2 million annual risk of contracting culture-confirmed bovine TB compares with a 1 in 20,000 risk of contracting culture-confirmed *M. tuberculosis* TB, 1 in 23,000 and 1 in 20,000 risks of contracting HIV infection and meningitis respectively and a 1 in 600 risk of contracting food poisoning.

1.2.11 However, a number of factors underline the importance of guarding against complacency in assessing the potential threat of bovine TB to human health, including the considerations set out below.

- (i) Current increases in disease in cattle may be causing asymptomatic human infections capable of reactivation in later life.
- (ii) There is an increasing number of immuno-compromised individuals (those infected with HIV, for example) with enhanced susceptibility to infection, including to bovine TB.
- (iii) Strains of *M. bovis* resistant to known drugs have developed and have caused recent outbreaks of fatal human disease in other countries.

DNA typing has linked outbreaks of multi-drug resistant bovine TB in a Madrid hospital (involving 16 HIV positive patients), a hospital in Malaga (involving 20 HIV positive patients, all of whom died less than three months after diagnosis) and a Dutch HIV positive patient who had been treated at the Malaga hospital and who subsequently died in Amsterdam (Samper *et al.* 1997). This spread both within and between hospitals shows how quickly the disease can become a public health problem.

1.2.12 In addition to the direct risks of contracting bovine TB, it is important also to remember the indirect costs in terms of health and welfare for farmers whose herds are affected and whose livelihoods are thus threatened.

1.2.13 We conclude that the current risk of human infection with *M. bovis* in Great Britain is negligible. However, the disease has the potential to cause problems and a rationale underlying policies for control of bovine TB is to ensure that this risk does not increase. We therefore recommend that the incidence of *M. bovis* TB in humans should be kept under review in the light of the increasing incidence in cattle.

1.3 Bovine TB and animal health

1.3.1 Bovine TB has serious implications for both animal welfare and animal health. In cattle it causes reduced productivity and premature death. It thus has severe economic implications for affected farms. These factors gave the impetus for the voluntary national eradication programme introduced in 1935 with voluntary tuberculin testing and incentives for herds attested free of TB. This was suspended during the war years.

1.3.2 The compulsory eradication programme began in 1950 on an area by area basis, starting with the least badly affected areas (Scottish Islands, East Anglia, Wales). Areas were declared to be 'attested' after all animals with positive tuberculin skin test reactions (so-called 'reactors') had been removed for slaughter and two successive tests of each animal had shown that all herds in the area were TB free. These attested areas provided a source of disease-free stock for restocking the worst affected areas (the dairying areas of the West and Midlands).

1.3.3 By 1960, the whole of the UK had been declared attested although the disease had not been fully eradicated: annual incidence^a had been reduced to about one herd in fifty. A continuing testing and slaughter programme further reduced this. MAFF calculate that in 1996 the annual incidence of confirmed herd breakdowns was about 0.41% in Great Britain. However, as Figure 1.1 shows, breakdowns^b have been steadily rising since 1988 in both South-West England^c and the rest of England and Wales (see also breakdown statistics for 1962 to 1996 at Appendix 2). The data on disease incidence are analysed in Chapter 4.

a 'Incidence' refers to the rate of new infection in a population.

b Figure 1.1 shows confirmed and unconfirmed breakdowns as a proportion of the total herds in South-West England and the rest of England and Wales: details of confirmed breakdowns were not available for the period concerned; nor were comparable data available for Scotland.

c 'South-West England' – this region is based on the former MAFF South-West Region encompassing Cornwall, Devon, Somerset, Dorset, Avon, Wiltshire and Gloucestershire.

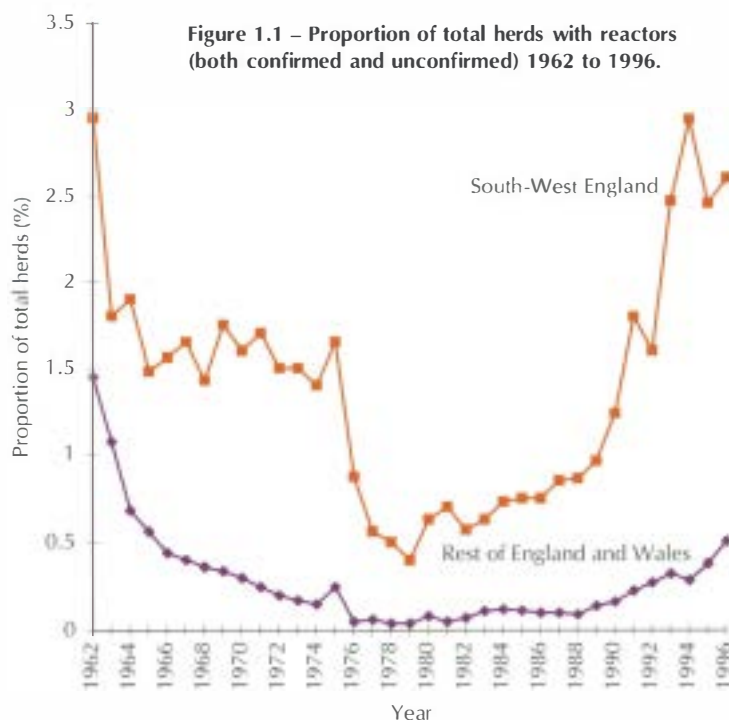

1.3.4 It became clear in the late 1960s and early 1970s that, contrary to the pattern in the rest of Great Britain, prevalence remained stubbornly high in South-West England (Fig. 1.1). Investigations into the reasons for this led MAFF to conclude that badgers were a potential reservoir of *M. bovis* infection for cattle.

1.4 Measures to tackle the TB threat from badgers

1.4.1 This section summarises the development of policies and strategies over the period since the early 1970s. Appendix 3 summarises the key features of previous control strategies and Chapter 5 analyses the effectiveness of the various strategies.

Identification of the risk

1.4.2 When it became clear that the persistence of the disease in certain areas pointed to a source of infection other than cattle, MAFF examined wildlife, including badgers, to assess their potential as reservoirs of TB infection for cattle. They found that although other species could be infected with TB, this was at low levels compared with the prevalence of the disease in the badger population (see also Chapter 2, table 2.2). MAFF concluded in 1973 that action was required to deal with infected badgers where they posed a threat to the health of cattle.

1.4.3 The Badgers Act 1973 enabled Agriculture Ministers to issue licences for the killing of badgers to prevent the spread of disease. Initially, affected farmers were permitted to kill badgers on their own farms by shooting (sometimes following trapping or snaring). However, there was concern about the welfare implications of these methods. Trapping was also considered to be too cumbersome and time-consuming. In the light of this MAFF decided that gassing setts with hydrogen cyanide was the most humane and effective method of killing badgers. Conservation and animal welfare organisations accepted this.

Gassing strategy

1.4.4 The Conservation of Wild Creatures and Wild Plants Act 1975 permitted the use of gas to be specified in licences. The Government undertook to ensure that licences to control badgers were issued only to MAFF staff or other people under MAFF control.

1.4.5 The Government also announced in 1975 the formation of the Consultative Panel on Badgers and Tuberculosis to advise MAFF on measures to deal with the problem of bovine TB in badgers. The Panel comprised representatives of interested organisations (conservation, welfare, farming and veterinary). It met for the first time in September 1975 and continues to this day, although meetings have been suspended pending the outcome of this Review.

1.4.6 Gassing operations began in August 1975 and continued with a short break (September 1979 to October 1980) during the Zuckerman review until June 1982.

1.4.7 Once a breakdown had been attributed to badgers, populations were sampled, normally up to one kilometre from the farm boundary, to identify infection status. Setts^a of infected social groups^b identified and other in-contact social groups were then gassed. However, the methodology for identifying social groups was not sufficiently rigorous to ensure that these were always precisely identified (see section 5.2). Gassed setts were revisited for up to two years after initial gassing to prevent immigrant badgers from contracting infection from contaminated setts or bringing in new infection.

1.4.8 Initially, gassing operations were subject to agreement by the occupiers of the land. New legislation was subsequently introduced (Agriculture (Miscellaneous Provisions) Act 1976; and the Badgers (Control Areas) Order 1977) providing powers of entry in four defined areas for badger investigation, surveillance and control operations. Outside these statutory areas, badger control operations were subject to the voluntary agreement of the occupier.

Zuckerman review

1.4.9 Public scepticism about the role of infected badgers in transmitting disease to cattle and criticism of the practice of gassing led to the then Minister of Agriculture asking Lord Zuckerman in September 1979 to review the problem and make recommendations. Gassing operations ceased at the start of this review until October 1980.

1.4.10 Lord Zuckerman concluded that on scientific grounds it was clear that badgers constituted a significant reservoir of bovine TB. He based this conclusion on evidence of the proportion of infected badgers and on the following key factors (Zuckerman, 1980, paragraph 45):

- (a) The infecting organism has been experimentally proved to be the same in both species – cultures made from TB lesions in cattle have infected badgers experimentally, and vice versa.
- (b) Badgers develop ‘open lesions’ and can spread the organism.
- (c) They can pass the disease on when placed in contact with clean cattle.
- (d) In areas in which infected badgers are common, the infection rate in cattle is high.
- (e) If infected badger colonies are removed, the incidence of breakdowns in cattle decreases.
- (f) The organism can persist in pasture long enough to allow of infection in cattle.’

1.4.11 He further concluded that the high density and close proximity of the cattle and badger populations in parts of South-West England favoured the transmission of the disease both from badgers to cattle and from one infected group of badgers to another and that the disease seemed to have spread since control measures had been halted in October 1979. In the light of these findings he recommended that gassing operations be

a ‘Sett’ is the name given to the burrow system which badgers use for shelter and breeding. Setts vary in size but would typically have 3-10 large entrances leading to an intricate system of interconnected tunnels and chambers.

b Badgers are social animals which live together in social groups which occupy one or more setts in well-defined territories from which other social groups would be excluded.

resumed as soon as possible and that these should be monitored to assess their impact on prevalence of the disease in cattle and badgers.

1.4.12 In accordance with another recommendation by Lord Zuckerman the concentrations of hydrogen cyanide gas needed in the air of a sett to kill badgers quickly and humanely were investigated. This investigation cast doubt on the humaneness of this method of killing because research showed that badgers did not die immediately underground. Gassing was therefore replaced in July 1982 with live trapping followed by humane killing (usually shooting). This had the advantage that carcasses were available for scientific study.

Clean ring strategy

1.4.13 Between 1982 and 1985, a 'clean ring' strategy was introduced to replace the gassing strategy. Under this strategy social groups were identified using bait-marking^a. Samples from carcasses were then taken from all setts used by these social groups. Those groups found, on laboratory examination, to be infected were totally removed, extending out to successive social groups until a clean ring of uninfected social groups was found. The techniques used meant that it was possible to define fairly precisely the geographical extent of infection. Re-establishment of badgers in the cleared area was prevented by further trapping for six months to avoid any risk of incoming badgers bringing new infection or becoming infected from any live bacteria remaining in the setts.

Dunnet review – interim strategy

1.4.14 Lord Zuckerman had recommended a review of policy three years after his report was published. In September 1984 Ministers asked Professor Dunnet to conduct this review. He reported in March 1986. The terms of reference for this review, its recommendations and a summary of action taken by MAFF in respect of each of these recommendations are set out in Appendix 4.

1.4.15 Professor Dunnet concluded that, on the basis of the evidence then available, some form of continuing badger control was unavoidable (Dunnet *et al.* 1986, paragraph 108). He therefore recommended more limited badger removal operations – the so-called interim strategy. However, he clearly envisaged this strategy operating only:

- (i) until there were sufficient further data from research and badger removal operations to enable a further substantive review (Dunnet *et al.* 1986, paragraphs 107 and 143); and
- (ii) in the expectation of the development of a reliable and effective diagnostic test for TB in living badgers within about five years (Dunnet *et al.* 1986, paragraphs 118 to 120).

1.4.16 Professor Dunnet recommended the development of the diagnostic test in living badgers (the 'live test') both as an aid to research and as a more discriminatory and acceptable strategy for badger control: it would enable only infected badgers to be

^a 'Bait-marking' is used to define social group territories by placing coloured plastic chips in palatable food at sett entrances using a different colour at each main sett and then recording the latrines in which particular colours of chips are found in faeces.

killed. He considered that targeting culling on infected animals would also avoid some of the disruption to social groups seen by blanket removals.

1.4.17 Crucially, the live test was also seen as providing, for the first time, the possibility of a reliable means of determining the infection status of badgers without killing badgers. This in turn would potentially facilitate a proactive badger control strategy rather than the previous reactive ones.

1.4.18 The interim strategy was intended to offer a means of controlling badgers on infected farms pending the development of the live test. However, it remains the main control method. It restricts badger removal operations to that part of the breakdown farm where it is believed the disease was transmitted to cattle or to the whole farm if it is impossible to be more precise. Operations may not, however, extend beyond the breakdown farm. Badgers are killed by cage-trapping and shooting. The carcasses are then removed for post-mortem examination and laboratory culture of samples. The removal operation ceases when there is no further sign of badger activity on the reactor land. Since the end of 1989 there has been no subsequent automatic revisiting arrangement to remove any immigrant badgers.

1.4.19 The decision on whether a badger removal operation is warranted is taken by senior officials in cases where a confirmed breakdown has been attributed to badgers and where the breakdown occurs in a parish where there has been infection in cattle attributed to badgers in the past six years (a type I parish). However, in parishes where there has been no recent history of TB attributed to badgers (a type II parish), the procedure requires a badger survey to be carried out first and for this and other veterinary evidence to be presented to a subgroup of the Consultative Panel on Badgers and Tuberculosis (the 'mini-Panel'). The mini-Panel would determine whether the evidence warranted a badger removal in these cases.

1.4.20 The Dunnet report recognised that these more limited controls on badgers might not be sufficient to prevent a rise in breakdowns. Upper limits for the levels of future breakdowns were therefore specified. The report envisaged that if 'the mean annual incidence of breakdowns over the next three years exceeded 1.45% of herds, or 1.25% over the next five years' a review of the interim strategy would be triggered (Dunnet *et al.* 1986, paragraph 113). Unfortunately, it is not clear to what area these benchmarks were intended to apply and they do not therefore appear to have had any practical effect.

Six point plan

1.4.21 There was no formal review of the new strategy in the six years following the Dunnet report. However, in 1993 in the light of mounting concern about the increasing numbers of breakdowns, and taking account of advice from the Consultative Panel, Ministers agreed a six point plan. This comprised:

- (i) a major 10-15 year research programme to develop a badger vaccine;

- (ii) research on a blood test to improve the efficiency and cost-effectiveness of diagnosis in cattle;
- (iii) wildlife monitoring: veterinary epidemiological investigations into cattle breakdowns include wildlife monitoring in the vicinity. A national survey to investigate the incidence of TB in badgers killed in road traffic accidents had taken place between 1986 and 1990 but was then discontinued because of lack of funds;
- (iv) a focus on transmission studies;
- (v) research on badger disturbance to monitor the effects of a live test badger removal operation on badger movements and cattle disease; and
- (vi) a comparative trial of the live test (see below).

These and other research priorities are considered in the following chapters.

Live test trial

1.4.22 MAFF began a trial of the blood test for live badgers in November 1994. The aim was scientifically to evaluate the live test approach against the interim removal strategy by running the two in parallel for five years. The trial focused on the high risk areas in South-West England. It was envisaged that it would cover 4,000 herds surrounding breakdown farms and at risk from the same badgers as could have caused these breakdowns.

1.4.23 Because of the poor sensitivity^a of this test when applied to individual animals (it identifies only 41% of infected badgers) it was decided to apply the test to populations of badgers at sett level. This increased the sensitivity, albeit with a loss of some specificity^b (i.e. slightly more negative badgers were identified as positive).

1.4.24 In the event the live test trial ran only for 18 months before being suspended pending the outcome of this Review. Although no firm conclusions could be drawn from the trial at that point, MAFF was clear at that stage that some fundamental alterations to the trial design would be necessary if it were to be reinstated. A more detailed description and analysis of the trial is contained in section 5.3 and Appendix 15.

1.5 Legislative position

Tuberculin testing

1.5.1 EU Directive 64/432/EEC (to be superseded by Directive 97/12/EC with effect from 1 July 1998) lays down the requirements for tuberculin testing of cattle. This includes the minimum testing frequency for cattle which depends on the percentage of infected cattle herds. Annual testing is required unless the percentage of infected herds in the member state or region of a member state (currently defined as county, or larger area, in Great Britain) is 1% or less over a specified reference period, when testing may be carried out at two year intervals. Where the percentage of infected herds is 0.2% or

^a 'Sensitivity' refers to the proportion of infected animals correctly identified.

^b 'Specificity' refers to the proportion of uninfected animals correctly identified.

less or 0.1% or less over a specified reference period, testing may be carried out at three or four year intervals respectively.

1.5.2 Most areas of Great Britain meet the criterion for four-yearly testing. Testing frequency would increase if the percentage of infected herds exceeded the thresholds described above. At the time of the Review, the annual herd breakdown rate was rising, with new areas being affected. A reassessment was being made of testing frequency in the light of this and of the EU legislation, with the possibility of additional regions with higher incidence moving to more frequent testing. Any such changes would considerably increase the current total of about £11 million a year spent on testing. Increased incidence could also, in principle, have significant trade implications.

Badger legislation

1.5.3 The Badgers Act 1973 was the first badger protection legislation in Great Britain. It introduced offences for the taking, injuring or killing of badgers. There were certain exemptions enabling authorised persons (for example, land-owners) to kill or take badgers on their land and Ministers to issue licences for killing or taking badgers to prevent disease spread. The exemptions for authorised persons were removed by the Wildlife and Countryside Act 1981. Effectively this meant that killing badgers was legitimate only under licence issued by Ministers.

1.5.4 The legislation was successively tightened with specific provision for the protection of setts introduced by the Badgers Act 1991. The Protection of Badgers Act 1992 consolidated the earlier legislation. It retains the key provision enabling Agriculture Ministers to issue licences to kill or take badgers, or to interfere with a badger sett within a specified area, for the purpose, among others, of preventing the spread of disease. However, licences are not issued for disease control purposes. MAFF carries out all this work itself and relies on Crown immunity under the relevant legislation.

1.5.5 Section 11(1) of the Wildlife and Countryside Act 1981 prohibits self-locking snares for the killing or taking of any wild animal. More generally, all forms of snaring and trapping are prohibited for badgers and certain other animals. However, Ministers may issue licences permitting the use of snares and other trapping methods prohibited by these provisions where they are satisfied that this would be appropriate. The legislation requires snares to be checked daily.

1.5.6 All wild mammals have a certain level of legal protection: for example, the Wild Mammals Protection Act 1996 makes it an offence to commit certain acts of cruelty against wild mammals. Badgers are not an endangered species and the badger protection legislation confers on badgers a degree of protection which is beyond that necessary to preserve their current distribution.

1.6 The international picture

1.6.1 In conducting this Review we have sought to learn from experience in other countries. Information on bovine TB and wildlife reservoirs in other countries is often difficult to obtain. Appendix 5 summarises information compiled by MAFF on bovine TB in EU and some other countries. It is not exhaustive: an in-depth study of bovine TB controls throughout the world would be a different and more lengthy task than the one we have been assigned. However, the key point is that bovine TB is not a uniquely British problem.

1.6.2 Given the complexity of the disease, it is important to learn from experience in other countries.

1.7 MAFF research

1.7.1 MAFF's £1.7 million TB research budget in 1997/98 focuses on three main areas as illustrated in Figure 1.2:

- (i) research to improve understanding of TB in badgers and how badgers can be prevented from transmitting *M. bovis* infection to cattle (43%);
- (ii) developing better diagnostic tests for cattle (31%); and
- (iii) developing a vaccine for badgers (26%).

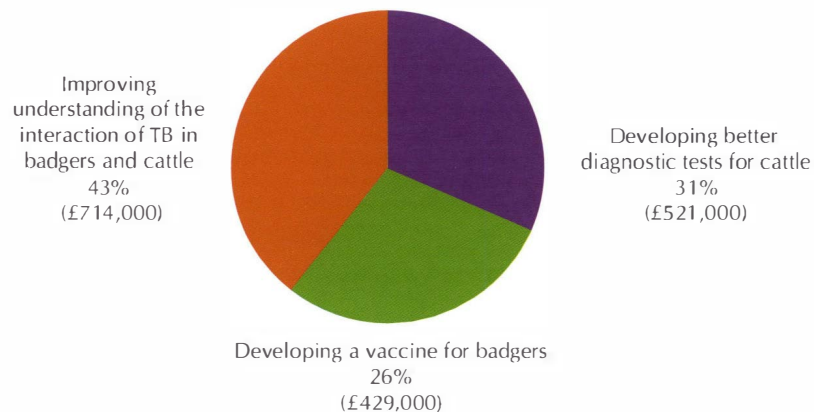

Figure 1.2 – MAFF TB research expenditure 1997/98.

Note: figures as at 1 September 1997.

1.7.2 As is shown in Figure 1.3, only 5% of research is currently contracted out with the rest carried out by the Veterinary Laboratories Agency (75%) and Central Science Laboratories (Woodchester Park – 20%). We do not consider that this apportionment reflects that the best use is being made of available expertise. We recommend MAFF should ensure in future that research is commissioned from those with the best expertise from throughout the UK research community. We also recommend that MAFF should consider partnerships with industry, universities and other funding agencies to develop a

better co-ordinated approach. These points are essential to ensure best value for money is achieved for the limited resources available.

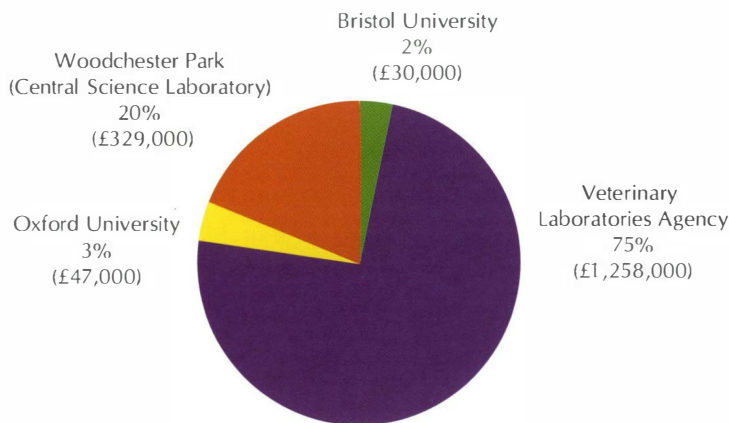

Figure 1.3 – MAFF TB research expenditure 1997/98 by contractor.

Note: figures as at 1 September 1997.

1.7.3 Over nine times as much money is spent on TB control (£16 million a year) as is spent on TB research (£1.7 million a year) by MAFF. The money spent on research is very small given the economic cost of the disease and the uncertainties that surround many key issues. It contrasts with the position in New Zealand where the absolute amount spent on research is nearly three times as high (NZ\$10.9 million or £4.7 million) and the amount spent by the Government on control is just under twice (NZ\$20.1 million) that spent on research. One significant difference between New Zealand and Great Britain is that the New Zealand Government pays less than half of the costs of their TB control measures.

1.7.4 In this country the Government pays for all the TB controls. Given the need for substantial continuing research in this area, we recommend that the Government should review the amount spent on research in absolute terms and consider whether the allocation of resources between research and control costs is correct and the extent to which it would be reasonable for the main beneficiaries (the farmers) to contribute to control costs from which they benefit directly.

1.8 MAFF objectives

1.8.1 MAFF's stated objective in relation to TB is:

- (i) 'to maintain the Tuberculosis... Free official status of British cattle... and
- (ii) to reduce the number of outbreaks by regular testing of all herds and compulsory slaughter, with compensation' (MAFF/IB Departmental Report 1997).

The Review Group has been told that in practice the aim is to meet the criterion for four-yearly testing for all herds. With the current pattern of increasing incidence, this is an ambitious objective. This Report sets out what we consider must be done to identify and address the extent of badger involvement in TB in cattle and so to assist in meeting this objective.

1.9 Conclusions and recommendations

1.9.1 Bovine TB is *currently* a negligible risk to human health in Britain. However, the disease has the *potential* to cause problems. The incidence of *M. bovis* TB in humans should therefore be kept under review in the light of the increasing incidence of the disease in cattle (section 1.2).

1.9.2 Bovine TB has severe economic implications for affected farms. Its implications for animal welfare and health also warrant high priority being given to reducing the incidence of the disease (section 1.3).

1.9.3 The increasing incidence of the disease could necessitate more frequent testing of cattle with substantial implications for public expenditure. It could also, in principle, have implications for trade (paragraphs 1.5.1 and 1.5.2).

1.9.4 Badgers are not an endangered species and the badger protection legislation confers on badgers a degree of protection which is beyond that necessary to preserve their current distribution (paragraph 1.5.6).

1.9.5 Bovine TB is not a uniquely British problem. It is therefore important to learn from experience in other countries (section 1.6).

1.9.6 The relatively small amount of research currently contracted out does not reflect that best use is being made of available expertise. MAFF should ensure that research is commissioned from those with the best expertise from throughout the UK research community. MAFF should also consider partnerships with industry, universities and other funding agencies to develop a better co-ordinated approach (paragraph 1.7.2).

1.9.7 The money spent on research is small given the economic cost of the disease and the uncertainties surrounding many key issues. The Government should review the amount spent on research in absolute terms and consider whether the allocation of resources between research and control costs is right and the extent to which it would be reasonable for the main beneficiaries (the farmers) to contribute to control costs from which they benefit directly (paragraphs 1.7.3 and 1.7.4).

2 Evidence for the transmission of *Mycobacterium bovis* from badgers to cattle

2.1 Introduction

2.1.1 This chapter assesses the evidence on transmission to cattle in Great Britain of *M. bovis* infection in badgers and rigorously examines possible alternatives to the badger as a source of TB in cattle. In section 2.2 we consider the possible impact of other wildlife species and how this might be evaluated. Section 2.3 considers the scope for transmission between cattle and from other species to cattle. Sections 2.4 and 2.5 respectively analyse the evidence of *association* between *M. bovis* in badgers and TB in cattle and of *transmission* from badgers to cattle. Section 2.6 summarises the conclusions and recommendations.

2.1.2 In analysing the data available on *M. bovis* infection in badgers and cattle, it is important to distinguish between evidence of an *association* between *M. bovis* infection in badgers and in cattle and evidence of *transmission* of *M. bovis* from badgers to cattle. Transmission of *M. bovis* from badgers to cattle would result in an association; but such an association could also arise from transmission of *M. bovis* from cattle to badgers, or from transmission of *M. bovis* to cattle and badgers from a common source.

2.1.3 Data supporting an association between *M. bovis* infection in badgers and herd breakdowns are strong. The data supporting the transmission of *M. bovis* from badgers to cattle are much weaker. However, the analysis in the sections below sets out our reasons for considering that transmission of *M. bovis* from badgers to cattle is the most likely cause of the observed association and thus plays an important role in the TB problem in British cattle.

2.2 Badgers and other potential wildlife reservoirs for *M. bovis*

2.2.1 The badger is just one of several wildlife species that are infected with *M. bovis*. To establish the potential importance of these species in transmitting infection to cattle, several factors must be taken into account for each species including:

- (i) prevalence of *M. bovis* infection;
- (ii) the severity of the disease and its effect on infectivity;
- (iii) abundance of the species; and
- (iv) the extent of contact with cattle including the movement range of the wildlife.

These four factors are explored in more detail below.

Prevalence

2.2.2 No infections were detected in the species set out in Table 2.1, examined in connection with MAFF investigations between 1971 and 1986.

Species	Number sampled
Bat (<i>Pipistrellus pipistrellus</i>)	1
Cats (<i>Felis catus</i>)	25
Ferrets (<i>Mustela putorius furo</i>)	25
Grey squirrels (<i>Sciurus carolinensis</i>)	178
Hares (<i>Lepus capensis</i>)	14
Harvest mice (<i>Micromys minutus</i>)	3
Hedgehogs (<i>Erinaceus europaeus</i>)	23
Polecats (<i>Mustela putorius</i>)	8
Rabbits (<i>Oryctolagus cuniculus</i>)	144
Shrews (<i>Sorex spp</i>)	135
Stoats (<i>Mustela erminea</i>)	33
Voles (<i>Clethrionomys glareolus, Microtus agrestis</i>)	875
Weasels (<i>Mustela nivalis</i>)	33
Woodmice (<i>Apodemus sylvaticus</i>)	744
Yellow necked mice (<i>Apodemus flavicollis</i>)	73
Other small unidentified rodents	166

Table 2.1 – Wildlife examined and not detected to be infected with *M. bovis* 1971 to 1986.

Source: Bovine Tuberculosis in Badgers, 11th Report, MAFF, 1987, Appendix 8, part II.

2.2.3 Over the period 1971 to 1995, Table 2.2 shows that MAFF investigations detected *M. bovis* in the following species other than badgers: moles (*Talpa europaea*); foxes (*Vulpes vulpes*); mink (*Mustela vison*); rats (*Rattus norvegicus*); wild deer (red: *Cervus elaphus*; roe: *Capreolus capreolus*; fallow: *Dama dama*; and sika: *Cervus nippon*); and ferrets (*Mustela putorius furo*). Although the prevalence of *M. bovis* in the sampled badgers (*Meles meles*) is higher than in the other sampled species, the sample suffers from unquantifiable biases (see also section 4.3).

Species	<i>M. bovis</i> infection prevalence	Number sampled
Mole (<i>Talpa europaea</i>)	1.21%	166
Fox (<i>Vulpes vulpes</i>)	1.15%	954
Mink (<i>Mustela vison</i>)	0.58%	172
Rat (<i>Rattus norvegicus</i>)	1.21%	412
Wild deer: red (<i>Cervus elaphus</i>), roe (<i>Capreolus capreolus</i>), fallow (<i>Dama dama</i>), sika (<i>Cervus nippon</i>)	1.05%	1,817
Ferret (<i>Mustela putorius furo</i>)	3.85%	26
Badger (<i>Meles meles</i>)	4.05%	21,731

Table 2.2 – Prevalence of *M. bovis* infection in infected wildlife.

Wild and feral species other than badgers were sampled by MAFF between 1971 and 1995. The sample of badgers presented here are those submitted by the public between 1972 and 1994.

Source: MAFF Annual Reports on Bovine Tuberculosis in Badgers.

2.2.4 Studies carried out in New Zealand have found that *M. bovis* prevalence is higher in ferrets sampled on farms with a history of TB infection in cattle than on farms with no record of herd breakdowns (17.9% compared with 0%). This association led to the suggestion that ferrets might transmit TB to cattle in New Zealand (Ragg *et al.* 1995b). As in the case of badgers, such an association could also arise from transmission of TB from cattle to ferrets or to cattle and ferrets from a common source. However, ferrets are dealt with as a wildlife reservoir of bovine TB in certain parts of that country.

2.2.5 Ferrets are domesticated polecats and occur as feral populations in Great Britain. Wild polecats also exist in parts of Britain and the population is increasing. Only eight were sampled between 1971 and 1986 and none were found to be infected. Although the population density is low, recent studies show that in winter they spend a large proportion of their time in and around farm buildings. Few ferrets have been sampled in Britain, and only one was found to be infected, resulting in the relatively high prevalence of infection recorded in Table 2.2. We recommend that more data should be collected on both polecats and ferrets to estimate the infection prevalence more precisely as part of the assessment of risk recommended in paragraph 2.2.10.

Severity of the disease and infectivity

2.2.6 Only animals that actively shed bacteria are infectious. Badgers in the late stages of TB disease often have severe lesions, from which bacteria are excreted, in (see also paragraphs 3.4.1 to 3.4.6):

- (i) sputum, if the lungs are infected;
- (ii) faeces, when sputum is swallowed;
- (iii) urine, if the kidneys are infected; or
- (iv) pus, often from infected bite wounds.

Both ferrets and deer may exhibit severe lesions which could potentially discharge infectious material (Clifton-Hadley and Wilesmith 1991; Ragg *et al.* 1995a). Apart from badgers, deer and ferrets, the pathology of infected wildlife has indicated only lesions which do not shed bacteria (MAFF, personal communication).

Abundance of the species

2.2.7 A national survey in the 1980s (Cresswell *et al.* 1990) estimated that the overall population of badgers in the UK was about 250,000. A further census in 1997 suggests that the number of badgers has increased substantially between 1988 and 1997 (Wilson *et al.* 1997). If the abundance of another species were, say, an order of magnitude higher than the badger, that species could potentially be just as significant a reservoir as badgers, even with a lower prevalence. Thus, intense sampling would be necessary to detect a low level of infection and hence determine the potential risk from a highly abundant species.

2.2.8 We recommend that population densities for potential reservoir species should be obtained in the geographic areas where herd breakdowns are persistent. National average densities will not suffice for species with widely varied densities. For example, the density of badgers is much greater in South-West England than in many parts of Britain.

Extent of contact with cattle

2.2.9 Badgers favour grazed pasture while foraging for earthworms, when they also deposit urine, faeces and sputum on the grass (White *et al.* 1993; Hutchings and Harris 1997). There is the possibility, therefore, that cattle could come into direct contact with badgers and *M. bovis* excreted by badgers into their shared environment. Possible routes of infection are discussed later. However, cattle could also come into contact with other wildlife species where their ranges overlap. We conclude that the extent of cattle contact with other species needs to be characterised.

Assessing the risk

2.2.10 Clearly, species with higher infection prevalences, more shedding of bacteria when infected, greater abundance and greater contact with cattle will have more potential to transmit *M. bovis* to cattle. We therefore recommend that the risk to cattle from other species should be assessed in areas of high herd breakdown risk taking account of the four factors analysed above.

2.3 Transmission of *M. bovis* from cattle to cattle and other species

2.3.1 Prior to 1950 when compulsory tuberculin skin testing of cattle began (see paragraph 1.3.2), extensive pathology and excretion of large numbers of bacteria were a common occurrence in cattle. However, as a result of routine skin testing (see paragraphs 6.3.3 to 6.3.15) and culling of infected cattle, most infected cattle are detected early in the course of the disease. Excretion of large numbers of bacteria is

believed to be uncommon, reducing the probability of transmission from infected cattle to cattle and other contact species (Wilesmith and Williams 1986; Griffin 1993).

2.3.2 Studies have shown that *M. bovis* may be detected in the trachea, nasal mucus and nasal pharynx of skin test negative animals in the absence of visible lesions (Neill *et al.* 1992; Neill *et al.* 1994b). Such animals are likely to be in the early stages of infection since skin test reactivity is considered to take only 30-50 days to develop after infection (Francis 1947). Present evidence suggests that although some recently infected cattle do excrete *M. bovis*, transmission to other cattle is not common (Griffin and Dolan 1995).

2.4 Evidence of association between *M. bovis* in badgers and TB in cattle

2.4.1 Badgers infected with *M. bovis* are often found in areas of high herd breakdown rates (see paragraph 4.3.6). However, the distribution of infection in badgers is much more widespread than these areas: TB is also found in badgers where herd breakdowns are not common.

2.4.2 The proportion of badgers infected with *M. bovis* is generally high in areas of high herd breakdown rates (see section 4.3). However, only limited data are available on prevalence for low breakdown areas and biases in the data make it difficult to separate out spatial and temporal trends in *M. bovis* infection in cattle and badgers.

2.4.3 Molecular typing of *M. bovis* isolates taken from badgers and cattle at the same time and place show that within the same area, badgers and cattle often share a common strain^a of *M. bovis*, but that different combinations of strains are found in different areas (see paragraphs 4.4.7 to 4.4.11).

2.4.4 In Northern Ireland, there is a positive association between the number of badgers per square kilometre and the number of visible lesion reactors per square kilometre. The average number of active setts per farm is greater for all herds with confirmed TB breakdowns. There is a significant association between the number of active main setts and the risk of a TB breakdown. Although purchased cattle account for 15-20% of all breakdowns, the presence of dead badgers or badger setts is associated with 41% of the remaining breakdowns (O. Denny, personal communication).

2.4.5 Contiguous confirmed outbreaks are also an important risk factor for herd breakdowns in Northern Ireland (associated with 43% of breakdowns not associated with purchased cattle). However, infected badgers may also be responsible for at least some of these outbreaks: preliminary analysis by DANI shows that herds with a badger sett on the premises are more likely to have a contiguous neighbour with confirmed TB, irrespective of their own status (O. Denny, personal communication). Thus 41% may underestimate the proportion of breakdowns which are truly associated with badgers. A similar analysis for England and Wales would require more intensive badger surveys

^a A 'strain' is an isolate of a bacterial species which is differentiated from other isolates of the same species by particular characteristics.

to be carried out than at present. We recommend that the necessary data should be collected to enable the contribution of badgers to risk of TB to be properly assessed (see paragraphs 4.2.6, 4.2.7, 4.6.9, 4.6.16 and 4.6.17).

2.4.6 In summary, we conclude that there is strong evidence for an association between TB in badgers and cattle.

2.5 Evidence of transmission of *M. bovis* from badgers to cattle

Can badgers transmit *M. bovis* to cattle?

2.5.1 A laboratory study found that calves developed sensitivity to bovine tuberculin after six months' exposure to experimentally and naturally infected badgers (Little *et al.* 1982). Cattle can thus acquire *M. bovis* infection from badgers under unnatural experimental conditions. These did not mimic natural conditions, in that cattle and badgers were kept in a concrete-lined cattle yard, where the badgers slept in a metal pig sty. Whilst the experiment could not measure the likelihood of transmission from badgers to cattle in field conditions nor identify the route of transmission, it did demonstrate that under extreme conditions it is possible for badgers to transmit *M. bovis* to cattle.

What may be the transmission route of *M. bovis* from badgers to cattle?

2.5.2 Although direct contact between cattle and healthy badgers may be unlikely, important behavioural changes may occur when badgers are near death due to TB (Cheeseman and Mallinson 1981) which may bring infectious badgers and cattle into direct contact. Given that herd breakdowns are relatively rare, direct contact between infected badgers and cattle, resulting in inhalation or ingestion of bacteria, cannot be ruled out.

2.5.3 Another possible route of transmission is by cattle coming into contact with faeces, urine and sputum of infectious badgers (see paragraph 3.4.6). Survival times for the bacteria may vary considerably (see paragraph 3.5.3). Since cattle smell by first exhaling strongly, thus creating an aerosol, it has been suggested that simply investigating an infected area might be sufficient for inhalation of the bacteria.

2.5.4 We conclude that transmission of *M. bovis* from badgers to cattle in the field is theoretically possible, although the route of transmission is as yet unknown. Research into transmission routes is highly desirable. It would be particularly important for developing effective control strategies based upon reducing badger-to-cattle transmission by changing cattle husbandry practices. It would also contribute to understanding local variation in risk. We recommend that further consideration should be given to whether appropriate techniques can be developed to research this issue.

What are the effects of badger culling?

2.5.5 A reduction in the incidence of TB in cattle in areas after badger clearances would be compelling evidence that the badgers had been responsible for TB in the cattle, if alternative explanations could be eliminated. The impact of badger control is discussed in more detail in Chapter 4 and is summarised below.

2.5.6 Four large-scale badger clearances have been carried out, at Thornbury in Avon (104km²), at Steeple Leaze in Dorset (12km²), at Hartland in North Devon (about 62km²) and in an area of East Offaly in the Irish Republic (738km²). All four clearances were followed by a reduction in the incidence of TB in cattle.

2.5.7 At Thornbury, all badgers were systematically removed from 1975 to 1981, after which recolonisation was allowed. The incidence of TB in cattle fell from 5.6% in the 10 years prior to the clearance, to 0.45% in the 15 years following the clearance (Clifton-Hadley *et al.* 1995b; R. Clifton-Hadley, personal communication). There are no comparable data from areas with similar geographical characteristics and disease incidence but without badger removals because Thornbury 'was not conceived as a scientific experiment but as a means to control the spread of tuberculosis from badgers to cattle' (Clifton-Hadley *et al.* 1995b).

2.5.8 At Steeple Leaze, there were no herd breakdowns for seven years (1978 to 1984) following badger clearance (the main clearance was in 1975/76 with regassing until February 1979), whilst in the six years before the removal 626 reactor and exposed cattle had been slaughtered in repeated breakdowns on a single farm (Wilesmith *et al.* 1982).

2.5.9 A large area of the Hartland Peninsular, with good natural boundaries (the sea to the west and the river Tamar to the east), was cleared of badgers in 1984. Following the clearance, all herds were tested. The clearance resulted in a drop in herd breakdown rate from about 15% in 1984 to about 4% in 1985. This improvement was sustained for nearly ten years.

2.5.10 At East Offaly, badger removal began in 1989 and continued through 1995. The incidence of TB in cattle fell in the experimental removal area, but it also fell in the surrounding area of 1,456km², where limited removals took place in response to breakdowns. The breakdown rates (calculated as the number of reactors per 1,000 tests – incidence figures are not available) between 1988 and 1995 fell from 3.91 to 0.46 in the removal area, compared with from 3.39 to 2.10 in the surrounding area.

2.5.11 The results from all these removal operations demonstrate the importance of establishing adequate experimental controls. Badger removal might have caused the observed fall in herd breakdown rates, but the possibility remains that some other unidentified factor could have been responsible. Selecting equal numbers of badger removal and control sites randomly from a sufficiently large pool of similar sites would eliminate such alternative explanations. The control sites would allow examination of

natural changes over time, giving insight into what would have occurred at the badger removal sites had no intervention taken place.

2.5.12 A trial is being conducted in the Republic of Ireland, where four areas have been selected based upon a higher than average prevalence of cattle TB over the past three to five years and the presence of boundaries which may curb immigration of badgers into the removal areas. Each of the four areas consists of one area designated for complete removal of badgers and one area where more limited removals (similar to the interim strategy removals in Great Britain) would take place in the event of herd breakdowns. Badgers are caught by stop-snares, which avoids the problem of trap shy badgers and facilitates removal over a large area. Proactive removal areas are visited twice yearly to prevent recolonisation. The study, the largest field trial in Europe to date, will be reviewed in December 2002.

2.5.13 Using a geographical information system to analyse confirmed breakdowns for the period 1986 to June 1992, it was shown that the odds of a 'badger-related' breakdown occurring (see paragraphs 4.2.5 and 4.2.6) decreases as the distance to the nearest past badger control increases (Clifton-Hadley 1993).

2.5.14 Molecular data of the type currently being collected by MAFF may also help to identify transmission of *M. bovis* between animals of the same species and of different species. A time series of isolates showing a strain appearing in only one wildlife species, followed by the same strain appearing later in nearby cattle would be strong evidence of transmission from that species to cattle (assuming that all wildlife species present were sufficiently sampled).

	Total isolates	Spoligotypes ^a
Badger	381	17
Cat	14	5
Cow	1,739	25
Deer	5	2
Fox	2	1
Goat	1	1
Human	2	2
Unknown	5	3

^a 'Spoligotype' refers to a particular strain identified through a molecular typing technique called spoligotyping (see Chapter 4).

Table 2.3 – The number of isolates and 'spoligotypes' taken from humans, cattle and wildlife 1988-1997.
Source: MAFF

2.5.15 Badgers and cattle in the same area are often infected with the same strain of *M. bovis* (see paragraph 4.4.11). However, samples for molecular analysis are currently too sparse in time and space and do not cover other wildlife species intensively (see Table 2.3) to enable firm conclusions to be drawn. In addition, strain differentiation is

relatively poor. However, further research in this rapidly changing field should help improve this situation, as should using different techniques in combination. We recommend a well-designed, intensive study over restricted areas to analyse the spatial and temporal dynamics of the disease in badgers and other wildlife as well as cattle (see paragraph 4.4.12).

2.5.16 We conclude that data showing decreases in herd breakdown rates following periods of badger removal are consistent with badgers transmitting *M. bovis* to cattle. However, due to the lack of adequate controls we cannot definitively conclude from current badger removal data that badgers are an important source of *M. bovis* infection to cattle.

2.6 Conclusions and recommendations

2.6.1 There is strong circumstantial evidence to suggest that badgers represent a significant source of *M. bovis* infection in cattle. The strongest evidence comes from the four cases in large areas of high herd breakdown incidence where herd breakdown rates were lower following badger removal. Other evidence is as follows.

- (i) Transmission of *M. bovis* from badgers to cattle can occur under certain laboratory conditions.
- (ii) There are associations between spatial and temporal patterns of *M. bovis* infection in badgers and in cattle, although biases in the data make it difficult to draw firm conclusions from these (see section 4.3 for a more detailed analysis).
- (iii) Infected badgers in the wild can shed large numbers of bacteria.
- (iv) Badgers and cattle in the same area are often infected with the same strains of *M. bovis*.

2.6.2 However, the causal link between *M. bovis* infection in badgers and herd breakdowns has not been proven as:

- (i) no controlled, randomised experiments have been carried out in natural situations; and
- (ii) sampling of isolates for molecular analysis is, as yet, too infrequent and does not adequately cover other wildlife species.

Nevertheless, the strength of the circumstantial evidence leads us to conclude that transmission from badgers is likely to be a significant contributor to the TB problem in British cattle.

2.6.3 The potential for transmission of *M. bovis* to cattle from wildlife species other than badgers appears to be extremely small since all of the infected animals sampled (apart from deer and ferrets) have lesions which do not shed bacteria. Nonetheless, the

possibility of other wildlife species acting as reservoirs of infection should be kept under scrutiny (see paragraph 2.6.4 (iii) below).

2.6.4 Further research is needed to quantify the contribution of badgers to the risk of TB and to determine the effectiveness of strategies to reduce risk. In particular:

- (i) A quantitative analysis should be carried out along the lines of the DANI case-control study (paragraphs 2.4.4 and 2.4.5).
- (ii) Intervention studies should have control as well as intervention areas to allow a meaningful comparison of pre- and post-intervention conditions (paragraph 2.5.11 and Chapter 5).
- (iii) All wildlife species should be assessed in areas of high herd breakdown incidence as potential transmission risks to cattle on the basis of (paragraphs 2.2.1 to 2.2.10):
 - (a) prevalence of infection;
 - (b) the severity of the disease and its effect on infectivity;
 - (c) abundance; and
 - (d) the extent of contact with cattle.
- (iv) Modern molecular strain typing techniques should be used on longitudinal samples from cattle, badgers and other wildlife over restricted areas to trace strain transmission. In principle this will provide definitive conclusions on the role of transmission of *M. bovis* from badgers to cattle in natural field conditions (paragraph 2.5.15 and section 4.4).

3 TB in badgers

3.1 Introduction

3.1.1 This chapter reviews our understanding of the distribution of TB in badgers, both in the UK and in other countries (section 3.2). In section 3.3 we describe those aspects of the structure of badger populations and badger behaviour likely to influence the transmission and prevalence of the disease, and in section 3.4 we describe patterns of TB infection in badger populations. Section 3.5 considers the conditions likely to facilitate transmission of TB from badgers to cattle. In section 3.6 we discuss the effects of past TB control policies on badgers and section 3.7 summarises conclusions and recommendations.

3.2 Prevalence, distribution and history of badger TB in Europe

3.2.1 Bovine TB is a recurring problem in cattle in several countries, but it is only in Great Britain and the Republic of Ireland that badgers are recognised as the principal wildlife reservoir (Caffrey 1994; Morris *et al.* 1994). The presence of such a reservoir was first suspected in the early 1970s, when the incidence of TB in cattle in South-West England had been roughly constant for 10 years, despite the repeated testing of cattle and slaughter of reactors. This suggested that cattle were being re-infected from some outside source. Around the same time, the incidence of TB in cattle in New Zealand was showing a similar pattern, and extensive surveys of wild and domestic species there showed that the possum (*Trichosurus vulpecula*) was the most likely reservoir (Morris *et al.* 1994).

3.2.2 In Britain, the role of badgers was first recognised in 1971, when a badger was found dead from generalised TB on a farm in Gloucestershire where bovine TB had recently been confirmed in cattle. Subsequent studies have shown that the prevalence of TB in badgers is consistently higher than that in other British wild and feral mammals (see paragraphs 2.2.2 and 2.2.3 and Tables 2.1 and 2.2), supporting the view that badgers are the most likely reservoir host for the infection.

3.2.3 Badgers have also been implicated in herd breakdowns outside of Britain. TB has been isolated from badgers from all of the counties of the Irish Republic, and also from Northern Ireland (Dolan and Lynch 1992). Elsewhere in Europe, TB has been confirmed in badgers only in Switzerland, and this case was attributed to contact with infected roe deer (Bouvier *et al.* 1957). Spain and Italy have a relatively high incidence of TB in cattle (FAO figures; Caffrey 1994), and reasonably high density badger populations (Griffiths and Thomas 1993), but there have been no systematic surveys of TB in wildlife in these countries (see Appendix 5).

3.2.4 Within Britain, the prevalence of TB in badgers has been reported to have been consistently higher in South-West England than elsewhere, with very few cases recorded from Scotland and the North and East of England (Cheeseman *et al.* 1989). However, as section 4.3 of this Report makes clear, unquantifiable biases in the sampling, and the sparseness of data in areas at lower risk of herd breakdown make it difficult to draw firm conclusions from the data.

3.3 Badger demography, population structure and behaviour

3.3.1 To understand the likely mode of TB transmission, the spatial distribution and temporal dynamics of the disease, and to design strategies for TB control, it is necessary to have a knowledge of badger biology. In this section, we review aspects of badger distribution, demography and behaviour relevant to the dynamics of TB in badger populations.

Numbers and distribution of badgers in Britain

3.3.2 Both extensive and intensive studies indicate that badgers are most abundant in the South and West of Great Britain (Figure 3.1). The highest density recorded is that in Woodchester Park, where there are more than 25 adult badgers/km² (Rogers *et al.* in press), while in Scotland there are typically only two to three adults and cubs/km² (Kruuk 1989).

3.3.3 It is difficult to estimate population density accurately for nocturnal animals, and extensive surveys have therefore counted main setts rather than badgers themselves (Cresswell *et al.* 1990). The accuracy of these surveys is likely to be limited, partly because they assume that each social group occupies a single main sett, and partly because they ignore local variations in group size. Each survey has counted the number of main setts in about 2,500 1km² squares across Britain (Cresswell *et al.* 1990; Wilson *et al.* 1997). By assigning each square to one of 32 land classes, these surveys have extrapolated the density of main setts in each land class, and used this to arrive at regional estimates of badger density. Despite their limitations, these surveys provide relative estimates of badger numbers at the regional level. Estimates of main sett density derived from data collected in the 1990s are higher than those for the 1980s, with significant differences for South-West England and the West Midlands (Table 3.1). Detailed studies in particular sites support the conclusion that population density has risen (see paragraph 3.3.7).

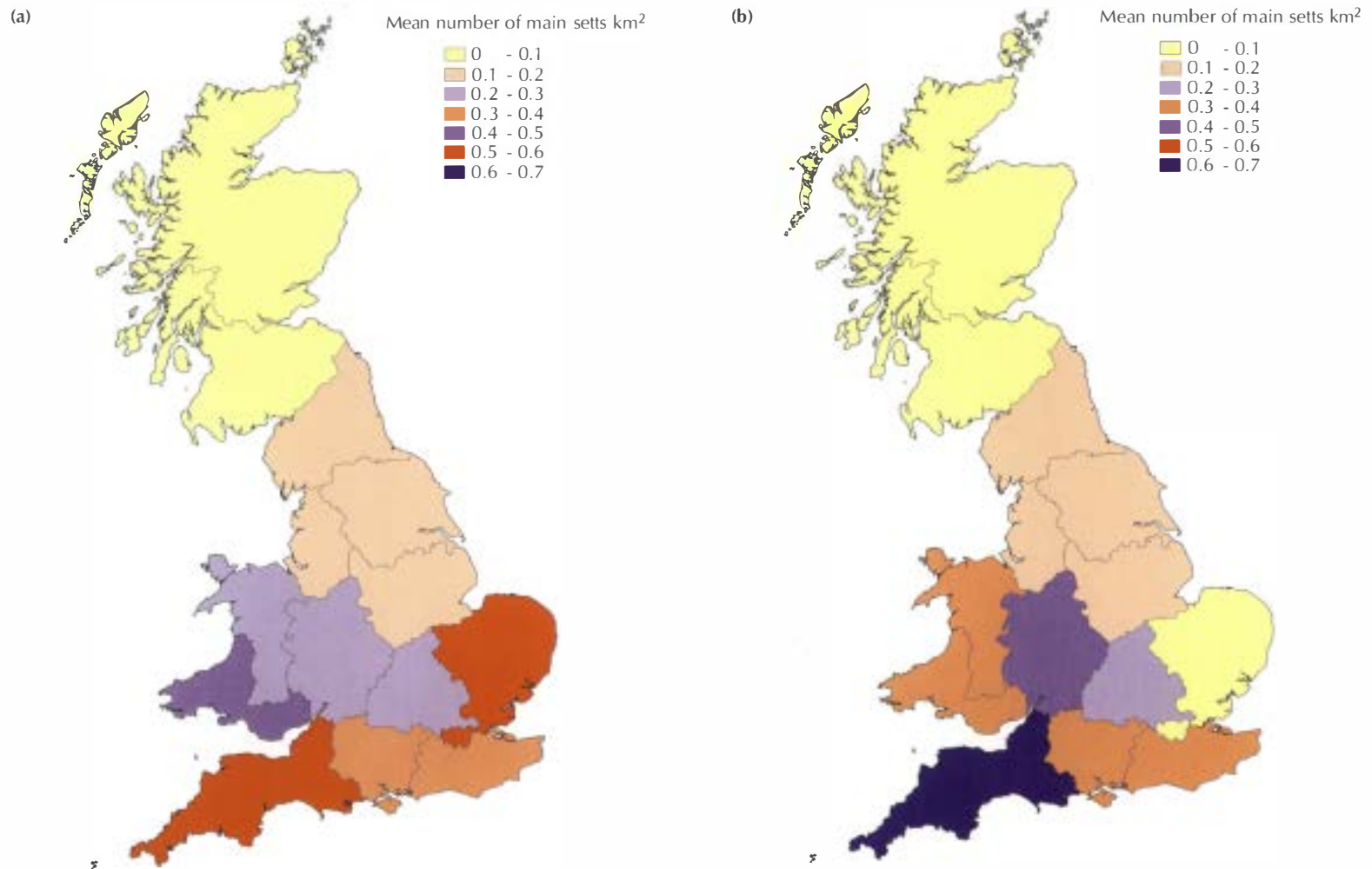

Figure 3.1 – The estimated density of badger social groups across Britain, extrapolated on the basis of land classes, in (a) the late 1980s, and (b) the mid-1990s.
 Source: Wilson G., Harris S. and McLaren G. (1997). Changes in the British badger population, 1988-1997. Copyright of the People's Trust for Endangered Species, London.

Region	Estimated number of main setts/km ²		Number of squares surveyed	% difference
	1980s	1990s		
North England	0.106	0.112	170	+6
North-west England	0.181	0.167	72	-8
North-east England	0.140	0.174	121	+24
West Midlands	0.249	0.463	177	+86 *
East Midlands	0.183	0.190	153	+4
Central England	0.242	0.286	91	+18
East Anglia	0.056	0.087	161	–
South-west England	0.566	0.698	205	+23 *
Southern England	0.351	0.374	131	+7
South-east England	0.340	0.390	159	+15
North Scotland	0.022	0.033	366	–
South Scotland	0.072	0.072	208	0
North and mid-Wales	0.238	0.322	143	+35
South Wales	0.412	0.404	114	-2

Table 3.1 – Estimated main sett densities in Britain for 1988-1997, based upon repeated surveys of 1km² squares, in studies commissioned by the Mammal Society and the People’s Trust for Endangered Species. Data taken from Wilson *et al.* (1997).

The number of squares surveyed indicates the number of 1km² squares re-surveyed in the two studies. Asterisks denote two regions where repeated surveys of the same squares generated statistically significant differences in estimated main sett density between the 1980s and the 1990s (Wilcoxon matched pairs test: West Midlands, $p < 0.001$, South-west England, $p < 0.01$). In none of the other regions is the difference statistically significant. Dashes in the final column indicate that sett densities were too low to give a meaningful estimate.

Studies of badger ecology in the British Isles

3.3.4 Our knowledge of badger behaviour, demography and population structure in the British Isles is based largely upon nine studies (see Table 3.2). More information has become available since the publication of the Dunnet report (Dunnet *et al.* 1986), but many of the data needed to answer critical questions about the dynamics of TB in badgers are still unavailable. This is a result of several factors.

- (i) Few populations under study have been screened for *M. bovis* infection.
- (ii) Only one (recent) study has been initiated in an area where badgers have been subjected to control (North Nibley).
- (iii) Most studies concern high density populations.
- (iv) Sample sizes are small, since study sites typically contain 10-20 study groups, and in all cases only a proportion of groups sustains *M. bovis* infection.
- (v) Badger behaviour and demography varies substantially between sites, making it difficult to generate predictions about the effects of proposed management strategies.

Study site	Study period	Study area	Study groups	Territory size (ha)	Group size		Population density	TB status	Comments	References
					Adults	Cubs				
Woodchester Park, Gloucestershire	1976-present	7.3km ²	32	35	1978:2.7 1993:8.8	1978:1.7 1993:3.7	1979: 10.3 adults/km ² 1993: 25.3 adults/km ²	confirmed	11 social groups were removed in 1978-9	1,2,3,4
Wytham Woods, Oxfordshire	1972-5, 1982-3, 1987-present	~6km ²	16	40	5.72	2.03	1974: 8.4 adults & cubs/km ² 1989: 16.7 adults/km ²	unknown		5,6
Suburban Bristol	1978-1985	~8km ²	15	51	2.61	1.25	5.7 adults/km ²	unknown	urban habitat	7,8
Speyside, Inverness-shire	1977-1986	12km ²	8	206	4.31	1.81	2.2 adults & cubs/km ²	unknown		9,10
New Deer, Aberdeenshire	1979	15km ²	2	159	9.5 (adults & cubs)		6.0 adults & cubs/km ²	unknown		9,10
Ardnish, Inverness-shire	1976-7	12km ²	2	173	3.5 (adults & cubs)		2.1 adults & cubs/km ²	unknown		9,10
South Downs, East Sussex	1983-1995	6.2km ²	15	41	?	?	13.5 adults/km ²	present in cattle		11,12
County Cork, Republic of Ireland	1987-present	~14km ²	10	?	3.5 (adults & cubs)		2.5-3 adults & cubs/km ²	confirmed	population density is low due to persecution	13,14
North Nibley, Gloucestershire	1995-present	~18km ²	22	~80	?	?	?	confirmed	study of perturbation following BROs	15,16

Table 3.2 – Studies of badgers carried out in the British Isles.

References: (1) Cheeseman *et al.* (1987); (2) Cheeseman *et al.* (1988b); (3) Cheeseman *et al.* (1993); (4) Rogers *et al.* (in press); (5) Kruuk (1978b); (6) Woodroffe (1992); (7) Harris and Cresswell (1987); (8) Cresswell and Harris (1988); (9) Kruuk and Parish (1982); (10) Kruuk (1989); (11) Roper *et al.* (1993); (12) Roper and Lips (1993); (13) Sleeman (1992); (14) Sleeman and Mulcahy (1993); (15) Tuytens and Macdonald (1995); (16) Tuytens and Macdonald (1997).

Population density

3.3.5 Badger density is determined by the availability of food and sett sites. Kruuk and Parish (1982) found that, across Scotland, badger population density correlated with the biomass of earthworms, badgers' principal prey (see below). In the Republic of Ireland, the density of badger social groups correlates with the availability of cattle pasture, badgers' preferred foraging habitat (Smal 1995). The distribution of sites suitable for sett construction may also limit badger numbers (Roper 1993). Setts are dug mainly in wooded areas and hedgerows, on well-drained sloping ground. Badgers are scarce in parts of Britain, such as the flat arable areas of East Anglia, where there are few suitable sett sites (Figure 3.1; Table 3.1).

3.3.6 It is unlikely that badger population density is limited by predators other than humans anywhere in their geographic range, or at any time in their recent history. Larger predators are known to be important in limiting the numbers of other carnivores (Polis and Holt 1992), but badgers are relatively immune to predation. Their teeth and jaws are unusually strong, and adults have been reported to survive attack from up to nine dogs in the course of illegal badger 'baiting' (Neal and Cheeseman 1996). Badgers' characteristic colour pattern is believed to be a form of warning coloration to deter predators (Ortolani and Caro 1996). The size, depth and complexity of badger setts means that cubs are also relatively safe from predation.

3.3.7 Intensive studies show that badger population density in England has increased over the past 20 years. In Woodchester Park, density rose from 7.8 adults per km² in 1978 to 25.3 adults per km² in 1993. In Wytham, density rose from 8.4 adults and cubs per km² in 1974 to 16.7 adults per km² in 1989 (Table 3.2). Both populations are still increasing.

3.3.8 The reasons for the increase in badger numbers are unknown, but probably include lower 'predation' by humans as a result of stricter badger protection legislation (paragraphs 1.5.3 to 1.5.6). Increased food availability due to changing agricultural practice may also be a factor: for example, at Wytham the conversion of arable land to pasture was associated with increased badger numbers (da Silva *et al.* 1993).

Feeding ecology

3.3.9 Badgers forage mostly at night, rarely leaving the sett before sunset, and returning before sunrise (Neal and Cheeseman 1996). They feed largely on invertebrates but also on fruit and cereals. Earthworms represent the greatest part of their diet (Kruuk 1989; Neal and Cheeseman 1996). Earthworms are most abundant under permanent pasture, where there may be over 1,000kg of worms per hectare (Kruuk 1978a). Badgers catch earthworms that come to the soil surface to feed at night. Their feeding success is highest on short-grass pasture, which they prefer to long grass (Kruuk *et al.* 1979). As a result, badgers tend to forage where cattle grazing is most intense.

Group size and composition

3.3.10 All badgers studied in Great Britain live in social groups of between two and 25 animals which share a territory and one or more setts. Across study sites, group size increases with the biomass of earthworms per territory (Kruuk and Parish 1982). Despite such broad trends, it is difficult to account for differences in the sizes of particular groups: there is no correlation between group size and territory size (Kruuk and Parish 1982), and the same territory may support between two and 21 badgers within a six-year period (Cheeseman *et al.* 1987).

Territorial behaviour and territory size

3.3.11 In undisturbed badger populations, each social group defends a territory containing one or more main setts, and a number of smaller setts which are used only

Study site	Density (adults/km ²)	Apparent adult mortality ^a (and 95% confidence intervals)			Apparent cub mortality ^a (and 95% confidence intervals)			Life Expectancy ^b	% females lactating		Per capita cub production ^c	Population growth rate ^d	Dispersal rate		References
		males	females	combined	males	females	combined		2 year olds	3+ year olds			males	females	
Woodchester	25.3	27.0%	20.6%	23.1%	33.9%	26.4%	30.2%	7.1 years	27.7%	52.7%	0.33 cubs	0.193	4.7%	0%	1,2,3
		23.0-33.6	17.1-24.7	20.5-28.4	30.2-45.9	21.1-31.6	26.2-38.3								
Wytham	16.7	24.0%	24.5%	24.3%	24.3%	43.6%	34.2%	5.7 years	20.8%	71.6%	0.33 cubs	0.094	6.6%	9.6%	4,5
		0.0-40.4	11.1-38.8	5.6-39.3	0.0-51.3	12.4-83.4	6.7-66.8								
Bristol	5.7	40.3%	28.1%	34.5%	40.8%	42.1%	41.4%	5.0 years	0%	56.4%	0.29 cubs	0.154	27.7%	11.3%	6,2
		24.7-54.2	18.9-38.2	30.4-38.4	19.3-60.5	22.7-59.4	23.4-58.1								
Speyside	2.2*	–	–	12-25%	–	–	–	–	combined	38.6%	–	–	26.1%	0%	7

Table 3.3 – Summary of demographic variables in the four best-studied British badger populations.

a Calculated as proportion of marked animals that disappear each year.

b This gives the mean life expectancy from first capture as a cub; it is calculated as the reciprocal of per capita mortality rates derived by fitting exponential decay curves to the survivorship data presented in Figure 3.2.

c Calculated as the proportion of the population that are weaned cubs – this is not a birth rate as it ignores pre-capture mortality.

d Calculated by subtracting per capita mortality (the reciprocal of life expectancy) from per capita cub production.

*This figure refers to adults and cubs together.

References: (1) Cheeseman *et al.* (1987); (2) Cheeseman *et al.* (1988); (3) Rogers *et al.* (in press); (4) Woodroffe and Macdonald (1995a); (5) Woodroffe and Macdonald (1995b); (6) Harris and Cresswell (1987); (7) Kruuk (1989).

sporadically. Territory size correlates with latitude within Britain: in southern England territories may be as small as 14 hectares, but they average 206 hectares in the Highlands of Scotland (Table 3.2, Woodroffe and Macdonald 1993). Territory borders are marked with latrines, where badgers deposit urine and faeces as well as secretions from various scent glands (Roper *et al.* 1993). Fights may take place on territory borders (Kruuk 1989), and badgers transgress them relatively rarely: badgers radio-tracked in Sussex typically spent more than 95% of their active time inside their own group territories (Roper and Lüps 1993).

Fertility

3.3.12 The timing of reproduction reflects seasonal variation in food availability. Cubs are born at the end of the winter (usually mid-February) and weaned in early summer (usually May), becoming independent around the time that food is most abundant. Females may conceive again soon after giving birth, but the fertilised eggs do not immediately implant in the walls of the uterus (Canivenc and Bonnin 1981). Instead, they stop growing at an early stage of development and remain free in the uterine horns until they implant the following winter. As a result, conception may occur at any time between February and November, even though all of the cubs are born at roughly the same time (Cresswell *et al.* 1992; Neal and Harrison 1958).

3.3.13 The majority of sexually mature females conceive, but the proportion of females that successfully produce cubs is considerably lower (Table 3.3). This discrepancy has been attributed to failure of implantation (Cresswell *et al.* 1992; Page *et al.* 1994), and to high mortality of new-born cubs (Wandeler and Graf 1982). The only study to monitor pregnancy in live females (by ultrasound scanning) found that implantation occurred in 79% of adult females, including all females aged three years or more, but that only 58% produced cubs (Woodroffe and Macdonald 1995b).

3.3.14 The number of females that breed in a social group appears to reflect local food availability. Fewer females breed in each group at higher latitudes: in Scotland only one female typically breeds per group, while in southern England as many as five females may raise cubs successfully (Woodroffe and Macdonald 1995b). Within the Wytham population, more females breed in territories containing large areas of pasture (da Silva *et al.* 1993). A higher proportion of females raise cubs in small social groups than in larger ones, indicating that female reproductive success is dependent upon local population density (Woodroffe and Macdonald 1995b).

Mortality of weaned cubs

3.3.15 Approximately 35% of weaned cubs die during their first year of life (Figure 3.2, Table 3.3), but survival varies between years. For example, in Wytham cub mortality ranged from 12% to 74% over a six-year period (Woodroffe 1992) and was lowest following wet summers, and in small groups occupying territories containing

relatively large areas of permanent pasture (Woodroffe 1992). The effect of adult group size indicates that, like female breeding status, cub mortality is partly dependent upon local population density.

Adult mortality

3.3.16 Death is often difficult to distinguish from emigration in badgers, since carcasses are rarely found. Nevertheless, the rate at which animals disappear from a population gives an approximation of the mortality rate. Estimates of mortality rates are available for four study populations (Table 3.3), and survivorship curves can be constructed for three (Figure 3.2).

3.3.17 Between populations, annual adult mortality varies from 23.1% in Woodchester to 34.5% in Bristol (Table 3.3). Inter-annual variation in adult mortality is lower than that for cubs (e.g. 30% to 38% for adults in Bristol, compared with 20% to 65% for cubs over the same period (Harris and Cresswell 1987)).

Rates of population recovery

3.3.18 Birth and death rates can be used to make rough predictions about the time badger populations will take to recover from perturbations such as badger removal operations (Anderson and Trehwella 1985). Recovery time is calculated as the reciprocal of the population's intrinsic growth rate (May 1973). Estimates of population growth rates are given in Table 3.3. Using these data, recovery times are estimated as 5.2 years for Woodchester, 6.5 years for Wytham, and 10.6 years for Bristol. These estimates compare well with the finding that population density within the Woodchester removal area returned to its pre-removal level after ten years of no culling (Cheeseman *et al.* 1993). Recovery times are greater for larger-scale removals: in the 104km² removal area at Thornbury, about half of the setts remained unoccupied 11 years after the cessation of badger control (Clifton-Hadley *et al.* 1995b).

Immigration and emigration

3.3.19 Very few badgers leave the social groups into which they are born. In Wytham, 82% of males and 78% of females that survived to sexual maturity were still in their natal groups by the age of four years (Woodroffe *et al.* 1995). Badgers that leave their natal territories typically join neighbouring groups, and seldom move more than 1 to 2km (Cheeseman *et al.* 1988a; Woodroffe *et al.* 1995).

3.3.20 Across populations, the rate of male dispersal declines as population density increases, but there is no such relationship for females (Woodroffe *et al.* 1995). Females are less likely than males to change groups in Woodchester, Bristol and Speyside but, in Wytham, females disperse at a higher rate, and over longer distances, than do males (Cheeseman *et al.* 1988a; Kruuk and Parish 1987; Woodroffe *et al.* 1995). There, dispersing females move in coalitions of two or three related animals, and may oust resident females from all or part of their territories (Woodroffe *et al.* 1995). New

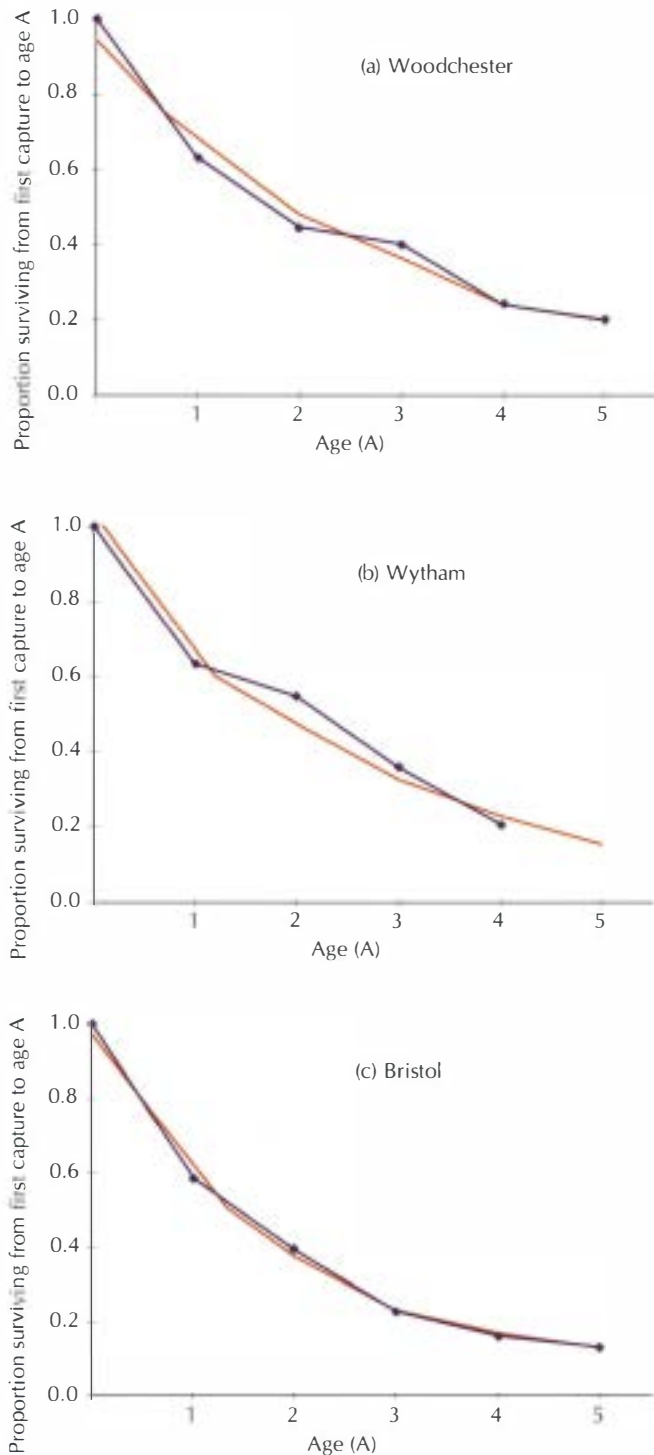

Figure 3.2 – Survivorship curves following first capture as a cub for badgers in (a) Woodchester, (b) Wytham, (c) Bristol.

Smooth curves are exponential decay curves fitted to the data to allow estimation of per capita annual mortality rates which are: Woodchester – 0.141; Wytham – 0.174; Bristol – 0.199.

Sources: Woodchester data – Cheeseman *et al.* (1987); Wytham data – Woodroffe (unpublished); Bristol data – Harris and Cresswell (1987).

analyses suggest that dispersal coalitions also occur in Woodchester (L.M. Rogers and C.L. Cheeseman, personal communication).

3.3.21 Both males and females also make temporary movements between territories. In Woodchester, Bristol, Sussex and Wytham badgers of both sexes were occasionally captured or located by radio-telemetry in the territories of neighbouring social groups (Cheeseman *et al.* 1988a; Roper and Lüps 1993; Woodroffe *et al.* 1995). In County Cork, where population density has been depressed by persecution, badgers have been radio-tracked on excursions that took them as far as 7.5km from their home setts (Sleeman 1992). The reasons for such extra-territorial forays are not always clear, but circumstantial evidence suggests that many are attempts to mate with members of other social groups (Woodroffe *et al.* 1995). In both Wytham and Woodchester a proportion of cubs are sired by males from outside the social group in which they are born (da Silva *et al.* 1994; Evans *et al.* 1989).

3.4 TB within badger populations

Pathogenesis of TB in badgers

3.4.1 As in other species, TB is not necessarily or immediately fatal for badgers (Gallagher *et al.* unpublished data; Morris *et al.* 1994). While in some animals disease takes a rapid course, survival for up to 709 days has been recorded in Woodchester (Clifton-Hadley *et al.* 1993), and a captive badger survived for 3½ years while excreting *M. bovis* (Little *et al.* 1982). In Woodchester, of 47 tuberculous badgers that died, only 19 actually died of TB (Clifton-Hadley *et al.* 1993), and TB accounts for just 7% of total recorded badger mortality (Figure 3.3, Rogers *et al.* in press).

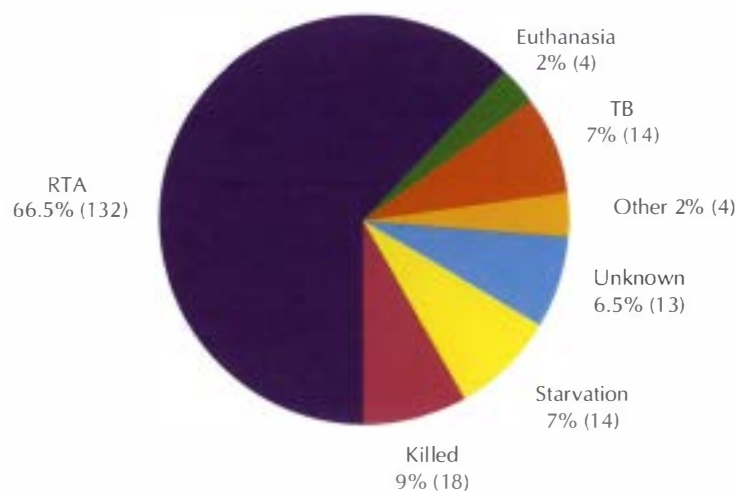

Figure 3.3 – Causes of death in badgers from 21 social groups in Woodchester Park from 1978 to 1993. Source: Rogers *et al.* (in press). Copyright of the Zoological Society of London.

3.4.2 It is likely that most tuberculous badgers become infected via the respiratory route, since the majority of lesions occur in the lungs or associated lymph nodes (Clifton-Hadley *et al.* 1993; Nolan and Wilesmith 1994). In a small proportion of cases there is widespread involvement of the lungs and in many of these animals infection enters the circulatory system and spreads to other organs (haematogenous spread). In such cases the kidneys are commonly affected (Nolan and Wilesmith 1994).

3.4.3 Badgers may also acquire *M. bovis* infection via bite wounds. *M. bovis* can be cultured from swabs taken from the teeth of infected animals (J. Gallagher, personal communication). Five of 47 badgers in which tuberculous lesions were detected at post-mortem showed evidence of having become infected through bite wounds (Clifton-Hadley *et al.* 1993). Haematogenous spread from bite wound infections may cause lesions in other organs. Such infections appear to be more severe than those acquired via the respiratory route: on average badgers infected via bite wounds survived 117 days (95% confidence limits: 0 and 276) after first diagnosis, compared with 491 days (95% confidence limits: 309 and 673) for badgers infected by other routes (Clifton-Hadley *et al.* 1993).

3.4.4 There is evidence that cubs develop lesions more readily than do adults, but the lesions are less severe (Nolan and Wilesmith 1994). Serological data suggest that cubs may be exposed to *M. bovis* early in life: 10 out of 16 culture-negative badgers in a single group at Woodchester were briefly seropositive as cubs, suggesting that they might have acquired immunity to TB (Newell *et al.* 1997).

3.4.5 Up to 85% of badger carcasses shown by culture to be infected with *M. bovis* have no visible lesions at post-mortem: more detailed study, however, has shown that the majority of these have very small (less than 1 mm diameter) lung lesions (Gallagher *et al.* unpublished data). Many of these lesions appear to have healed and contain few or no bacteria. These findings indicate that badgers can acquire latent infection, which may resolve or be reactivated in later life. They also suggest that additional animals with latent infection might be present among those that are culture-negative on post-mortem examination.

3.4.6 Animals with extensive lesions in the lungs and kidneys shed large numbers of *M. bovis* in the sputum and urine (up to 300,000 organisms/ml urine (MAFF 1979)), while those with focal lung lesions excrete smaller numbers of organisms more intermittently. *M. bovis* is also present in the faeces of heavily infected animals, as a result of swallowing sputum, although the concentration is much lower than in sputum or urine (MAFF 1979). In Woodchester, where infection is detected in around 3% of badgers, culture of samples obtained from 7,157 badger captures over a 21-year period detected excretion of *M. bovis* from the respiratory tract on 97 occasions (1.5%), and in urine on 37 occasions (0.5%). *M. bovis* can also be shed in large numbers (up to 200,000 organisms/ml (MAFF 1979)) in pus from infected bite wounds.

Characteristics of infected and uninfected badgers

3.4.7 There is no evidence to suggest that *M. bovis* infection is especially prevalent in any particular age-sex class: there are no statistically significant differences in prevalence between males and females, adults or cubs (see Table 3.4).

Site	Year	Density (adults/km ²)	Prevalence of <i>M. bovis</i> infection detected at post-mortem (sample size)						Total	Groups	References
			Adults		Cubs						
			males	females	males	females					
Gloucestershire I	1978	19.7	6.7% (15)	9.1% (11)	0% (2)	0% (1)	6.9% (29)	33.3% (6)	1		
Cornwall	1978	4.7	38.5% (13)	28.6% (7)	20% (5)	50% (4)	34.5% (29)	33.3% (6)	1		
Avon	1979	4.9	11.1% (9)	6.3% (16)	30.8% (13)	100% (2)	20% (40)	42.9% (7)	1		
Gloucestershire II	1979	19.4	20% (10)	31.6% (19)	20% (5)	75% (4)	31.6% (38)	80% (5)	1		
Staffordshire	1982	6.2	18.8% (16)	25% (16)	0% (4)	11.1% (9)	17.8% (45)	60% (5)	2		
Total	–	–	19.0% (63)	20.3% (69)	20.7% (29)	40% (20)	22.1% (181)	48.3% (29)			

Table 3.4 – Prevalence of *M. bovis* infection in badger individuals and social groups killed in the course of badger removal operations.
Sources: (1) Cheeseman *et al.* (1981); (2) Cheeseman *et al.* (1985).

Relationship between infection and badger density

3.4.8 Data are not available at the appropriate spatial scale to determine whether TB is more prevalent in high-density badger populations. In Woodchester, *M. bovis* infection is no more common in large or small groups, and changes in TB prevalence do not reflect variation in group size (Cheeseman *et al.* 1988b). However, the small sample size provides low statistical power for the detection of effects. The recent increase in badger density in areas where TB is endemic means that the number, and possibly the proportion, of infected badgers has probably risen in these areas, increasing the likelihood of transmission to cattle.

Distribution across groups

3.4.9 Infections of *M. bovis* are usually highly localised within badger populations. In every population which has been studied, some social groups show no sign of infection with *M. bovis*, even though their territories abut those of infected groups (Figure 3.4, Cheeseman *et al.* 1981; Cheeseman *et al.* 1985; Cheeseman *et al.* 1988b). Data from five badger removal operations are summarised in Table 3.4, all carried out before the introduction of the clean ring strategy. Of the 29 complete social groups removed, only 14 (48.3%) contained badgers shown by culture to be infected with *M. bovis* on post-mortem examination. At the site in Cornwall, the territory of a group in which all members were found to be infected shared borders with those of four other groups, three of which contained no infected badgers (Cheeseman *et al.* 1981).

3.4.10 Studies at Woodchester Park show a similar pattern. A relatively small proportion of the undisturbed groups under study have sustained infection over several years

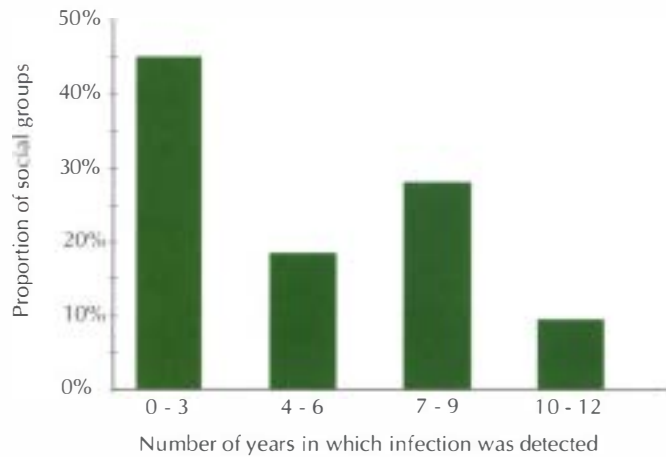

Figure 3.4 – The frequency with which *M. bovis* infection has been identified (by ELISA or culture) over the period 1981 to 1995 in 22 undisturbed social groups of badgers at Woodchester Park.

Source: C.L. Cheeseman, personal communication.

(Figure 3.4), and all of these occupy territories in the south-west corner of the study site (Figure 3.5). Sporadic infection has occurred in the other groups, but only once has persistent infection become established in a new territory in the course of the study. The intermittent infection noted at Woodchester Park could result from infection dying out and then being reintroduced by spread between social groups. An alternative explanation is that infection is continually present, but not always detectable given the limitations of the methods used to detect infection, particularly in live animals (see paragraphs 6.3.24 to 6.3.26). Whatever the explanation, the sum of available evidence indicates that infection with *M. bovis* remains highly localised in undisturbed badger populations.

TB transmission within badger groups

3.4.11 The concentration of *M. bovis* infection within particular territories provides circumstantial evidence that most transmission occurs between members of the same social group, rather than between different groups. There are, however, rather few data on the mechanisms of transmission between badgers. Most badgers acquire *M. bovis* infection via the respiratory tract (see above). Transmission probably occurs mainly within the sett, which provides ideal conditions for the spread of infection. Badgers' habit of sleeping together in the same chamber (Roper and Christian 1992) could provide protracted and repeated contact between infectious and susceptible group members. Transmission from mothers to cubs is especially likely, and might represent an important route for *M. bovis* transmission.

3.4.12 Badgers also acquire infection by bite-wounding. However, patterns of aggression are poorly understood, and the role of bite-wounding in transmission within social groups is unclear.

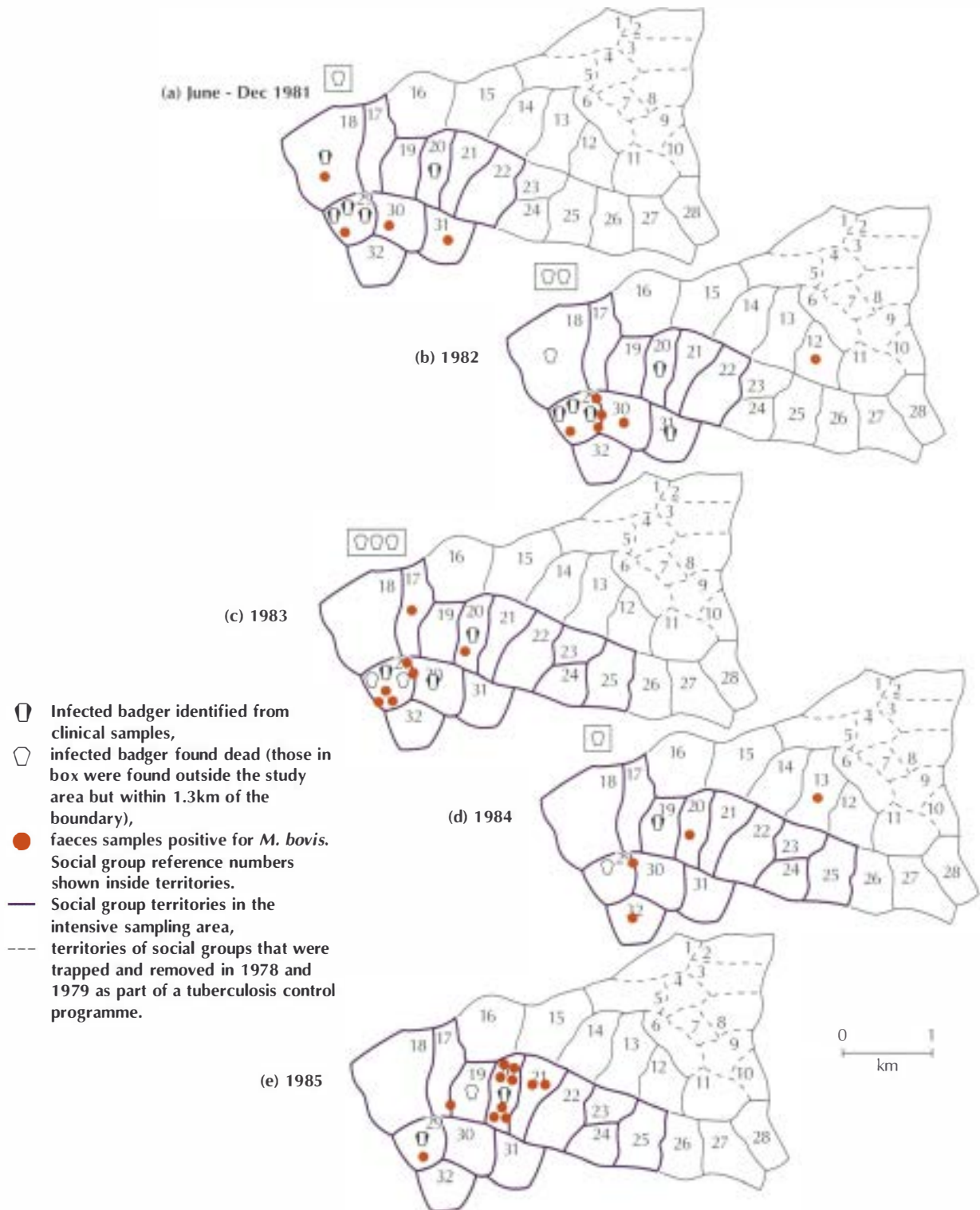

Figure 3.5 – Maps of badger territories in the Woodchester study site, showing where evidence of *M. bovis* infection was found over a five-year period.

Source: Cheeseman *et al.* (1988b). Copyright of Blackwell Scientific Ltd, Oxford.

3.4.13 Setts themselves may harbour infection with *M. bovis* for short periods. The environmental conditions inside badger setts (100% humidity, constant temperature and complete darkness (Roper 1992)) are likely to allow survival of the bacterium. However, only limited data are available on this. Setts appear not to remain infectious for more than a few weeks. Experimental studies that kept naturally infected faeces in a disused badger sett found that *M. bovis* could be recovered after one week, but not after one month (MAFF 1979). Excavation of setts known to have been inhabited by infected badgers found that *M. bovis* could be recovered seven days after badger removal (one sett), but not after three to six months (three setts (MAFF 1979)). Following removals at Woodchester Park a few immigrant badgers occupied the vacated setts within days (C.L. Cheeseman, personal communication), but the first cases of TB in badgers were not recorded until ten years later (Cheeseman *et al.* 1993). This suggests that infection from the sett was not involved in the re-establishment of infection in this part of Woodchester.

TB transmission between badger groups

3.4.14 Transmission between social groups appears to occur infrequently in undisturbed badger populations. In theory, inter-group transmission could occur in a number of ways. First, temporary forays across territory borders could provide an opportunity for transmission between members of neighbouring social groups, either by inhalation or bite-wounding. Alternatively, TB might be carried between social groups by dispersing animals. Differences in immigration and emigration behaviour between populations may therefore have implications for the transmission of *M. bovis*.

3.4.15 If mother-to-cub transmission represents a principal route of infection, movement of breeding females between groups could be crucial to the establishment of infection in a new territory.

3.4.16 Finally, 'nomadic' badgers, which wander over relatively large areas, using several setts and the home ranges of several groups, could also be important in the transmission of TB between groups. Cheeseman *et al.* (1988a) recorded four cases of such 'nomadic' behaviour in animals severely debilitated during the final stages of clinical TB. At least one of these animals had been bitten repeatedly, and appeared to have acquired infection via a bite wound (Cheeseman and Mallinson 1981).

3.5 What conditions are likely to facilitate TB transmission from badgers to cattle?

3.5.1 Although there is strong circumstantial evidence that TB is transmitted from badgers to cattle (see Chapter 2), the exact route of transmission remains uncertain. Nevertheless, informed predictions can be made about the circumstances likely to facilitate badger to cattle transmission. Direct contact between cattle and live badgers is uncommon. Since most cattle apparently become infected via the respiratory route (paragraph 6.2.1), inhalation or ingestion of bacteria from badger urine, faeces, sputum

or pus deposited in their shared environment represents the most likely route of transmission. The probability of transmission will be determined by how many bacteria are shed into the environment, how long they survive, and whether cattle are likely to come into contact with them.

Numbers of bacteria excreted into the environment

3.5.2 Cattle will be more likely to contact *M. bovis* if more bacteria are present in the environment. Thus, the incidence of TB in cattle is likely to be high where the density of infected badgers is high, either because badger density is high, or because TB prevalence is high. The rate of excretion of bacteria also varies between badgers, and over time in the same badger (see above). The pathogenesis of TB may be partly stress-related in badgers, and it is possible that stress influences excretion of *M. bovis* (Gallagher *et al.*, unpublished data). Woodroffe and Macdonald (1995a) found evidence that, among males, dominant breeding status leads to depressed white blood cell counts. Thus behavioural and ecological stressors such as breeding status, lactation, or low food availability due to dry weather or high badger population density, might all in turn affect the exposure of cattle to *M. bovis* (Gallagher *et al.*, unpublished data).

Survival of bacteria in the shared environment

3.5.3 *M. bovis* is a relatively resistant bacterium. Survival times vary considerably, but are longest at high relative humidities and under dark conditions. Suspension in badger urine appears to increase the resistance of the bacterium to ultra-violet radiation (E. King, unpublished data). *M. bovis* survived for three days on pasture in summer and 28 days in winter when suspended in badger urine, for seven and 70 days respectively in bronchial pus, and for 14 and 28 days in faeces (MAFF 1979). Thus, weather conditions probably affect the exposure of cattle to viable bacteria on pasture, although there are no detailed data concerning the extent to which this varies. Survival would probably be longer in shaded conditions inside farm buildings and badger setts.

How and where might cattle contact bacteria?

3.5.4 The probability of cattle contacting *M. bovis* bacteria excreted by badgers depends upon the behaviour of both species. Badgers in the final stages of TB appear to enter farm buildings more often than do uninfected badgers (Cheeseman and Mallinson 1981). Such behaviour has not been thoroughly investigated, but the high rate of *M. bovis* excretion by such animals, and their close contact with cattle, may increase the likelihood of TB transmission.

3.5.5 Cattle may contact badger excreta elsewhere in their shared environment. Badgers are known to use water and feed troughs set out for cattle, and to visit mineral licks (C.L. Cheeseman, personal communication). However, the major route of transmission is likely to involve cattle inhaling or ingesting bacteria excreted by badgers directly onto pasture. Most cattle refuse to eat grass treated with badger excreta, but they will spend

relatively long periods investigating it (Benham and Broom 1991). Given that inhalation represents a major route of infection for cattle, and since cattle smell by first exhaling strongly, thus creating an aerosol, it has been suggested that simply investigating infected badger excreta might be sufficient to lead to inhalation of the bacteria.

3.5.6 Cattle prefer to graze field edges, which are also favoured scent-marking sites for badgers and likely to be contaminated with urine and faeces (Hutchings and Harris 1997; White *et al.* 1993). They become more willing to graze contaminated pasture when swards are short and grazing pressure is high (Benham and Broom 1991; Hutchings and Harris 1997). Short swards are also ideal foraging habitat for badgers (see above), so that contamination with badger excreta may be greatest in the environment where cattle are also least likely to avoid them.

3.5.7 Badger scent-marking behaviour varies with population density (see below): a greater proportion of urine and faeces are deposited away from latrines in low-density populations. As a result the contact rate between cattle and badger excreta may not be substantially lower in areas where badger population density has been reduced (M.R. Hutchings and S. Harris, unpublished data).

3.6 Effects of badger management strategies upon badger populations and behaviour

3.6.1 Since 1973, MAFF has adopted a number of strategies to attempt to reduce the transmission of *M. bovis* from badgers to cattle (see section 1.4). All of the strategies have involved some form of culling, and all have been criticised, to varying degrees, for being ineffective or inhumane. Chapter 5 deals with the effects of these culling strategies on TB in cattle and badgers. In this section we speculate on the likely general effects of these strategies upon badger populations.

Large scale effects on badger numbers

3.6.2 None of MAFF's badger control operations has represented a serious threat to overall badger numbers. For example, the mortality caused by badger removal operations is substantially lower than that caused by road accidents. The seven counties of the South-West Region contain an estimated 80,000 badgers, and natural mortality is 25% to 35% (Table 3.3); thus around 20-28,000 badgers probably die each year in this region. In 1986-9, MAFF killed an average of 732 (range 713-751) badgers per year in South-West England, while the carcasses of 1,044 (range 1,022-1,054) badgers killed in road accidents were submitted annually by the public in the same area.

3.6.3 When badgers have been systematically removed from relatively large areas such as Thornbury (about 104km²), recolonisation has begun as soon as control was halted, although it can take many years for the populations to recover fully (see paragraph 3.3.18). Smaller-scale badger removal operations carried out under the gassing, clean ring and

interim strategies can be expected to have proportionally smaller effects upon overall badger numbers.

Concerns about badger welfare

3.6.4 Gassing of setts with hydrogen cyanide was halted in 1982 after studies by the Chemical Defence Establishment reached the conclusion that this was inhumane. Thereafter, badgers were captured in cage traps and shot. It is unlikely that cage trapping involves serious stress or suffering, since badgers usually remain calm inside traps. Animals trapped and released by researchers will often enter traps again on the same or subsequent days, suggesting that any stress imposed by capture is not great enough to make badgers choose to avoid traps.

3.6.5 Cubs that have not yet emerged above ground cannot be caught by live-trapping. Both the clean ring and interim strategies therefore released lactating females to avoid leaving young cubs to die in the sett. If mother to cub transmission is an important part of TB dynamics, this strategy might seriously compromise attempts to control TB in the badger population, leading to the need to cull still more badgers. We consider, therefore, that in the interests of both badgers and cattle, it would be desirable to treat lactating females in the same way as other categories of badgers.

Effects on dispersal behaviour

3.6.6 Removing badgers from an established population is likely to affect the behaviour of the remaining animals, and these changes may influence the transmission of *M. bovis* between badgers or from badgers to cattle. In undisturbed populations, the rate at which male badgers disperse between social groups is highest at low density (Woodroffe *et al.* 1995). Reducing population density through badger control may therefore lead to more frequent dispersal, increasing the rate at which *M. bovis* is transmitted between groups. Such perturbation might have an important effect upon the spatial dynamics of *M. bovis* infection, and upon strategies for TB control (Swinton *et al.* 1997). However, the effects of perturbation on TB transmission have not been quantified. The study initiated at North Nibley (Table 3.2) may help to measure these effects in the future.

3.6.7 The effect of badger removal on transmission is likely to be greatest when social groups are disrupted rather than removed entirely. Studies of dispersal behaviour (see above) suggest that if a badger removal operation reduced a group to members of a single sex, for example, the remaining animals might leave the territory, or others might move in from elsewhere to re-form a breeding group. Movement of animals between territories, and the resultant fighting over breeding positions, are both likely to increase the transmission of *M. bovis* between members of different social groups.

3.6.8 Total removal of several social groups seems to have little effect upon the behaviour of badgers in neighbouring territories. Only a few animals moved into the part of the Woodchester study site that had been completely cleared of badgers, and the

population was re-established through the breeding of these founders (Cheeseman *et al.* 1993). Thus, perturbation is likely to be less important when badger removal operations have a high trapping success, and are carried out over larger areas.

Effects on territorial behaviour

3.6.9 Territoriality breaks down in badger populations that are highly disturbed. Badgers recolonising cleared areas do not initially defend territories: in the removal area at Woodchester, two radio-collared animals had large ranges and used setts that had belonged to several different social groups prior to the badger removal operations (Cheeseman *et al.* 1993). No division of the area into territories could be discerned in the first few years after the removal, but as population density rose, territories were re-established (Cheeseman *et al.* 1993).

3.6.10 A similar pattern emerges from a study of badgers in County Cork (Sleeman and Mulcahy 1993). This population was severely depressed by persecution, and the study area contained several main setts which were unoccupied. Large social groups defended well-defined territories, but smaller groups' ranges were more unstable and sometimes overlapped considerably (Sleeman 1992; Sleeman and Mulcahy 1993). Territory borders were also poorly-defined in the rather unstable badger population in suburban Bristol (Cresswell and Harris 1988).

3.6.11 Localised disruption of badger populations can lead to small-scale changes in territorial behaviour. Loss of all male members of a single social group in the Sussex study site led to the disruption of territorial borders of three contiguous territories (Roper and Lüps 1993).

Effects on scent-marking behaviour

3.6.12 The scent-marking behaviour of badgers in populations depressed by badger removal differs from that in undisturbed populations. Badgers in undisturbed populations tend to defaecate and urinate mostly in latrines. However, where density is low, most faeces and urine are deposited on pasture away from latrines: at Thornbury 96% of urinations and 84% of defaecations were away from latrines, compared with 38% and 0% respectively at Woodchester Park (M.R. Hutchings and S. Harris, unpublished data). This difference could increase the contact between cattle and badger excreta, making it more likely that an infected badger might transmit *M. bovis* to cattle using the same pasture.

3.7 Conclusions

3.7.1 Badger density appears to have increased in parts of Britain in the past ten years. Both badger density, and the prevalence of *M. bovis* infection in badgers, are highest in South-West England. In Woodchester Park, at least, TB prevalence has remained roughly constant as population density has increased. Thus, the number, and

possibly the proportion, of badgers infected with *M. bovis* in Britain has probably risen over the past decade (paragraphs 3.3.2, 3.3.3, 3.3.5 to 3.3.8 and 3.4.8).

3.7.2 TB infection can be highly localised within infected badger populations. Transmission seems to occur more frequently within, rather than between, social groups. Uninfected social groups can occupy territories adjoining those of groups with high TB prevalence (paragraphs 3.4.9 to 3.4.16).

3.7.3 Transmission of *M. bovis* from badgers to cattle would be most likely to occur when infected badgers deposit sputum, urine, faeces or pus containing bacteria into the environment which they share with cattle. Depending on weather conditions, bacteria may survive for days or weeks on pasture. Badgers prefer to forage on short-grass pasture, where cattle are also less likely to avoid grass contaminated by badger urine and faeces (section 3.5).

3.7.4 Badger removal operations are not a threat to overall badger numbers. Over the last decade badger removal operations have killed substantially fewer badgers within Britain than road accidents, and estimates of badger density in South-West England are now higher than in the 1980s despite badger control by MAFF. Local badger populations are likely to recover from small-scale badger removals within five to ten years, with slower recoveries for more extensive removals (paragraphs 3.3.18, 3.6.2 and 3.6.3).

3.7.5 Small-scale badger removals, such as those carried out under the interim strategy, may not substantially reduce contact between cattle and infected badgers because partial removal of social groups causes disruptions in territorial and dispersal behaviour. Altered territorial behaviour may increase the risk of transmission to cattle, since urine and faeces are deposited directly onto pasture rather than being concentrated in latrines on territory borders. Furthermore, changes in dispersal behaviour might lead to spread of the disease among the remaining badgers (paragraphs 3.6.6 to 3.6.12).

3.7.6 It is in the interests of both badgers and cattle for any culling strategy that aims to remove infected badgers to treat lactating females in the same way as other categories of badgers (paragraph 3.6.5).

4 Spatial and temporal trends in *Mycobacterium bovis* infection in cattle and badgers

4.1 Introduction

4.1.1 This chapter assesses the data on spatial and temporal patterns of *M. bovis* infection in cattle herds and between badger populations in England and Wales. In section 4.2, spatiotemporal patterns of herd breakdowns are described for the period 1987 to the present. In section 4.3, the pattern of *M. bovis* infection in badgers is described for the period 1972 onwards using the results of badger post-mortems conducted by MAFF. Section 4.4 describes molecular typing and assesses data on molecular types or 'strains' of *M. bovis* sampled from badgers, cattle and other wildlife. Section 4.5 reviews mathematical modelling and its use in understanding the epidemiology of the disease. Section 4.6 discusses various factors that may underlie patterns of *M. bovis* infection. Finally section 4.7 summarises conclusions and recommendations.

4.2 Spatial and temporal patterns of herd breakdowns

4.2.1 Appendix 2 sets out the proportion of total herds with reactors (i.e. both confirmed^a and unconfirmed^b breakdowns) for South-West England and the rest of England and Wales for the period 1962 to 1996^c (see also Figure 1.1). The number of herd breakdowns has increased since 1986, particularly in South-West England and Wales. Figure 4.1(a) plots new confirmed breakdowns in Great Britain from 1987 to 1991 and Figure 4.1(b) plots them for the period 1992 to 1996. Confirmed breakdowns are more numerous and more strongly clustered in Wales and South-West England than elsewhere. More detailed analysis suggests that within these areas there is considerable variation in breakdown rates and clustering but that, generally, clustering is stronger in areas of high herd breakdown rates.

4.2.2 Most herds in Great Britain (over 99% in each year) did not suffer from TB in the period 1987 to 1996. Of those that did, the majority, 85%, had only one breakdown (this figure was 90.2% for the period 1987 to 1991 and fell to 83.5% for the period 1992 to 1996). As Figure 4.2 shows, multiple (two or more) breakdowns are usually found within the clusters of herd breakdowns, which are also the areas where badger removal operations have taken place. Repeated breakdowns were even rarer during the gassing and clean ring strategies (see paragraphs 5.4.11 and 5.4.12 and Table 5.4).

4.2.3 Most of the increases in herd breakdown rates since 1987 have been in the clusters referred to above. Figures 4.1 (a) and (b) show how new breakdowns in the mid-1990s tended to be found in areas where there had been breakdowns in the mid-1980s. This means that historic data on breakdowns are good indicators of future risk.

^a A confirmed breakdown is one where the disease has been confirmed in one or more reactor animals at post-mortem or through laboratory culture.

^b Unconfirmed breakdowns are ones where post-mortem or culture does not confirm the disease in the reactors.

^c Details of confirmed herd breakdowns were not available for this period. Nor were comparable data available for Scotland.

Figure 4.1 – New confirmed herd breakdowns

(a) 1987 to 1991 (inclusive)

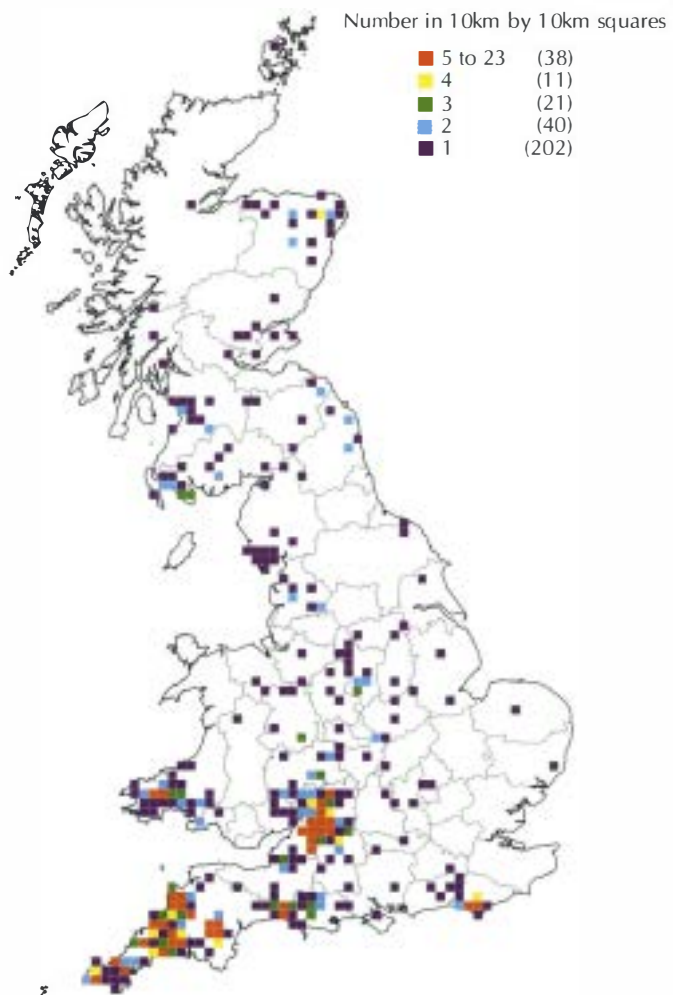

(b) 1992 to 1996 (inclusive)

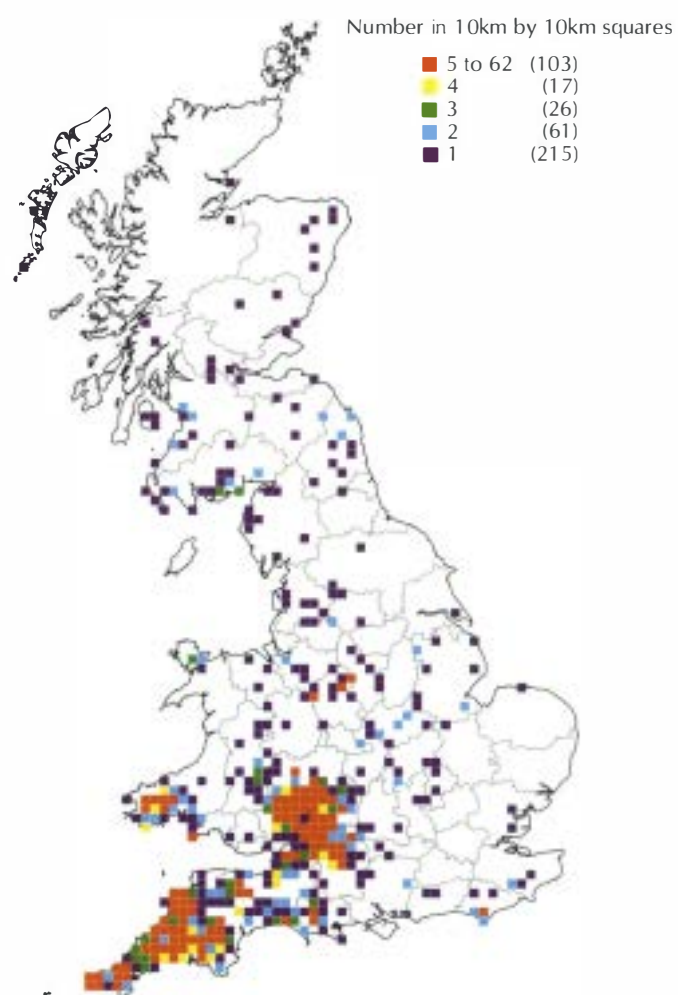
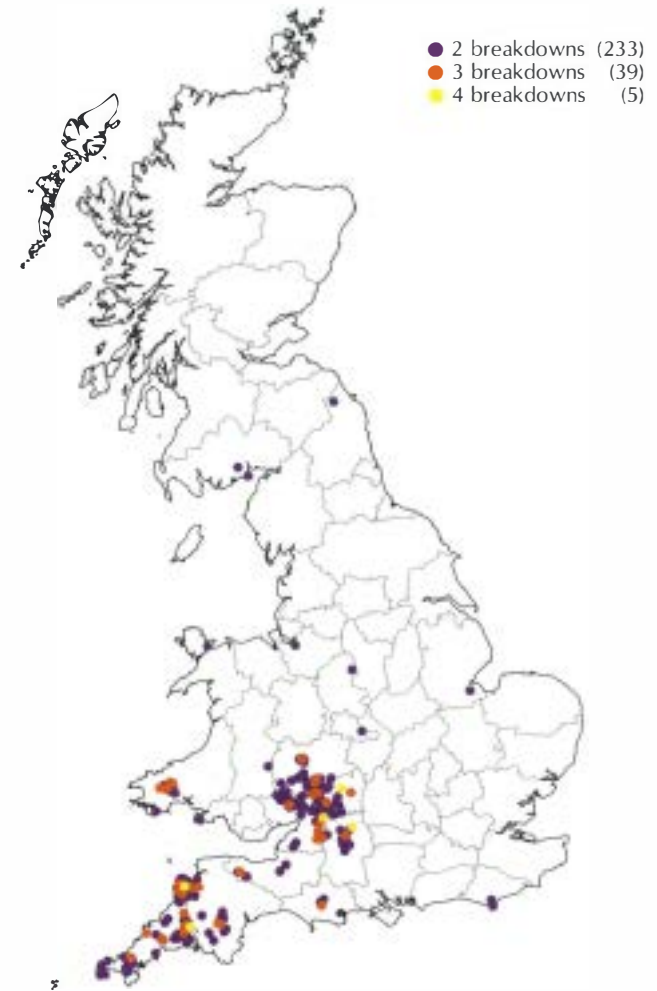

Figure 4.2 – Herds with more than one breakdown

(a) 1987 to 1991 (inclusive)



(b) 1992 to 1996 (inclusive)



However, breakdowns are also increasing in areas with no recent history of cattle TB. These areas cannot be identified by analysis of historical data. For example, in West Staffordshire there is a recent, loose cluster, and there is a large cluster which has expanded north from Avon and Wiltshire, through Gloucestershire, to Hereford and Worcester over the last ten years.

4.2.4 Both confirmed and unconfirmed breakdowns have increased since 1987 and the two are spatially and temporally correlated (see Appendix 6 and Figures 4.1(a) and (b)). The data on the number of reactors involved in breakdowns over the period proved too unreliable to enable any conclusive analysis on trends in large and small breakdowns in the time available.

4.2.5 The breakdown data referred to so far in this section refer to all breakdowns, whether attributed to badgers or other causes. The attribution of the cause of herd breakdown by MAFF is based on a standard protocol (see Appendix 7). Broadly, a thorough epidemiological investigation by MAFF into the circumstances of each breakdown results in its assignment to one of six possible causes: transmission from neighbouring farms; introduction of infected cattle from Ireland; introduction of infected cattle from elsewhere; transmission from humans; transmission from badgers; or unknown or obscure.

4.2.6 MAFF currently attributes between 80% and 90% of breakdowns in South-West England to badgers. However, attribution of cause is rather subjective, and not always adequately supported by the evidence. It is therefore difficult to draw firm conclusions from these data.

4.2.7 We therefore recommend that current procedures for attribution of the cause of herd breakdowns should be made more transparent. More detailed data should be gathered for each individual breakdown, classifying it according to the presence or absence of badgers in the area and whether or not infection has been detected in any badgers present, including the severity of the disease, (together with the sample size). This information would, of course, be additional to other relevant information (e.g. on involvement of purchased cattle, contiguous infection etc.) which should continue to be recorded. Ideally, badgers would be sampled to collect data on infectivity for all breakdowns. However, we recognise that this would be costly and so, at this stage, we recommend merely that, where possible, any information available on prevalence should be recorded (e.g. from road traffic accident data). Sampling of badgers would, however, be necessary for the areas included in the statistical analysis of the relative contribution of different factors to the risk of herd breakdown recommended in paragraphs 4.6.16 and 4.6.17 below.

4.3 Spatial and temporal patterns of *M. bovis* infection in badgers

4.3.1 Data on *M. bovis* infection in badgers comes from carcasses submitted to MAFF for post-mortem. The sources of these carcasses are shown in Figure 4.3: by far the most important sources are badger removal operations (MAFF-taken badgers) and carcasses found at the side of roads, presumably as a result of road traffic accidents.

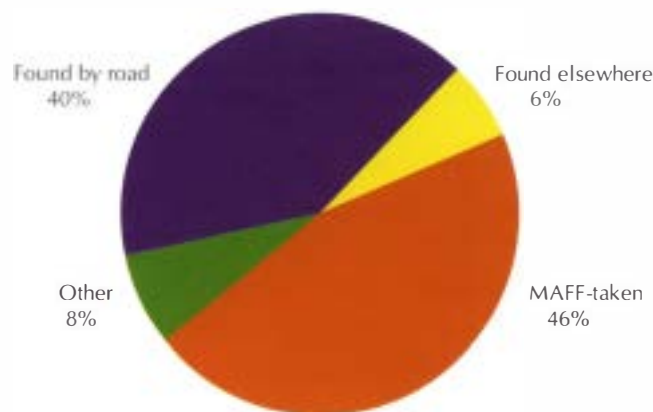

Figure 4.3 – Source of 41,526 badgers submitted to MAFF for post-mortem 1972 to 1996.

Road traffic accident badgers

4.3.2 A national survey of badger carcasses was initiated in 1972 after it was first recognised that badgers could be infected with *M. bovis*. Its aims were limited to assessing the geographical extent of infection in Great Britain. The survey gained momentum in 1976 with the start of extensive badger control operations and the restatement of an earlier commitment to examine badger carcasses submitted by the public for evidence of TB. The survey was formally discontinued on 3 August 1990, largely on cost grounds. Since then, road traffic accident carcasses have, on occasion, been collected in some locations in response to herd breakdowns.

4.3.3 The survey was not designed to answer questions about disease prevalence or incidence or badger density except at the crudest level. The samples were biased, depending on the public's interest and awareness of TB problems in local badgers and cattle. The cessation of the main survey in August 1990 meant that subsequent samples were biased, probably increasingly, towards areas of high herd breakdown rates (and also probably high badger TB prevalence). Thus, even allowing for the fact that post-mortem and culture probably does not detect all infected animals, the prevalence of infection in road traffic accident badgers is likely to over-estimate the true population prevalence. In addition, as sampling is sparse in both space and time, data on road traffic accident badgers are consistent with a wide range of population prevalence values.

Badgers from MAFF removal operations

4.3.4 Badgers from removal operations have been submitted for post-mortem since the clean ring strategy. The number has increased dramatically during the period 1975 to 1996. Sampling was intense, resulting in good estimates of the prevalence of *M. bovis* infection, but biases make these samples unrepresentative of the entire badger population.

Spatial patterns of infection in badgers and cattle

4.3.5 Determining the extent of spatial clustering of *M. bovis* infection in badgers is difficult due to the way in which carcasses are sampled. MAFF-taken badgers and road traffic accident badgers after 1990 are sampled intensively over a small area, and so have a good chance of detecting infection but are mainly taken from the clusters of herd breakdowns (see Appendices 8 and 9). Road traffic accident badgers (at least before August 1990) are sampled relatively randomly, but at low levels such that *M. bovis* (even at a high prevalence) would be very hard to detect and cluster size almost impossible to estimate (see Appendix 9).

4.3.6 Prevalence of *M. bovis* infection in badgers and herd breakdown rates are correlated: prevalence in badgers tends to be higher in areas of high breakdown rates. However, this may be an artefact of sampling these areas more heavily. Moreover, in some areas the correspondence between infection in cattle and in badgers is not clear cut: infection in badgers is detected in areas where herd breakdowns are not common, whilst in other areas, for example in Dyfed, relatively little infection is found in badgers where there is a high risk of herd breakdowns.

Temporal patterns of infection in badgers and cattle

4.3.7 Temporal trends in prevalence of infection in badgers submitted for post-mortem differ widely according to the source of carcasses. The different sources sample the population in different ways, making it difficult to estimate the true population prevalence.

4.3.8 In addition, the two main sources of data on TB prevalence, MAFF-taken and road traffic accident badgers, have both been sampled differently over time, thus further confounding any analysis of temporal trend. For example, comparison of TB prevalence between the clean ring and the interim strategy is obscured by the large number of uninfected badgers removed as part of the clean ring strategy. Even during a single control strategy, small shifts in sampling bias may obscure any real change in TB prevalence over time.

4.3.9 Figure 4.4 shows the TB prevalence in MAFF-taken badgers from 1975 to 1996 (see also figures at Appendix 10). This has increased at roughly the same rate since 1982 apart from two peaks in 1988 and 1993. It is highly unlikely that sampling bias could have caused these large peaks of prevalence, although the gradual change in TB prevalence may well be due to shifts in sampling.

4.3.10 Figure 4.5 shows the number of road traffic accident badgers and the TB prevalence in England and Wales from 1972 to 1996 (see also Appendix 11). Road traffic accident badgers before August 1990 offer the least biased data on TB prevalence.

The peak of TB prevalence seen in MAFF-taken badgers in 1988 is not seen in the prevalence of TB in road traffic accident badgers. A peak of TB prevalence in 1993 is seen for both MAFF-taken and road traffic accident badgers, but these badgers are both sampled from areas of high herd breakdown rates.

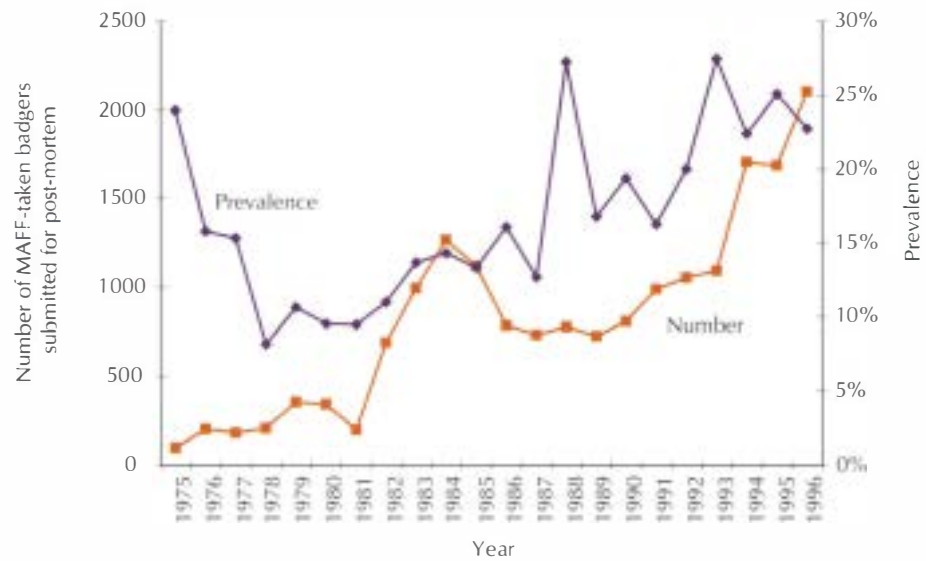

Figure 4.4 – Number of MAFF-taken badgers and prevalence of *M. bovis* infection 1975 to 1996 in England and Wales.

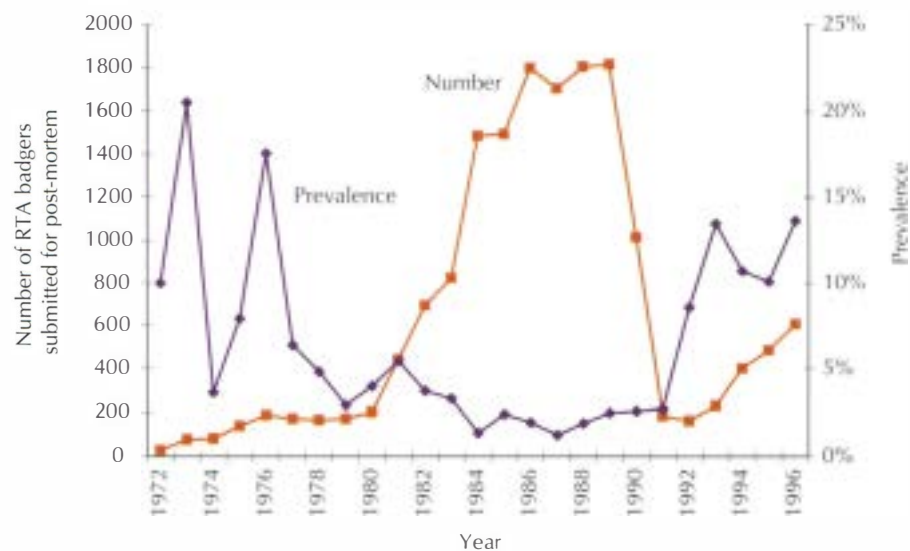

Figure 4.5 – Number of road traffic accident (RTA) badgers and prevalence of *M. bovis* infection 1972 to 1996 in England and Wales.

4.3.11 The increase in TB prevalence in road traffic accident badgers correlates with the increase in confirmed herd breakdowns. However, the relationship between prevalence and herd breakdowns is different for road traffic accident badgers submitted

between 1986 and 1990 and those submitted after 1990 (see Figures 4.6(a) and (b)). Whilst it is possible that the increase in prevalence of TB in road traffic accident badgers reflects a real increase over time in the population level prevalence, it may also reflect a shift to sampling in areas of high herd breakdown rates after 1990.

Figure 4.6 – The relationship between the number of confirmed breakdowns and TB prevalence in road traffic accident badgers 1986 to 1990 and 1991 to 1996 in:

(a) South-West England,

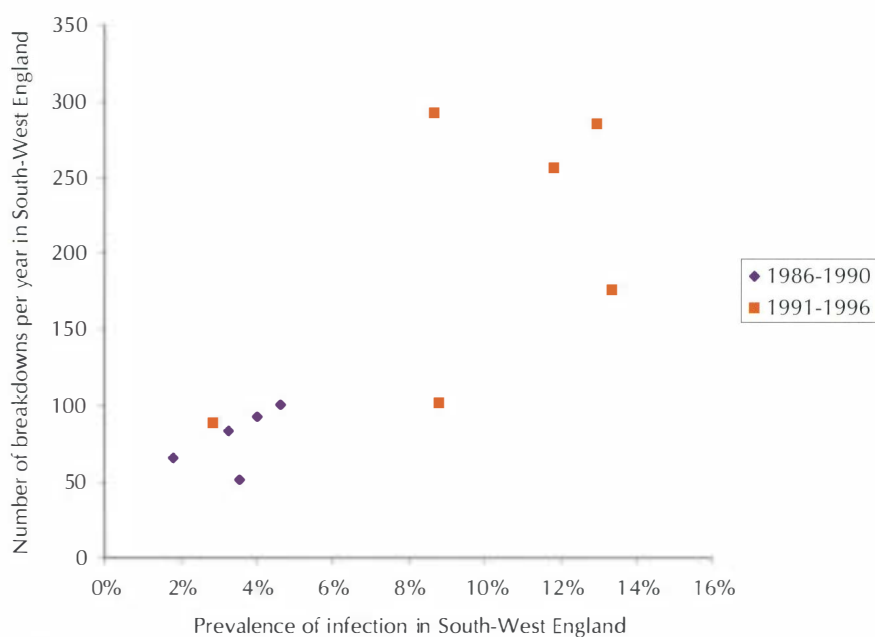

(b) the rest of England and Wales.

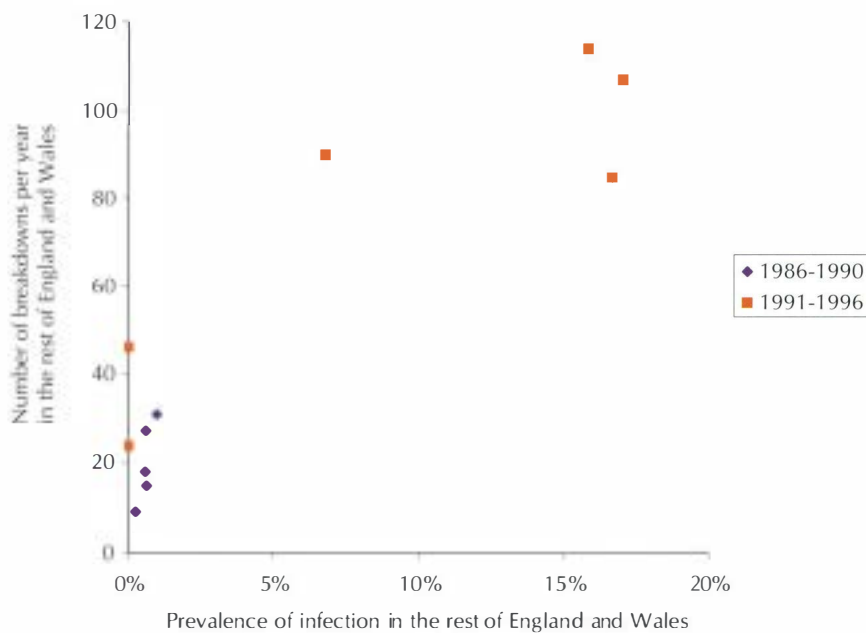

4.3.12 Given biases in the data we cannot easily separate out spatial and temporal patterns of *M. bovis* infection. It is therefore difficult meaningfully to relate data on *M. bovis* infection in badgers to data on herd breakdown rates. These problems are further exacerbated by the paucity of data available following the cessation of the road traffic accident survey.

4.3.13 The survey of road traffic accident badgers offered the least biased source of data on the underlying disease prevalence. Cessation of this resulted in a loss of valuable information, particularly for areas of new breakdowns such as Staffordshire, where there are no data on TB in badgers after 1991. We therefore recommend reintroduction of the survey but restricted to specific areas. Areas with high, or increasing, breakdown rates and nearby areas with low breakdown rates should be targeted. This will facilitate a more rigorous analysis of the link between herd breakdowns and badger TB prevalence over time and space.

4.3.14 One other factor which needs to be borne in mind is that the severity of the disease in badgers may be more important even than the overall prevalence of infection: severely affected badgers would excrete large numbers of organisms. The severity of the disease, and by implication factors influencing this, is therefore likely to be an important variable in transmission to cattle. Assessment of this should therefore form an important part of any survey of infection in badgers.

4.4 Molecular typing of *M. bovis*

Questions to be addressed by molecular typing

4.4.1 Recent progress in molecular genetic analysis of mycobacteria has resulted in development of techniques for identification of strain diversity (Collins *et al.* 1993; Skuce *et al.* 1996; Aranaz *et al.* 1996). These have been used to monitor transmission routes of human TB, for example, and to distinguish disease caused by reinfection from that associated with reactivation of infection. Analogous strategies can be used for *M. bovis*. Molecular typing could make a contribution in several important areas as set out below.

- (i) Maintenance of a national register of *M. bovis* isolates will improve epidemiological monitoring of changing patterns of herd breakdown.
- (ii) Typing of *M. bovis* isolates from different species over a sufficient period of time may generate definitive evidence to support the hypothesis of badger to cattle transmission in the field situation and quantify its occurrence or to indicate another mechanism underlying the observed association.
- (iii) Similarly, strain typing could be used to confirm cattle to cattle transmission in those cases where breakdown is believed to arise from introduction of an infected animal from another affected herd.
- (iv) Use in future surveillance of badgers may provide information on the spread of infection of *M. bovis* between badger populations.
- (v) It may be possible to identify which mycobacterial strains cross species barriers.

Molecular typing tools

4.4.2 Current tools for mycobacterial typing have been developed primarily for human TB. One of the most powerful, IS6110 fingerprinting (see Appendix 12), relies on detecting variations in the number and location of copies of a specific DNA fragment in the bacterial genome (van Embden *et al.* 1993). Such variation is detected using a technique known as restriction fragment length polymorphism or RFLP. The use of this technique to detect variation in IS6110 is more restricted for bovine TB because only a low number of copies of the DNA insert are found in most *M. bovis* isolates (Collins *et al.* 1993).

4.4.3 IS6110 typing, in combination with RFLP typing using additional probes (PGRS and DR), has allowed differentiation of 39 strain types in 210 *M. bovis* isolates in Northern Ireland, although 43% of these isolates were classified as a single RFLP type (Skuce *et al.* 1996). No clear evidence of host restriction of strain types was found. Further typing studies have identified 48 RFLP types within 310 *M. bovis* isolates of different species, temporal and geographical origins. These have demonstrated that TB breakdowns on individual farms, for which multiple isolates are available, may be due to more than one strain, suggesting multiple sources of infection (R.A. Skuce, personal communication).

4.4.4 Alternative genetic fingerprinting techniques, including a PCR-based 'spoligotyping' (SPacer-OLIGOnucleotide TYPING) assay, offer a potentially broader application to *M. bovis* (Aranaz *et al.* 1996). These assays require further development to improve levels of discrimination. For example, DANI have shown that DNA typing of 151 *M. bovis* isolates identified 40 types by RFLP but only 18 by spoligotyping (R.A. Skuce, personal communication). This is a rapidly advancing area of research, and tests suitable for addressing the questions outlined above are likely to be available over the next one to two years.

4.4.5 Another useful technique known as restriction endonuclease analysis (REA) has been developed in New Zealand. It has been used for several years to trace *M. bovis* isolates responsible for herd breakdowns involving imported cattle and transmission from possums (Collins *et al.* 1986; Collins *et al.* 1988; Collins *et al.* 1993; de Lisle *et al.* 1995).

4.4.6 Leading researchers on *M. bovis* molecular typing communicate on a world-wide basis. One important initiative, sponsored by the EU, involves the establishment of standardised typing procedures, a standard nomenclature for *M. bovis* strains and a database of DNA types. A longer term goal will be to develop DNA-based tests that identify differences in biological properties (virulence, species-specificity, etc.) between strains. Related research directed towards human TB has been promoted by a programme to determine the complete sequence of the genome of *M. tuberculosis* (Cole 1996), and a corresponding analysis of the genome of *M. bovis* would provide an important experimental advance in this area.

Use of molecular typing by MAFF

4.4.7 Two techniques, spoligotyping and RFLP, have been used to look at the epidemiology of *M. bovis* in the UK. Spoligotyping is quicker, simpler and cheaper to perform than RFLP and large numbers of isolates can be typed at the same time. In addition, it generates data that is more suitable for computer analysis than RFLP (Aranaz *et al.* 1996). MAFF have therefore used spoligotyping retrospectively to type isolates of *M. bovis* to help describe national patterns of TB infection in badgers and cattle. Some preliminary results are summarised below.

4.4.8 Figures 4.7 and 4.8 show the location of different cattle spoligotypes. Although some spoligotypes (e.g. 9 and 17) are widely spread, the majority are found in clusters consisting of one or two strains, with different strains in different clusters. More intensive sampling is required to show whether these geographical clusters are real or an artefact of sampling. If clustering is not an artefact of sampling, the geographical stability of some types might suggest a reservoir of infection which is relatively immobile. This would accord with a reservoir in a wildlife species such as the badger, which rarely makes movements of more than one to two km (paragraph 3.3.19).

4.4.9 Spoligotypes from badger isolates also appear to show some clustering (see Appendix 13). However, sample sizes are much smaller than those for cattle, making it even more difficult to establish whether these clusters are real or artefacts.

4.4.10 More than one isolate (between 2 and 18) was available from 86 breakdowns (85 farms). Isolates from the same breakdown were found to have identical spoligotypes with 11 exceptions: in ten cases, two spoligotypes were differentiated; and in the eleventh, in which 18 isolates were typed, four different spoligotypes were found. More than one source of infection seems to be involved in these 11 (13%) herd breakdowns where more than one spoligotype was found. The histories of such cases would deserve further investigation, especially if links with infection in other species are suspected.

4.4.11 For 49 cases, isolates were available from both badgers and cattle. Of these, 41 (84%) had a shared spoligotype between badgers and cattle (see Figure 4.9), with shared spoligotypes tending to be different in different areas. However, the presence of a shared spoligotype does not necessarily indicate a common route of transmission, especially with the limited strain differentiation of spoligotyping. Conversely, absence of a shared spoligotype may be an artefact of poor sampling rather than evidence against a common route of transmission, as there may be several spoligotypes in a given area.

4.4.12 In principle, monitoring *M. bovis* strains over time in cattle, badgers and other potential wildlife reservoirs would provide conclusive evidence on whether, and to what extent, badger to cattle transmission takes place. We therefore recommend extending the use of molecular typing tools with more intensive sampling of badgers, cattle and other wildlife over restricted areas in a well-designed experiment. To improve strain

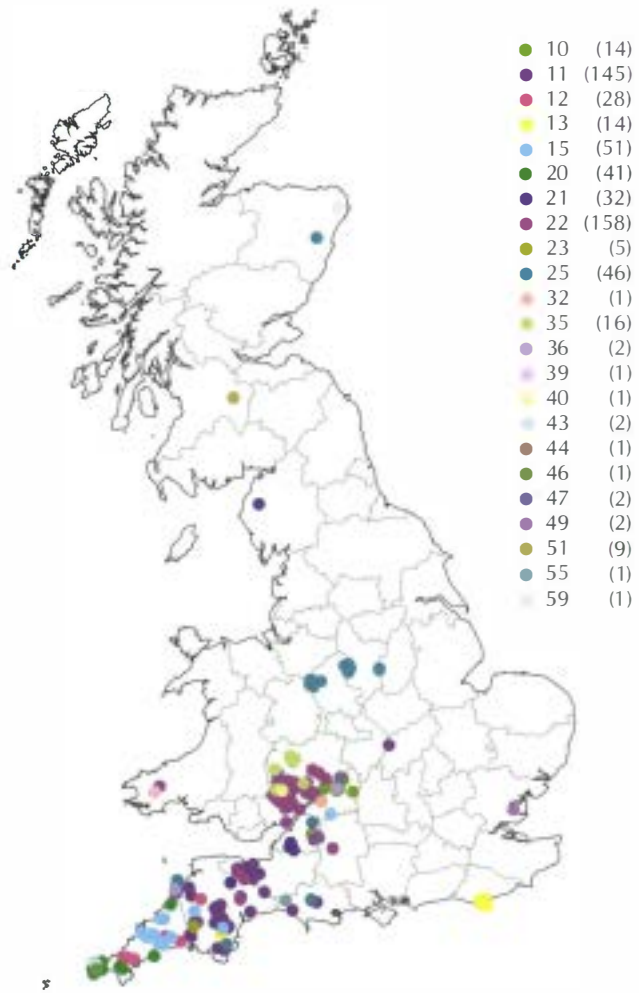

Figure 4.7 – Distribution of spoligotypes in cattle (except 9 and 17).



Figure 4.8 – Distribution of spoligotypes 9 and 17 in cattle.

differentiation, the optimal procedure would involve a combination of two or more methods of molecular typing.

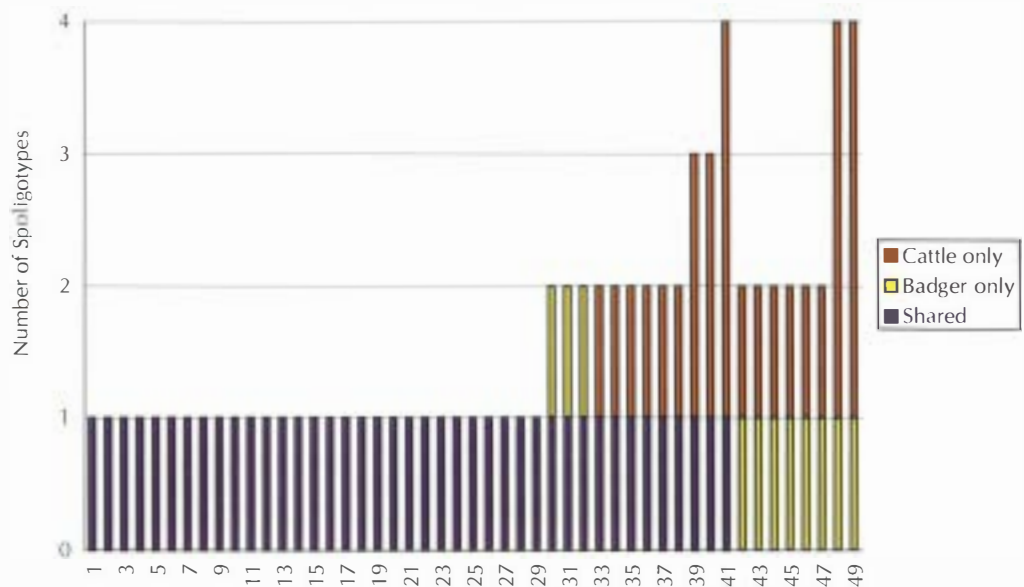

Figure 4.9 – Spoligotypes of isolates taken from cattle and badgers at the same time and place.

4.5 The use of mathematical models to understand the epidemiology of *M. bovis*

4.5.1 Cattle TB control programmes typically have two main goals. Firstly, they seek to isolate the disease to prevent disease spread. In Britain this has involved placing TB infected herds under movement restrictions. Secondly, they seek to control or eradicate the disease. In Britain this has involved culling infected cattle and, since 1975, badgers. Other interventions (e.g. vaccination – see section 6.4) may be available in the future. Mathematical models can be used to help understand existing data and to guide collection of data in the future in order better to achieve the two goals set out above. Several studies have modelled transmission of TB in badgers, helping us to understand key processes in transmission and how different interventions may affect transmission.

Models of TB transmission in badgers

4.5.2 Many models build upon the simple model developed by Anderson and Trewhealla (1985) which examined the effects on TB transmission of including pseudo-vertical transmission, a carrier state, an environmental reservoir of *M. bovis* and age structure. It highlighted several important points underlying the epidemiology of TB in badgers such as the potential importance of density dependence, interaction between badger densities and the environment, dispersal patterns between social groups, pseudo-vertical transmission and environmental reservoirs of *M. bovis*.

4.5.3 Anderson and Trewhella's simple model has subsequently been elaborated. Bentil and Murray (1993) found that when they included immune badgers in the model, they obtained patterns of prevalence similar to those seen in the Woodchester Park data, although their results may not be applicable to endemic infection of badgers (Ruxton 1996).

4.5.4 Swinton *et al.* (1997) used a similar model to compare the relative effects of fertility control versus lethal control, under the assumption that lethal control could potentially increase transmission whereas fertility control would not. This model suggested that even moderate levels of fertility reduction (although close to that which might cause local extinction of badgers) could decrease TB prevalence significantly. However, this may be a consequence of the lack of spatial structure in their model. In addition, it is likely that females which are not given anti-fertility treatment may compensate for those which are by having more offspring (see paragraph 5.5.4). They also found that modelled risk of infection in Woodchester Park remained roughly constant for 16 years despite a doubling of both badger population size and TB prevalence over the same period. Although this might mean that the risk of infection does not depend on badger density, it could also be an artefact of the assumptions of the model.

4.5.5 Whilst the simplicity of these models allows us to make clear, qualitative arguments about TB transmission, it does not allow quantitative comparisons between models and data and between the outcomes of different intervention strategies. Ruxton (1996) has argued for the inclusion of chance and spatial effects in models to allow us to make such comparisons.

4.5.6 White and Harris (1995a, b), for example, used a more complex version of Anderson and Trewhella (1985) that included both age and sex structure, and took into account chance (stochastic) effects and the effect of space. They used this model to assess the relative efficacy of various control strategies and concluded that repeated annual vaccination stood a good chance of eradicating endemic TB. However, they used an unrealistically high level of TB-associated mortality, resulting in a 66-86% reduction in population density in infected areas, which has not been observed in the field. They simulated control by seeding their simulations with infected individuals, then immediately imposing control. This approach has been criticised as being unrealistic for an endemic disease such as bovine TB. They also equated the success of vaccination with eradication of the disease, rather than just reducing the prevalence of infection or reducing the infectiousness of infected badgers, which may be beneficial in reducing the number of herd breakdowns (see section 6.4).

4.5.7 Modelling work at Oxford University (C. Hitchcock and D. Macdonald, personal communication) involved the use of a stochastic, spatial version of Anderson and Trewhella (1985) in much the same way as White and Harris (1995a, b). The main aim of their model was to illustrate how increases in dispersal in response to a badger removal

operation (the ‘perturbation’ effect, see paragraphs 3.6.6 to 3.6.8) could compensate for the direct (removal of infected badgers) and indirect (lowering of badger density) reduction in TB prevalence. They ran their models in the absence of disease until equilibrium, then introduced TB. This may not reflect the UK situation, where badger densities appear to have been increasing over the last decade (Wilson *et al.* 1997).

4.5.8 Another approach is to focus on transmission within a small number of social groups rather than in a large population of badgers. Smith *et al.* (1995) used such a ‘micro-simulation’ approach to look at how TB spreads amongst six badger social groups. This approach was inspired by observations in Woodchester Park that transmission between social group territories was relatively rare (see paragraph 3.4.9). A variety of sub-models were proposed as little is known about the natural course of infection in wild badger populations. Pseudo-vertical transmission and a ‘super-infectious’ class were included in the model. The models suggested that long-term persistence of TB is possible in social groups only with eight or more members.

4.5.9 Additional modelling work by Graham Smith involved further parameterisation of Smith *et al.* (1995) from the Woodchester Park data and the effects of culling on either two or six out of the six interacting social groups in the model were investigated. Lactating females were assumed to infect either all or none of their young, and the effect of killing or releasing lactating females was investigated. In order to eradicate TB, all of the social groups had to be subject to culling. If all available individuals were available to be culled, eradication was usually achieved by badger extinction. If a perfect (100% sensitive and specific) live test were available, the disease could be eradicated without increasing the risk of badger extinction significantly. The model also suggested that, although killing lactating females reduced TB prevalence in the short term, it resulted in the long-term local extinction of the badger population. This research suggests that achieving the desired goal of maintaining a badger population with low levels of TB is extremely difficult if lactating females are present.

Directions in the modelling of TB

4.5.10 Mathematical modelling is an important tool in understanding the epidemiology and control of *M. bovis* in badgers. Modelling studies have, so far, taken one of two complementary approaches. The first (e.g. Anderson and Trewhella 1985) uses relatively simple analytical models that can be used to identify potentially important factors in disease transmission. The second (e.g. White and Harris 1995a, b) involves complex, detailed simulations that could, in theory, be used to simulate the effectiveness of different strategies of culling, vaccination or (in badgers) fertility control. However, at the moment there are insufficient data to parameterise the models. Nevertheless, modelling is a relatively fast and cheap method of exploring the outcome of different interventions.

4.5.11 Various modelling approaches can contribute to the understanding of disease transmission. The combined use of geographical information systems and epidemiological models may help to understand *M. bovis* transmission on a wide spatial scale. Statistical models can help design field trials to test the predictions of transmission models. By linking economic and transmission models, the costs and benefits of different control strategies can be assessed.

4.5.12 An integrative modelling approach is common practice in medical epidemiology and we recommend that future modelling work should adopt a more integrative approach. MAFF should harness external expertise, through links with universities, institutes and others to extend its capacity in this area. This will yield a better understanding of disease transmission and help develop and underpin future strategies for dealing with this.

4.5.13 Data are rarely gathered with the needs of research in mind. Little is currently known about spatial patterns of transmission of TB in cattle and badgers. Further research on the routes of TB transmission between badgers and cattle and the growing resource of molecular typing of *M. bovis* will help formulate better models. It will also help to develop a deeper understanding of the data. Better feedback between models and data is therefore essential if we are to maximise use of the data and the usefulness of data collected in the future. We recommend that there should be better liaison between modellers and MAFF to ensure that the data gathered are better able to meet research needs.

4.6 Possible factors underlying local patterns of infection in badgers and cattle

4.6.1 Identification of the factors underlying spatial and temporal variations in *M. bovis* infection in badgers and cattle would potentially allow us to identify areas at high risk of herd breakdowns which have not had a history of this and to develop intervention strategies to reduce risk.

4.6.2 Two important issues arise from attempts to determine these underlying factors. Firstly, one needs to make the distinction between correlation and causation. Finding a significant correlation between, say, herd breakdown rates and an environmental variable does not imply that the environmental variable causes high breakdown rates. Surrogate markers of high herd breakdown rate (regardless of whether they are directly causally related) may be extremely useful in determining areas which have not had a history of breakdowns but which are now at high risk. However, decisions on which intervention strategy to use must rely on variables that are causally related to breakdown risk.

4.6.3 Secondly, one needs to take into account the phenomenon known as multiple testing. The more correlations that are sought, the more likely it is that a correlation

arising purely by chance will be found. The criteria for accepting a correlation as 'significant' therefore have to take this into account.

4.6.4 Chapters 2 and 3 review several aspects of badger ecology which may underlie any TB transmission from badgers to cattle. We consider further below three variables which may account for spatial variation in the risk of herd breakdown: badger density, climate and land use, and make recommendations for further work in this area.

Spatial variation in badger density

4.6.5 A high badger density could in theory facilitate transmission of *M. bovis* to cattle by increasing the prevalence of TB in badgers. It has been suggested that there may be a threshold group size below which *M. bovis* cannot persist. Two mathematical models suggest that this threshold is eight members. If a high badger density is also associated with more crowding, increased stress could make uninfected badgers more susceptible to infection and infected badgers more likely to progress to active, infectious TB disease.

4.6.6 It is also possible that contact rates between badgers and cattle would be higher in areas of high badger density (see section 3.5). Whether this is important in increasing the risk of transmission to cattle depends upon the major route of transmission. Direct contact with live badgers is uncommon but is likely to increase with badger density, especially if the prevalence of active disease is high: behavioural changes of diseased badgers may make them more likely to come into contact with cattle. However, the contact rate between cattle and badger excreta may be the same across a wide range of badger densities, as badgers may increase scent-marking at lower badger densities.

4.6.7 Since breakdown risk is on a fine spatial scale, badger density estimates would also be required on a fine spatial scale to support or refute the hypothesis that spatial variation in badger density underlies spatial variation in breakdown risk. The national sett survey (see paragraph 3.3.3) suggests that high badger densities may be associated with high herd breakdown rates on a regional scale, but it does not provide evidence on a smaller (parish or herd level) scale. The Woodchester Park study has failed to show a relationship between measures of infection risk (which may be unreliable) and population density (Cheeseman *et al.* 1988b). Even if the effect of population density on infection risk is small at Woodchester Park, the wider applicability of these results is not known.

4.6.8 Detailed data on badger density over a large area would be difficult and expensive to obtain. Simply assessing the presence or absence of badgers would, however, be feasible on this scale. Analyses by DANI have suggested that the presence of badger setts or dead badgers on a farm was associated with a two to threefold increase in the risk of a herd breakdown there (when purchased cattle have been ruled out). Another important risk factor for a herd was being contiguous to a breakdown herd. Given that these contiguous breakdowns may also have been caused by badgers, the risk truly associated with badgers may be even higher than threefold.

4.6.9 The DANI study indicates such a large increase in risk associated with the presence of badgers, even ignoring exact badger densities, that carrying out a similar analysis in Great Britain should be given a high priority. Although badger surveying already takes place, it is restricted to herds with breakdowns of TB. We have recommended in paragraph 4.2.7 above that information on the presence or absence of badgers should be collected for all breakdowns in future. In addition, to enable a proper assessment of the contribution of badgers to risk, similar information should be gathered also for farms in low risk areas.

Spatial variation in climate

4.6.10 Climate may be important in the epidemiology of TB for many reasons. It affects the amount of food available to badgers and has been shown to be an important determinant of badger density, which may be related to TB prevalence (see above). When food availability is low, stress may speed progression to active excreting disease. Climate may also affect the survival of bacteria in the environment (see paragraph 3.5.3).

4.6.11 Herd breakdown rates are generally higher in South-West England, where it is generally warm and wet: these are ideal conditions for high levels of food availability for badgers and long survival times of bacteria. The annual herd breakdown rate has been found to be positively correlated with total rainfall and mean minimum temperature and negatively correlated with the daily number of sun hours and the maximum temperature (King *et al.* 1997). The risk of TB infection in badgers in Woodchester Park is correlated with summer rainfall: when rainfall is low, the risk of infection is high (R. Woodroffe, personal communication). However, even if this correlation reflects causation, it is unclear how the changes in the prevalence of infection in badgers relate to the risk of herd breakdowns.

4.6.12 Initial studies of the association between climatic variables and herd breakdown rates are promising. However, it is unclear whether microclimatic differences can account for the fine scale spatial variation in breakdown risk. Given that fine scale meteorological data are routinely gathered, we recommend that these data should be used in the multi-variate risk analysis recommended in paragraphs 4.6.16 and 4.6.17 to investigate whether they can be used to pinpoint small areas at risk of high breakdown rates.

Spatial variation in landscape features

4.6.13 White *et al.* (1993) argued that local variation in badger scent-marking behaviour due to linear features might influence the risk of *M. bovis* infection in cattle. Badgers tend to cross boundaries such as hedges and fences at predictable points, and mark these 'crossing points' with urine. Since each urination may contain hundreds of thousands of bacteria, grazing cattle in areas with many boundaries (and therefore many crossing points) might increase their risk of exposure to *M. bovis* (White *et al.* 1993).

4.6.14 In an attempt to test this hypothesis, White *et al.* (1993) sampled 1km² squares where multiple badger removal operations had been carried out, and compared their habitat characteristics with those of randomly chosen squares where no 'badger-related'

a The South-West region referred to here comprises the six counties of Avon, Cornwall, Devon, Gloucestershire, Somerset and Wiltshire.

breakdowns had occurred. Within three of six land classes (accounting for 33.8% of the land area of the South-West region^a), squares with multiple badger removal operations had more boundaries, and more heterogeneous habitat, than randomly chosen squares (White *et al.* 1993). In two other land classes (24.6% of the land area) multiple badger removal operations were associated only with high habitat heterogeneity, and in one other (33.2% of land area) there was no significant association (White *et al.* 1993).

4.6.15 These results suggest that variations in landscape may predispose some areas to multiple herd breakdowns, although the evidence for an independent effect of habitat boundaries is less substantial. White *et al.* (1993) discounted the effects of badger density because there were no correlations between main sett density and either the number of boundaries or habitat heterogeneity in any land class (Cresswell *et al.* 1990; White *et al.* 1993). However, a problem with this analysis is that group size is also an important component of badger density which may be important in the epidemiology of *M. bovis* and this is not reflected in sett density (see paragraph 4.6.5).

Correlates of local variation in risk

4.6.16 We do not currently understand why risk varies at the local level. Mathematical models (see above) have helped to explore the importance of variations in badger density, climate and landscape features in relation to breakdown rates. However, existing data are insufficient to address the fine-scale spatial variations in breakdown risk. We therefore recommend that relevant data is collected and an analysis carried out to determine the correlates of local variation in risk.

4.6.17 Relevant data, collected on a fine spatial scale, would include:

- (i) the presence of badgers;
- (ii) TB prevalence in badgers, including the severity of the disease, together with sample sizes;
- (iii) husbandry;
- (iv) climate; and
- (v) landscape variables.

This data should be collected from areas of high and low risk. Detailed data on herd breakdowns would be needed for the study, as would sampling of badgers in high and low risk areas. Other sources of information would include data from a more rigorous attribution of herd breakdowns, the recommended road traffic accident survey, and newly collected information. This would provide quantitative evidence on the relative importance of badgers and other factors contributing to herd breakdowns. It may also provide indications for future husbandry policies (see also section 5.7).

4.7 Conclusions and recommendations

4.7.1 Most breakdowns occur in areas where there is a past history of breakdowns and so data on past breakdowns appear to be a reliable indicator of future risk of

infection on a medium spatial scale. However, breakdowns are also increasing in areas with no recent breakdown history: these areas cannot be identified by analysis of historical data (Figures 4.1 (a) and (b) and paragraph 4.2.3).

4.7.2 The present MAFF protocol for attribution of the cause of herd breakdowns is not sufficiently rigorous. We recommend that additional information should be collected for all breakdowns on the presence or absence of badgers. In addition, data on prevalence of infection in badgers (including severity of the disease) and sample size should be collected for farms included in the study comparing farms with high and low breakdown rates to estimate the contribution of badgers to the risk of herd breakdown (paragraphs 4.2.6, 4.2.7, 4.6.17 and paragraph 4.7.8).

4.7.3 Data on *M. bovis* infection in badgers suffer from unquantifiable biases that make it difficult to establish the underlying prevalence of TB, particularly on a small enough spatial scale to assess any links between TB prevalence in badgers and herd breakdown rates. In general, infected badgers are found in areas of high breakdown rates and prevalence tends to be higher in these areas. However, this may be an artefact of sampling these areas more heavily (section 4.3).

4.7.4 A survey of road traffic accident badgers offers the best available source of data on the underlying prevalence of TB in badgers. We recommend a limited reintroduction of the road traffic accident survey, including assessment of the severity of the disease, targeting areas with high or increasing herd breakdown rates and nearby low risk areas (paragraphs 4.3.13 and 4.3.14).

4.7.5 Monitoring *M. bovis* strains over time in cattle, badgers and other wildlife should, in principle, provide conclusive evidence on whether and to what extent badger to cattle transmission takes place. We therefore recommend extending the use of molecular typing tools in a well-designed, intensive study targeting badgers, other wildlife and cattle over restricted areas. To improve strain differentiation, the optimal procedure would involve a combination of two or more methods of molecular typing (paragraph 4.4.12).

4.7.6 Future modelling work should adopt a more integrative approach. MAFF should harness external expertise to extend its capacity in this area (paragraph 4.5.12).

4.7.7 There should be better liaison between modellers and MAFF to ensure that data gathered are better able to meet research needs (paragraph 4.5.13).

4.7.8 We do not currently understand why risk varies at the local level. We consider that a multi-variate analysis to determine the correlates of local variations in risk should be given a high priority. Relevant data would include presence of badgers, TB prevalence in badgers (including the severity of the disease), husbandry, climate and landscape variables. Data should be collected for a number of high and low risk locations. This analysis would provide quantitative evidence on the relative importance of badgers and other factors contributing to breakdown risk (section 4.6).

5 Control strategies

5.1 Introduction

5.1.1 This chapter assesses previous control strategies and recommends a scientifically based approach to badger management for the future. In section 5.2 we compare the gassing, clean ring and interim control strategies with reference to several key features that may underlie their success or failure. Section 5.3 analyses the live test trial. Section 5.4 examines the effect of these four strategies on the prevalence of TB in badgers and on the herd breakdown rate. Section 5.5 briefly reviews fertility control as a potential control strategy. Section 5.6 recommends a properly designed experiment to compare the efficacy of different strategies in reducing TB in cattle. Section 5.7 considers the role of husbandry in reducing TB transmission and section 5.8 summarises the conclusions and recommendations in this chapter.

5.2 What are the key features of previous control strategies that may have affected their success?

5.2.1 Section 1.4 outlines the background to and development of the various control strategies since the early 1970s and section 2.5 describes the effects of four large-scale badger clearances. Appendix 3 outlines the detailed operational features of the gassing, clean ring, interim and live test trial strategies. Table 5.1 summarises key aspects of each strategy. Several features of the gassing and clean ring strategies may have made them more effective than the interim strategy in reducing the prevalence of TB in badgers and hence, *theoretically*, also reducing the risk of herd breakdowns. These are:

- (i) the larger area cleared;
- (ii) the higher efficiency of removal of infected animals; and
- (iii) the long-term prevention of recolonisation.

The analysis set out below illustrates the importance of striking the right balance between resource costs, the appropriate targeting of badgers to be removed and the effectiveness of removal.

Which badgers were targeted for removal?

5.2.2 Different control strategies targeted different groups of badgers for removal (Table 5.1) and so are likely to have different impacts on the prevalence of TB in badger populations.

5.2.3 The *gassing strategy* aimed to remove infected social groups (and in some cases, contiguous groups also) associated with the reactor cattle. Each operation typically covered an area of about 9km² around a herd breakdown. The experience of field workers and the location of setts were used to identify social groupings of setts. Whilst this requires relatively little manpower, it is generally not as accurate as bait-

	Gassing (1975-82)	Clean ring (1982-86)	Interim (1986 to date)	Live test (1994-96)
Sampling of badgers before removal	Yes	Usually, except where there had been recent TB in badgers or when removal was proactive following discovery of a dead infected badger.	No	Yes
Post-mortem examination of removed badgers	No	Yes	Yes	Yes
Revisiting of control areas to monitor and prevent recolonisation	Yes Recolonisation was prevented for 12 months after removal, further monitoring occurred for a further 12 months.	Yes Recolonisation was prevented for six months after removal.	From 1986 to 1989, recolonisation was prevented for three months after removal. No prevention of recolonisation after 1989.	No
Main method of removal	Gassing	Trapping	Trapping	Trapping
Which badgers did the strategy seek to remove?	Infected 'social groups' (determined by sett location and field worker experience) which had access to the reactor land; sometimes contiguous uninfected groups.	Infected and uninfected social groups (determined by bait-marking) were removed until a 'clean ring' of uninfected social groups was removed.	Badgers using the reactor land (or if this cannot be identified the breakdown farm).	Badgers from infected setts from all land used by the badgers that could have caused the index breakdown and land extending out beyond this to the boundaries of all land with cattle herds considered to be at risk from these badgers.
Area of removal	Medium (up to 10km ²), extending up to 1km from breakdown farm boundary.	Potentially large, but in practice, the mean area of removal was about 9km ² .	Small (mean area about 1km ²), the maximum size being set by the area of the breakdown farm.	Medium to large (mean area about 12km ²).
Efficiency of removal of targeted badgers	High	Medium-high Anecdotally 70-80% of each social group was removed. However not all infected social groups were detected by sampling.	Variable, depending on location, reactor land size, time of year and age structure of population. In practice only those using the land on the days trapping occurs are removed and this may not include all the infected badgers which may use the land.	Low, in terms of not removing all infected setts due to the high chance of not detecting an infected sett.
Duration of operations	Average 11 weeks survey and sampling of badgers. Removal period relatively short (about 1 week), but post removal operations were long (usually 12 but up to 24 months following initial gassing).	Average 16 weeks to survey and determine social group boundaries by bait-marking. Removal period potentially long but generally only around five weeks for the first tranche of social groups. Removal of further social groups to establish a 'clean ring' extended the total length of the operation to 25 months on average (including 6 months post removal operations).	In theory, the delay is short due to a pre-defined area of control. In practice, the backlog of breakdowns has resulted in long delays to the start of removal operations. Three months trapping plus three months prevention of recolonisation (1986-1989). Up to four months trapping only from 1990 (in practice average period only 13 weeks).	Delays pre-removal due to backlogs. Average nine weeks to survey and sample. Removal period relatively short (about three weeks). No post removal operations.
Policy on lactating sows	Killed indiscriminately (as were their cubs).	Released.	Released.	Released.

Table 5.1 – Important features of the four different control strategies.

a 'Reactor land' refers to the land used by a herd with reactors and on which TB may therefore have been contracted.

marking in determining territorial boundaries of social groups. Nor is it as systematic as the geometrical ('tessellation') method of determining social group territories as described in Appendix 14.

5.2.4 Infection status was determined by sampling two badgers from each social group, with a minimum of five badgers taken from the reactor land^a and the surrounding area. This low-level sampling gave a low chance of attributing infection to a particular group of badgers. However, it had a reasonable chance of detecting the presence of infection in badgers in the general vicinity of a breakdown.

5.2.5 The *clean ring strategy* sought to remove all infected social groups and contiguous groups from the area surrounding the breakdown until a 'clean ring' of uninfected social groups had been removed. Clean ring operations had the potential to cover large areas: in practice the mean area of operations was similar to the gassing strategy, probably because infection was 'clustered' within certain social groups rather than spread evenly throughout the badger population (see section 3.4).

5.2.6 Social group boundaries were established using bait-marking. Although generally more reliable than the method used in the gassing strategy, this is extremely time consuming. Moreover, it is ineffective in winter when badger activity is low, and difficult during late spring and summer when vegetation makes latrines difficult to find. As in the gassing strategy, only two badgers were sampled per group in order to assess its infection status and hence some infected groups may not have been detected during initial sampling. However, many truly infected contiguous groups, missed out during the initial sampling, were ultimately identified during the removal period as the area of operation extended outwards until a clean ring of social groups had been established. Hence the clean ring strategy was more likely to detect infected social groups than the gassing strategy.

5.2.7 The aim of the *interim strategy* was to remove all badgers from the reactor land (or, if the reactor land could not be identified, the breakdown farm) regardless of infection status. The maximum area of operations was thus restricted by the size of the farm. The mean area of interim operations was much smaller than the area covered in either the gassing or clean ring strategies (1km² compared to 9km²).

How long were the operations?

5.2.8 For the *gassing strategy*, the delay between the breakdown and removal operations was largely determined by the time taken to survey the area of the breakdown for badgers and assess their infection status. Removal operations were relatively short but post removal operations were long. Any setts that were recolonised within the twelve months following gassing were regassed. Samples of carcasses and faeces were obtained for testing for any subsequent recolonisations up to two years after gassing. If any sample tested positive, then the setts were regassed and monitoring continued.

If all the samples were negative, then faecal samples were examined at three monthly intervals for 12 months after reoccupation.

5.2.9 Bait-marking to determine social group boundaries involved a considerable delay between breakdown and removal for *clean ring* operations. Removal operations could also be lengthy. Firstly, trapping was used rather than gassing. It takes longer fully to remove a social group by trapping than by gassing. Secondly, the clean ring strategy had the potential to remove many more social groups than the gassing strategy, although in practice the area of removal proved similar. Thirdly, continuous assessment of social group boundaries and infection status to obtain the 'clean ring' prolonged operations. Recolonisation was prevented for six months after the removal operation.

5.2.10 In theory, *interim* operations should suffer little delay between breakdowns and the start of removals because the areas of badger removal are clearly defined. It does not require detailed surveying or determination of infection status. In practice, the delay has often been substantial (27 weeks on average in 1995). From 16 June 1986, when the interim strategy began, until the end of 1989, badgers were removed for a three month period, and recolonisation was prevented for a further three months, with checks being made one, two, two and a half and three months after the badger removal operations. MAFF abandoned the maintenance period from 1990 because they considered that any badgers caught at the two, two and a half and three month checks were unlikely to have been directly responsible for the breakdown. At the same time they extended the maximum period of the removal operation to four months, although, in practice, the average removal period has been about 13 weeks (including two weeks pre-baiting and delays) until there has been no further sign of badger activity on the reactor land for about a week.

How effective was removal?

5.2.11 Although no badgers from *gassing* removals were available for study, gassing appeared efficient in removing a large proportion of the social group. Once gassed, the sett entrances were blocked to maintain gas levels within the sett and to allow staff to see if they had been reopened. Setts were checked one and three days after gassing: any where entrances had been reopened (indicating survival within the sett and/or immigration) were regassed. Trap-shy badgers and lactating sows (and their cubs) were removed indiscriminately, as were large numbers of uninfected badgers.

5.2.12 For the *clean ring* and *interim strategies*, live cage trapping rather than gassing was generally used, although, exceptionally, snaring, shooting and netting were used. This had the advantage of providing carcasses for scientific investigation. However, trapping may be less efficient at removal due to trap-shyness and during times of low badger activity (i.e. winter) and the period from February to April, when lactating sows, if trapped, were released. Anecdotal evidence suggests that 70-80% of each social

group were removed in the clean ring strategy. During the interim strategy, badgers were trapped until there was no further sign of badger activity on the reactor land for about a week but, due to trap-shyness and changes due to migration, this may not indicate that a high proportion of badgers was cleared.

5.3 The live test trial

5.3.1 Appendix 15 analyses the live test trial and the key points are summarised below. The Dunnet report envisaged that a test that could detect infection in live badgers would be available by the early 1990s (Dunnet *et al.* 1986, paragraph 118). The ability to target only infected badgers for killing would minimise the number of badgers killed, whilst directly reducing prevalence of *M. bovis* infection and the risk of infection to other badgers and avoiding the removal of any possibly immune animals.

5.3.2 Unfortunately, the live test can detect on average only 41% of truly infected badgers, although some infected badgers are more easily detected than others. In addition, the live test may not discriminate between infected and immune animals (although immunity to TB, either innate or acquired, whilst strongly suspected, has yet to be demonstrated in badgers).

5.3.3 The live test trial began in November 1994. Given the poor sensitivity of the test, the aim of the trial was changed from removing individual infected badgers to removing all badgers using setts where one or more infected badgers had been caught. Badgers were removed from all land used by the badgers that could have caused the index breakdown and land extending out beyond this to the boundaries of all land with cattle herds considered to be at risk from these badgers (mean area about 12km²).

5.3.4 Low trapping efficiency coupled with poor test performance made it likely that many setts occupied by infected badgers were incorrectly diagnosed as being free from infection, even in extreme cases where there were many infected badgers with visible lesions, which are more easily detected by the live test. Figure 5.1 shows that, even with a high prevalence of *M. bovis* infection of 50%, with a live test sensitivity of 41%, at least three badgers would have to be caught in order to have a 50% chance of detecting infection within the sett. With a prevalence of 30%, about five badgers would need to be trapped to achieve the same probability of detecting infection in the sett. As only one trapping week (i.e. four trapping nights) was used to determine the infection status of badgers using a sett, often only one or two badgers were caught at each sett. This made it unlikely that an infected badger would be caught, even when there was a high prevalence of infection among the badgers using the sett; and even when infected badgers were caught, there was still a high probability that they would not be detected by the live test.

5.3.5 Given the poor performance of the live test, even at the sett level, a surprisingly high proportion of setts (39 out of 196 or 19.9%) were found to be used by infected

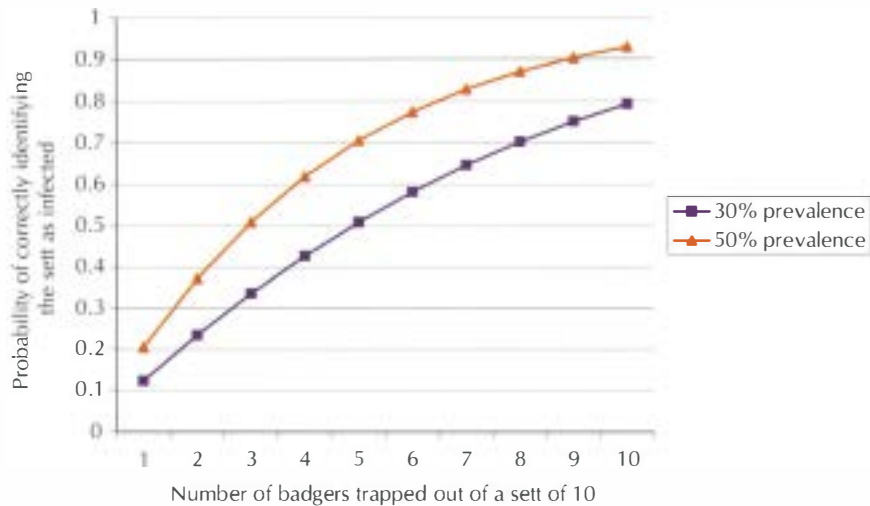

Figure 5.1 – The probability of obtaining at least one positive ELISA test from sampling a subgroup of ten badgers given an infection prevalence of 30% or 50%.

badgers. In view of the low average number of badgers trapped per sett, this figure is likely to be conservative and suggests that prevalence within setts may be extremely high.

5.3.6 Another difficulty in the trial design was that it did not take account of badger territoriality. Targeting individual setts rather than social groups, which often occupy several setts, risks partial removal of social groups and the changes in behaviour described in paragraphs 3.6.6 to 3.6.8. During the live test trial, 58% of social groups were only partially removed.

5.3.7 The live test trial involved considerably more staff resources than the interim strategy (118 person days compared to 77 person days, see Appendix 16). As a consequence, the mean duration of badger investigations in England increased from 16.7 weeks in 1994 to 21.2 weeks in 1995. The need to trap and test badgers entails a longer delay from herd breakdown to the beginning of the removal operation than under the interim strategy. However, the removal period itself was relatively short.

5.3.8 Despite the extra investment of staff resources to assess infection status, as Table 5.2 shows, the prevalence of *M. bovis* infection in badgers culled under the 'live test treatment' was not significantly different from that in the 'no live test' operations (these were the 'interim' operations which acted as experimental controls in the trial area). This indicates that the presence of badgers on the reactor land or breakdown farm is as good an indicator of infection as removal of badgers from infected subgroups of badgers from particular setts. The interim treatments in the trial show a higher prevalence than other interim treatments. This may be because the live test trial focussed on areas of high herd breakdown rates, and hence possibly areas of high TB prevalence in badgers.

	Clean ring strategy		Interim strategy		Live test trial	
	BROs	Maintenance	BROs	Maintenance	'Live test area' BROs	'No live test area' BROs
Total badgers caught	2,356	656	2,389	443	176	261
Number infected	334	92	446	76	66	89
% infected (95% confidence interval)	14.2 (12.8-15.6)	14.0 (11.4-16.7)	18.7 (17.1-20.2)	17.2 (13.6-20.7)	37.5 (30.3-44.7)	34.1 (28.3-39.9)

Table 5.2 – Number of badgers removed by MAFF during badger removal operations (BROs) and maintenance periods and the prevalence of infection under different control strategies.

5.3.9 The live test trial was suspended in September 1996 before enough data had been collected to determine whether there had been any significant effect on herd breakdown rate. The trial had poor statistical power: the live test treatment would have had to reduce the breakdown rate by 50% or more compared to the 'no live test' treatment over a five-year period in order for an effect to be likely to be detected. The fact that no farms were allocated to a 'no culling' strategy, made it even more difficult to assess the effects of the live test treatment.

5.3.10 As the prevalence of *M. bovis* infection in live test treatments was not significantly different from the 'no live test' removals, the only advantage that the live test treatment may have had over the interim strategy was the larger area of removal.

5.3.11 The design of the live test trial could be improved in two main ways: setts could be aggregated into social groups and more badgers could be trapped and tested. Aggregating setts into social groups results in a lower risk of partially removing social groups but results in only a modest increase in the chance of detecting infection. A longer period of removal would result in a similarly modest increase in the chance of detecting infection but would require greatly increased staff resources. We therefore conclude that the live test does not provide the basis for a cost-effective control strategy.

5.4 What was the effect of the control strategies on the prevalence of TB in badgers and on herd breakdowns?

5.4.1 Table 5.3 summarises what is known about the patterns of TB infection in badgers and cattle during the various control strategy periods. Section 4.3 explains the factors which obscure the trends in the prevalence of TB in badgers and in herd breakdown rates. This section assesses in more detail the available evidence on the effect of the control strategies on the prevalence of TB infection in badgers and on herd breakdowns.

5.4.2 None of the control strategies have been assessed in a properly designed experiment to establish their efficacy. Whilst removal operations may have had an effect on the prevalence of TB in badgers and on herd breakdowns, other factors may also

Control strategy	Patterns of TB infection in badgers	Patterns of herd breakdowns
Gassing (1975-1981)	No data from removed badgers. Prevalence in badgers sampled prior to removals high. Road traffic accident prevalence fairly stable.	Cattle breakdown rate fell. Reoccurrence of breakdowns on controlled farms fell. In large areas of effective removal, such as Thornbury, breakdowns were fewer for ten years after removal.
Clean ring (1982-April 1986)	Recolonising badgers had similar levels of TB infection to removed badgers. Prevalence of removed badgers higher than background prevalence.	Cattle breakdown rate low. Reoccurrence of breakdowns on controlled farms low but not as low as under gassing. In large areas of effective removal, such as Hartland, breakdowns were fewer for many years after removal.
Interim (June 1986-present)	Prevalence of infection in removed badgers higher than in clean ring. Recolonising badgers have a similar prevalence of TB to removed badgers. Road traffic accident prevalence relatively stable.	Breakdown rate increasing. More larger breakdowns. More NVL breakdowns. More breakdowns in areas without a history of TB infection. Reoccurrence of breakdowns higher than for clean ring and gassing strategies.
Live test trial (from November 1994 to September 1996)	Prevalence in badgers removed in live test treatments not significantly different to those removed in 'no live test' treatments.	Not enough statistical power to detect a significant difference.

Table 5.3 – Patterns of TB infection in badgers and cattle by control strategy.

have influenced these. In the absence of scientific controls, it is not possible to separate out the effects of badger removal from these confounding factors.

TB prevalence in MAFF-taken badgers

5.4.3 No information on TB prevalence is available for badgers killed during gassing operations because carcasses were not available for post-mortem examination. However, information is available for badgers that were sampled to assess the infection status of social groups: between 1975 and 1981 prevalence fell from 24% to around 10% (see Appendix 10). It is unknown whether sampling during this time was consistent: if not, this drop could be an artefact of shifts in sampling.

5.4.4 Trapping, as used in post-gassing strategies, has the advantage that removed badgers are available for post-mortem. In Table 5.2 the total badgers caught and the number infected during removal and any maintenance stages are shown for the clean ring and interim strategies and for the two live test trial treatments ('live test' and 'no live test' i.e. 'interim' treatment). The prevalence was high (higher than in road traffic accident badgers), without any significant difference between prevalence in the maintenance stages and that in the removal operations. This suggests that infected badgers must have moved into the area and/or that uninfected badgers acquired infection after moving in.

5.4.5 The data on prevalence of *M. bovis* infection in badger removals (see Figure 4.4 and Appendix 10) involve badgers mainly from the areas of herd breakdown clusters in South-West England. They show that TB prevalence increased during each control strategy, although inconsistent sampling could in theory be responsible for this pattern. The prevalence has risen from 1978 onwards, with two peaks in 1988 and 1993. Although prevalence is higher during the interim strategy compared to the clean ring, this may reflect the larger number of uninfected badgers removed as part of the clean ring strategy rather than the control strategies having different effects on badger prevalence.

TB prevalence in road traffic accident badgers

5.4.6 Figure 4.5 and Appendix 11 show the proportion of road traffic accident badgers infected with *M. bovis* from 1972 to 1996 in England and Wales. Before 3 August 1991, when the road traffic survey ceased, prevalence was fairly constant over time, and consistently higher in South-West England.

5.4.7 Prevalence in road traffic accident badgers before 1991 is generally much lower than prevalence in MAFF-taken badgers. After cessation of the national road traffic accident survey in 1991, road traffic accident badgers were usually submitted only from areas of herd breakdowns: prevalence then increased and became similar to that detected in MAFF operations. The small number of datapoints from the road traffic survey, and the biases after 1991 in the way in which road traffic accident badgers were sampled, make it very difficult to assess whether badger removals are associated with a change in the prevalence of infection, and hence whether different control strategies had different effects on prevalence. However, it is clear that prevalence of *M. bovis* infection was generally high in areas of high breakdown rates.

Herd breakdowns

5.4.8 Figure 1.1 and Appendix 2 show the proportion of total herds with confirmed and unconfirmed breakdowns from 1962 to 1996 in South-West England and in the rest of England and Wales. Before the gassing strategy in 1975, the proportion of herds with breakdowns in South-West England was fairly constant (at around 1.5% per year in the late 1960s and early 1970s) whereas the proportion of herds with breakdowns in the rest of England and Wales fell from 1.45% in 1962 to 0.25% in 1975.

5.4.9 During the gassing strategy, the proportion of herds with breakdowns in South-West England fell from 1.65% in 1975 to 0.4% in 1979. Although in 1976, the risk of importing infected cattle into Great Britain from Ireland was reduced, most imported cattle go to North-East England and Scotland. These data are consistent with (but do not prove that) the gassing strategy having been effective in reducing herd breakdown rates.

5.4.10 During the clean ring (1982-1986) and interim (1986 to present) strategies, the proportion of herds with breakdowns has risen in both South-West England and the rest of England and Wales. South-West England showed the greatest absolute increase (2.0% for South-West England, 0.44% for the rest of England and Wales) but the rest of

England and Wales showed the greatest relative increase (a 4.6 fold increase in South-West England, a 7.3 fold increase for the rest of England and Wales) during the period 1982 - 1996. However, the fact that breakdowns increased does not necessarily mean that these strategies were ineffective. We have no data on the number of breakdowns there would have been without them.

Recurrence of TB in individual herds

5.4.11 Repeated breakdowns in a herd are infrequent apart from in certain areas.

Figure 4.2 shows the location of herds in Great Britain that had more than one breakdown from 1987 to 1991 inclusive and from 1992 to 1996 inclusive. Of those herds that suffered breakdowns, only 9.8% (for the period 1987 - 1991) and 16.5% (for 1992 - 1996) had more than one breakdown (an average of 14.6% for the period 1987 - 1996). These recurrent breakdowns are found mostly in certain areas in South-West England.

5.4.12 The average time taken for 20% of herds that had badger removals to suffer another breakdown is shown in Table 5.4. Recurrence was least frequent in the gassing strategy, and most frequent in the pre-gassing period and during the interim strategy. Although it is tempting to speculate that the gassing strategy had the greatest effect in reducing the risk of herd breakdown, many other factors could have changed over the last twenty years that may also have had an effect on this risk.

	Period over which analysis was performed	Mean time for 20% of herds to experience a reoccurrence of reactors (years)
Pre-gassing	1966 to 1973	2
Gassing	1975 to 1981	6.6
Clean ring	1982 to April 1986	4.3
Interim	June 1986 to 1991	2

Table 5.4 – The mean time for 20% of those herds that (a) had reactor cattle and (b) that had some form of badger control (gassing, clean ring and/or interim) in the period 1975-1991 to experience a recurrence of reactors.

Note: for the pre-gassing period, data are available only for herds which underwent badger control in 1975 or thereafter.

Source: Wilesmith *et al.* 1993.

Outbreaks of TB in contiguous farms

5.4.13 Although most farms do not suffer recurrent breakdowns, many breakdowns occur contiguous to other breakdowns. The breakdown rate in contiguous herds has increased from 1987 to 1996. Although this suggests that the interim strategy is ineffective in preventing an increase in contiguous breakdowns, it does not tell us the effect of the interim strategy on contiguous breakdown rates as we have no data on what the contiguous breakdown rates would have been if there had been no interim strategy.

5.5 Prospects for fertility control as a TB control strategy

5.5.1 In terms of animal welfare, fertility control would probably be more acceptable than culling as a strategy to control TB in badgers. It might also cause less social perturbation. If the prevalence of TB in badgers were density-dependent, then controlling badger fertility might, in principle, reduce prevalence as effectively as culling. However, it has some significant problems.

5.5.2 Fertility control is most likely to be effective if targeted at females in the later stages of pregnancy (Macdonald *et al.* 1996; Tuytens and Macdonald, in press a; Tuytens and Macdonald, in press b). Since delayed implantation allows females to conceive at any time between February and November (see paragraph 3.3.12), agents which disrupt ovulation would have to act over timescales of many months. In contrast, the gestation period is short and its timing is relatively easy to predict.

5.5.3 The cheapest and most effective way of administering fertility control agents would be to place them in baits fed to badgers. Several chemosterilants are available which can be given orally. However, since these produce abortion by interfering with female reproductive hormones, they would almost certainly be unsuitable for use on land grazed by cattle. Furthermore, bait uptake might be low during pregnancy because badgers feed little during the winter.

5.5.4 Even if they could be administered safely, it is doubtful whether chemosterilants could substantially reduce population density. If 79% of females were pregnant (based on ultra-sound scanning data from Wytham), if 80% of pregnant females consumed the baits (an optimistic figure based upon bait uptake trials carried out in the Republic of Ireland), and if this triggered abortion in 80% of them (based upon trials of chemosterilants in cats and dogs), then 28% of females would still raise cubs under a fertility control strategy. This figure is not substantially smaller than the 31-58% of females that show signs of having raised cubs in study populations (Table 3.3). Since both the proportion of females breeding, and the subsequent survival of their cubs, are related to badger density (see 3.3.14 and 3.3.15), it seems likely that badger populations would compensate rapidly for fertility control at this level.

5.5.5 Epidemiological models suggest that fertility control could reduce the number of tuberculous badgers in a population, but they show that culling is more effective (Swinton *et al.* 1997). This is because culling removes animals of all ages, infected and susceptible, while fertility control removes only susceptible cubs.

5.5.6 We conclude that, despite its apparent advantages, fertility control appears to have only limited value as a potential control strategy to manage TB in badgers and that research in this area should not therefore have a high priority.

5.6 A scientific approach to future control strategies

5.6.1 Despite strong circumstantial evidence that badger culling may reduce herd breakdown rates, there has been no proper experimental study to enable conclusions to be drawn about the effectiveness, and also cost-effectiveness, of the different culling strategies. The only attempt at such a study, the live test trial, was terminated after less than two years. As Appendix 15 makes clear, there were serious flaws in the trial design.

5.6.2 No culling has been applied in Great Britain only at Woodchester Park where there has been no culling at all since 1979. Here the mean annual herd breakdown rate during the period 1986 to 1996 was 5.6% compared with 3.1% in the surrounding areas where the interim strategy was in force. These figures approach but do not reach statistical significance as the sample size is small. Furthermore, Woodchester Park may be an atypical area. There is, therefore, no scientific basis for assessing the impact either of culling or no culling strategies.

5.6.3 We recommend that the efficacy of culling should be evaluated experimentally in designated areas. We propose that three strategies should be compared:

- (i) a *reactive* strategy, which incorporates lessons learnt from previous strategies;
- (ii) a *proactive* strategy, where badgers are cleared from areas before any breakdown; and
- (iii) a *no culling* strategy.

These approaches are examined further below.

The reactive strategy

5.6.4 Based on our analysis of past strategies we recommend that the reactive strategy should aim to remove all badgers, including lactating sows (see paragraph 3.6.5), from all social groups, part or the whole of whose territory includes the breakdown farm (or the reactor land, if it can be rigorously identified). Removal operations should be carried out in response to all breakdowns on land allocated to the reactive treatment.

5.6.5 Given that proximity to the breakdown herd is associated with high levels of *M. bovis* infection in nearby badgers, and that infection is highly clustered in badgers, this reactive strategy will remove many infected badgers. Complete removal of social groups will avoid any potential problem of perturbation associated with partial removal. Such removals may not only reduce the risk of recurrent breakdown in the herd, but also have some pre-emptive effect on reducing herd breakdown rates in contiguous herds.

5.6.6 Social group boundaries should be determined using all available information. Bait-marking is desirable as it is often accurate, although during times of low badger activity or over large areas, bait-marking can be unreliable or too time consuming. In these cases, positions of main setts coupled with field worker experience should be

used. A simple geometrical method (the so-called 'tessellation' method) of attributing outlier setts to main setts in order to determine social groupings is described in Appendix 14. While other factors, such as topology, may have to be taken into account, such simple methods provide a quick and easy starting point to help minimise the delay between the breakdown and the beginning of the removal operation. Targets should be set and monitored to reduce the long delays between herd breakdowns and the start of removal operations.

5.6.7 The removal period should be long enough and the removal method efficient enough to ensure that all of the social groups that had access to the reactor land or breakdown farm are removed. Data from the clean ring and interim strategies suggest that no more than four months would be needed to ensure clearance of the local badger population.

5.6.8 Although trapping is the method used most commonly in England and Wales, it may not be an efficient method of removal, especially at certain times of year when badger activity is low and in areas where trap-shyness is common. Alternative methods of removing badgers, such as capture using stop-snares, should be considered under these circumstances, especially as this method (unlike shooting away from setts) allows attribution of badgers to certain setts. Efficacy, cost and welfare considerations should be taken into account in considering alternative methods.

5.6.9 Given the relatively small area of clearance (likely to be of the order of 10km²), recolonisation is likely to be rapid. Long-term prevention of recolonisation (such as that implemented in the gassing and clean ring strategies) would be desirable to prevent reinfection with *M. bovis*, either through infected badgers immigrating into the removal area and/or uninfected immigrants acquiring infection from persisting environmental bacteria in setts. However, the advantages have to be balanced against the substantial costs involved in revisiting and clearing previously cleared areas. We therefore recommend that the exact follow-up period should be further considered when the detailed experimental design is drawn up. In any event, given the lack of data on recolonisation times, we recommend further research on this in areas subject to the reactive and proactive control strategies.

The proactive strategy

5.6.10 Widespread clearances in areas such as Thornbury and Hartland were followed by large reductions in the herd breakdown rate (see paragraphs 2.5.6 to 2.5.10). A proactive strategy would similarly involve badger removal operations over an area of 10km by 10km with a history of high herd breakdown rates. Its aim would be to prevent all badger-related breakdowns in the vicinity.

5.6.11 Although such an approach would involve a large amount of surveying (with two to three person days required to survey 1km²), this could be done during the winter

when trapping efficiency is low. Removals could then commence as soon as trapping efficiency is high. Initially, high staff resources would be required to clear the designated areas. In subsequent years, fewer staff resources would be needed (as recolonisation would be relatively slow due to the large edge effects). It would be necessary to deal with renewed badger populations after two to three years to ensure the area remained clear. In addition the area would need regular monitoring for badger activity after the clearance. We envisage farmers could help with such monitoring. Focussing on the edges of the control area rather than regularly re-surveying the whole area could reduce resource costs.

5.6.12 If badgers cause a substantial proportion of herd breakdowns in the experimental area, a proactive strategy would give the earliest indication of this. Analysis of the data from the proactive strategy, and comparing this with the data from the no culling strategy, will allow the estimation of the *maximum* possible impact of badger management on herd breakdown rate.

The no culling strategy

5.6.13 A no culling strategy is necessary:

- (i) to establish the effects of no culling; and
- (ii) to act as a control for the two culling strategies (reactive and proactive).

The proactive and no culling strategies are essential elements of any experiment to establish the efficacy of culling. They provide benchmarks showing the minimum and maximum effects of badger removal against which the effectiveness of the reactive strategy can be compared in numerical terms. It is therefore in the interests of farmers that these elements of the experiment are included and properly implemented (see paragraph 5.6.37).

Management of the experiment

5.6.14 We recommend that an independent expert group (hereafter referred to as the Expert Group), including statisticians and mathematical epidemiologists, should be established to oversee the detailed experimental design. They should also monitor the progress of the experiment and regularly review the data (blind, to the extent possible):

- (i) to judge if the experiment is showing significant differences between the three treatments; and
- (ii) to determine an appropriate stopping point in light of the need for quantitative as well as qualitative results.

5.6.15 Another key function of the Expert Group would be to monitor the TB situation in areas outside the experiment and make recommendations on whether any new areas should be recruited into the experiment.

How are the control areas to be allocated?

5.6.16 The three strategies should be assigned randomly to avoid any bias in selection leading to inherent differences between the three treatment groups. They should also be assigned to relatively large areas to reduce interference between different strategies. Given lack of knowledge about the relative effects of each of the three treatments, equal numbers of areas should be assigned to each of them. If possible, natural barriers should be used to separate the different areas.

5.6.17 Since the aim of the reactive strategy is to *reduce* the risk of future breakdowns in both the breakdown herd and contiguous herds, it is likely to be most effective, and hence should be tested in areas, where either:

- (i) individual herds often have recurrent breakdowns; and/or
- (ii) the risk of contiguous breakdowns is high.

These two features are primarily restricted to certain areas with very high herd breakdown rates within South-West England. The effect of the proactive strategy (which aims to eliminate all breakdowns caused by badgers, not just recurrent or contiguous breakdowns) will also be greatest (and hence most readily assessed) within these areas of high breakdown rates.

5.6.18 In places where breakdowns occur infrequently and/or far apart reactive culling is not likely to be effective. Nor do we consider that the proactive strategy could be cost-effectively tested in such areas. As the analysis in Chapter 4 shows, the history of breakdowns in an area is a reliable indicator (the most reliable that we have) of future risk. We therefore conclude that the experiment should target those areas at highest risk of contiguous and repeated herd breakdown identified from analysis of the available data.

5.6.19 The Expert Group should finally determine the areas to be included in the experiment, having carried out a sensitivity analysis to further test the assumptions used in the approach suggested below. One approach would be to identify the highest risk areas using the following criteria applied to historic data.

- (i) We define *contiguous* breakdowns as ones occurring on or near (within 3km of) an index breakdown. We consider this to be the maximum distance over which contiguous breakdowns are likely to be caused by the same social group of badgers.
- (ii) *Repeat* breakdowns are defined as ones occurring on the same farm within a five year period of an index breakdown. We estimate this period is the maximum length of time over which the reactive strategy may have an effect.

5.6.20 Adding up the number of repeat and contiguous breakdowns in an area, gives an estimate of the *maximum* possible impact of the reactive strategy with two important caveats.

- (i) Not all recurrent or contiguous breakdowns are likely to be caused by badgers and clearly these would not be prevented by any of the proposed strategies.
- (ii) The reactive strategy is unlikely to be 100% effective in reducing the breakdown rate in the index and contiguous herds for the whole five year period.

We suggest that 10km by 10km squares (100 km²) are appropriate areas over which to aggregate the breakdowns, and that data on breakdowns from the most recent five year period (i.e. 1992 to 1996 inclusive) should be used to determine the areas which meet the criteria set out in paragraph 5.6.19.

5.6.21 It is essential that a sufficiently large area is included in the experiment to provide the necessary statistical power and hence results within an acceptable time-scale. A minimum of 30 10km by 10km squares should be included.

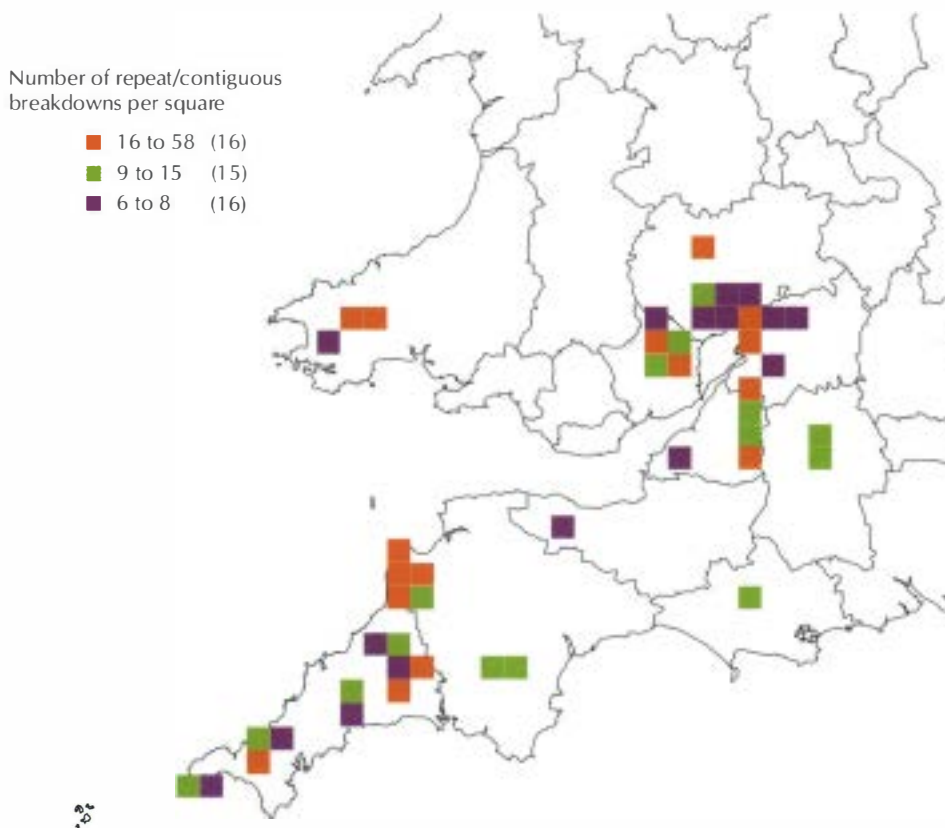

Figure 5.2 – Repeat and contiguous breakdowns, grouped in 10km by 10km squares, 1992 to 1996 (inclusive). Repeat and contiguous breakdowns are breakdowns that occur within a defined period (here, 1992 to 1996) and within a defined distance from an index breakdown.

5.6.22 Figure 5.2 shows the location of 10km by 10km areas in Great Britain which have suffered six or more repeat and/or contiguous breakdowns over the 1992 to 1996 period. The red squares depict the 16 squares which suffered most (between 16 and 58) repeat and/or contiguous breakdowns over that period and which would therefore be considered the highest risk areas. The 15 green squares are those which suffered between nine and 15 such breakdowns; and the 16 blue squares each had between six and eight such breakdowns.

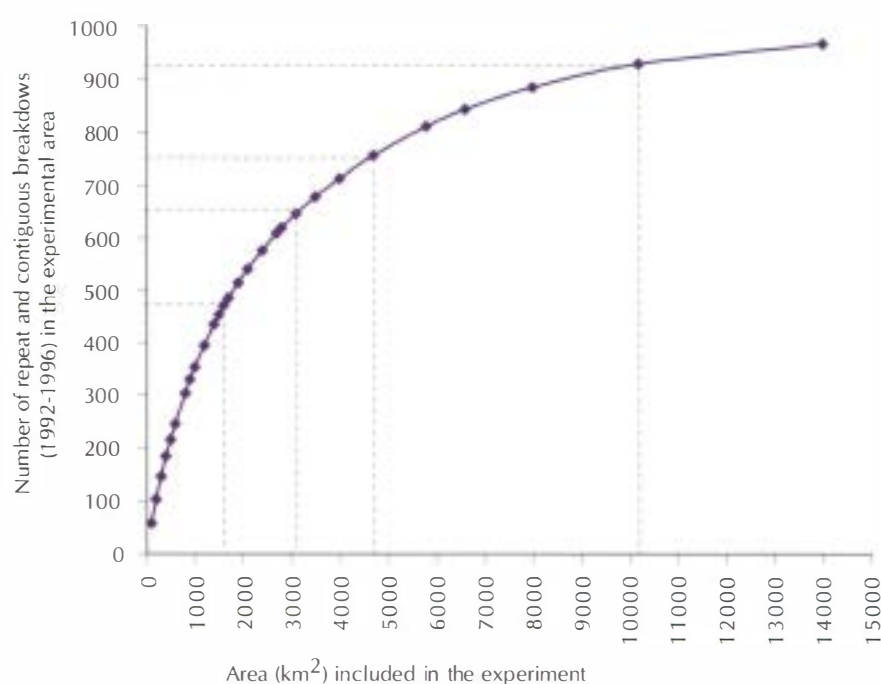

Figure 5.3 – The number of repeat and contiguous breakdowns (1992 to 1996) for a given area.

5.6.23 Figure 5.3 shows the area that would have to be included in the experiment to cover a given number of the total 966 repeat/contiguous breakdowns which occurred over 1992 to 1996. Thus, 49% of such breakdowns would fall in the 16 highest risk squares; 67% in 31 squares; 78% in 47; and 96% would occur in 102 squares. In other words, there is a curve of diminishing returns: a great many additional squares have to be added substantially to increase the coverage beyond 67%. We do not consider that either the resource costs or the effect on badger populations of such a large experimental area would be justified.

5.6.24 The Expert Group will need to weigh these issues in finally determining precisely which areas should be included once the further analysis referred to above (paragraph 5.6.19) has been completed. ‘New’ herd breakdown areas without a history of herd breakdown are, of course, not identified by our analysis. We recommend that

the Expert Group should consider whether there is sufficient evidence that any of these might represent a high, ongoing risk of herd breakdowns and, if so, whether they should be enrolled into the experiment.

Timescale for the experiment

5.6.25 If the Government accepts the recommendation for an experiment, we recommend that this should be implemented immediately. We expect that the proactive strategy may show a significant effect in reducing herd breakdowns in a timescale considerably shorter than five years if a substantial proportion of breakdowns is indeed caused by badgers. However, although *qualitative* results may be available after a couple of years, the longer period would be necessary to make full *quantitative* assessments with acceptable confidence intervals to serve as a basis for future policy.

5.6.26 Figure 5.4 illustrates the time it would take for the experiment to have a 90% chance of detecting a given percentage reduction in the breakdown rate for different baseline breakdown rates in the control area. For example, assuming that:

- (i) 50 breakdowns occur in the no culling areas in total,
- (ii) 50% or more of herd breakdowns in the experimental area are caused by badgers, and
- (iii) the proactive strategy removes all badgers,

an effect of the proactive strategy could be seen within the first year of the experiment.

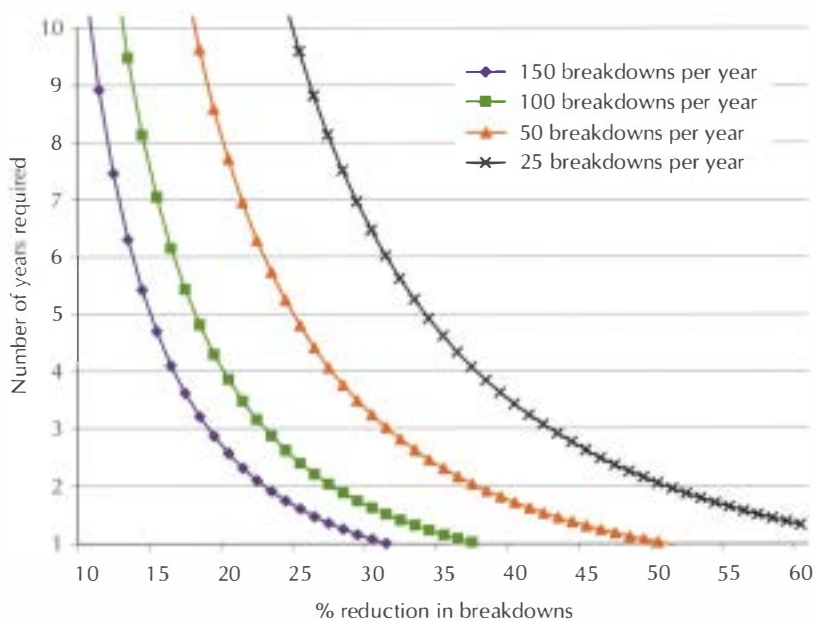

Figure 5.4 – The number of years required for the experiment to have a 90% chance of detecting a given percentage reduction in the breakdown rate for different baseline breakdown rates in the control area.

5.6.27 The impact of the reactive strategy would take longer to assess for several reasons. In the reactive strategy, breakdowns have to occur before control is implemented, thus delaying control and narrowing the difference in breakdown rates between the no cull and reactive strategy areas. If badgers are the primary cause of breakdowns, the reactive strategy is unlikely to be as effective as the proactive strategy in reducing the herd breakdown rate because there will be more rapid recolonisation. However, even if the reactive strategy can reduce breakdown rates by only 20% relative to the no cull areas, this effect should be detected within five years for the minimum recommended area of the experiment (i.e. 30 10km by 10km squares).

Effect on badgers

5.6.28 We estimate that the total number of badgers killed over the five years of the experiment is unlikely to be substantially different from the number removed if the interim strategy were to be continued. Moreover, it is likely to be substantially fewer than the number killed by road accidents over the same period. However, inevitably, the proposed strategy would *initially* involve killing more badgers than under the current interim strategy. This is a direct effect of the proactive strategy which requires total badger removal in the first year from the designated proactive areas.

5.6.29 Assuming that 10 proactive treatment areas of 100km² each are cleared, and that badger density in these areas is five per km², 5,000 badgers would be removed in this strategy in the first year. Assuming that 50 breakdowns in total occur in the 10 reactive treatment areas, and that an area of 10km² is removed per breakdown, this treatment might remove 2,500 badgers. Thus about 7,500 badgers might be removed in the first year of the experiment. Whilst this is many more than the number of badgers removed in removal operations in Great Britain in 1996 (about 2,000 badgers) this constitutes only a relatively small proportion of the total badger population and is likely to be many less than the number killed in road accidents (see paragraph 3.6.2).

5.6.30 In subsequent years, we estimate that the numbers removed will fall dramatically. Few badgers will be removed after initial clearance in the proactive treatment areas given the low recolonisation rates into such large areas. As regards the reactive strategy, the number of badgers removed depends on the underlying breakdown rate and the efficacy of the strategy. Assuming that 25 breakdowns per year occur in the reactive areas after the first year of the experiment, approximately 1,250 badgers would be removed each year. We recommend that the number of badgers removed each year is closely monitored by the Expert Group and that these data should be used in evaluating the results of the experiment (see paragraph 5.6.33).

Evaluating the results

5.6.31 At the end of the five year period of the experiment, and provided a scientifically based experimental design is adhered to, we would expect to have clear evidence on

the role of the badger in transmission of TB to cattle. There would also be adequate quantitative data to enable a full cost-benefit analysis of the different strategies, including no culling. Appropriate modelling should enable these results to be extrapolated to provide a basis for determining appropriate policies both for areas covered by the experiment and for other areas.

5.6.32 Although the experiment will inevitably have a cost, we consider that this is outweighed by its prospective benefits. It is the only way to assess the effects of both culling and no culling and whether culling is cost-effective. A similar experimental approach is common in clinical trials of therapeutic drugs in humans, where one group is given a placebo and another is given the drug. Even when an effect is demonstrated, this is balanced against the efficacy of the drug, its cost and any potential side-effects.

5.6.33 Similarly, even if the experiment shows culling to have an effect, it may not necessarily be a cost-effective approach. That is why a full cost-benefit analysis will be essential to provide a clear basis for future policy and to ensure that environmental and wider considerations are taken into account in evaluating the evidence. The magnitude of any effect of culling will have to be taken into account as well as the potential risk to human health and welfare, animal welfare (both badger and cattle), and farmers' livelihoods.

Action outside the areas of high risk of herd breakdowns

5.6.34 Among the options for action outside the areas of high risk of herd breakdowns are:

- (i) the reactive strategy, as proposed above;
- (ii) an extension of the experiment proposed above;
- (iii) no culling.

5.6.35 We recommend that there should be no culling outside the experimental area for two main reasons. Firstly, the logic of reactive culling is to prevent repeat or contiguous breakdowns. The experimental area is the area most affected by these breakdowns and includes the majority of them. Hence, even if reactive culling were effective in reducing breakdowns (and this remains to be tested by the experiment), extending it into areas of lower breakdown rates would provide diminishing returns in terms of the number of breakdowns prevented. Secondly, proactive culling on a much larger scale than the experimental area is neither desirable nor feasible.

5.6.36 However, as noted above, the Expert Group should closely monitor the herd breakdown pattern in areas outside the main experiment. It would be open to them to recommend recruitment of new areas into the experiment.

The farmers' role

5.6.37 The experiment will benefit farmers because it will provide definitive answers on what constitutes the most effective strategy. We recommend that further

consideration should be given to what farmers themselves might contribute. Farmers could potentially perform a substantial element of the operation (e.g. mapping setts, pre-baiting traps) with appropriate training and supervision from MAFF. They could also contribute to costs. Farmers in all the experimental areas might also be involved, for example, in identifying and recording badger activity. Given the importance of these issues for the industry, we believe there is significant scope for industry involvement both during and after the experimental period.

5.7 Husbandry

5.7.1 If the mechanism of transmission from badgers to cattle were known, it might be possible to prescribe preventative husbandry measures. In the absence of this knowledge, an heuristic experimental approach is suggested, as this could make an important contribution to reducing the risk of herd breakdowns.

5.7.2 MAFF has issued advice since 1986 that is available to the industry and is given to all farmers suffering herd breakdowns. This advice covers two main possibilities:

- (i) keeping cattle away from badger setts, urination trails and latrines; and
- (ii) keeping badgers away from cattle feeding troughs and out of farm buildings.

There is little evidence that the industry as a whole has made efforts to act on this advice. It appears that they have traditionally been reluctant to adopt measures because of a combination of logistical difficulties, perceived impracticalities, cost, conservatism and lack of convincing evidence that husbandry could have an effect.

5.7.3 We suggest that areas outside the experiment would be suitable for an experimental comparison of proactive husbandry methods. The power of the experiment would be reduced if too many different approaches were tested, so only the most promising should be included. Any such experiment should not interfere with the experiment designed to assess the efficacy of culling. The comparison of husbandry practices would form part of the multi-variate analysis of the risk of herd breakdowns recommended in paragraphs 4.6.16 and 4.6.17.

5.7.4 To illustrate the potential to detect the effects of husbandry, it can be shown that with a constant underlying risk of 100 herd breakdowns per year, a 17.7% reduction in risk due to husbandry would be detected with 90% probability in five years. If the risk of herd breakdown were increasing, then any effect of husbandry could be detected more quickly. Whether husbandry could actually achieve these levels of reduction in breakdowns depends not only on the efficacy of the practice, but also on the proportion of breakdowns truly caused by badgers. If less than 17.7% of breakdowns in areas participating in the husbandry experiment were caused by badgers, there would

be less than a 90% chance of detecting the impact of husbandry over five years, even with a practice which prevented all TB transmission between badgers and cattle.

5.7.5 We see two main mechanisms for achieving an experimental comparison of husbandry: the first would be an approach whereby the Government would take the lead in developing and running an experiment. The second approach would be for the industry to take the lead in securing industry support for such an approach and in making proposals for practical husbandry methods which might be appropriate (probably based on the MAFF guidance). The Government should act as facilitator and assist with the detailed experimental design and analysis of the experiment, with input from the Expert Group, as appropriate.

5.7.6 We recommend the second approach. It is essential that the industry recognises the role husbandry may have to play and that they fully take ownership of the issue: their firm support and commitment would be a prerequisite for a successful initiative in this area. We therefore consider that the second, co-operative approach would be best able to deliver results. As with the badger culling experiment, the benefits of any results will accrue to the farming industry.

5.7.7 As part of its role in encouraging a more proactive and constructive approach to husbandry, we recommend that the Government should also give further consideration to whether incentives might be offered.

5.8 Conclusions and recommendations

5.8.1 There is some evidence to suggest that the gassing and clean ring strategies were more effective than the interim strategy in reducing the prevalence of TB in badgers and hence also, theoretically, reducing the risk of herd breakdowns. However, in the absence of scientific controls, it is not possible to separate out the effects of badger removal from other confounding factors or to draw conclusions about the impact and cost-effectiveness of different culling strategies (section 5.2 and paragraphs 5.4.2 and 5.6.1).

5.8.2 The live test trial does not provide the basis of a cost-effective control strategy, primarily due to the poor performance of the ELISA test. Improving the trial design by operating it at the level of the social group and trapping more badgers for testing (paragraph 5.3.11) would result in only modest increases in the effectiveness of the trial.

5.8.3 TB prevalence in MAFF-taken badgers culled as part of removal operations has been high, and higher than road traffic accident badgers tested over the same period. Prevalence in MAFF-taken badgers has risen since 1978, with peaks in 1988 and 1993. Although data on TB prevalence in both MAFF-taken badgers and those from road traffic accidents are not comparable across time due to shifts in sampling, it does appear

that the prevalence of TB in badgers is generally high in areas of high herd breakdown rates (paragraphs 5.4.4, 5.4.5 and 5.4.7).

5.8.4 Repeat breakdowns in the same herd are infrequent, but have increased over the last ten years. Herds which have had two or more breakdowns are found in clusters, mainly in South-West England (paragraph 5.4.11).

5.8.5 Fertility control is likely to be less effective than culling as a strategy to reduce TB in badger populations and hence any transmission to cattle. Research in this area is not, therefore considered to be a high priority (section 5.5).

5.8.6 We recommend that the efficacy of culling should be evaluated experimentally in a minimum of 30 10km by 10km areas at highest risk of repeat or contiguous breakdowns. No culling should take place outside them. Three strategies should be compared: a reactive strategy, where following a breakdown, all social groups (including lactating sows) that had access to the breakdown herd are removed; a proactive strategy, where all badgers are removed; and a no cull strategy. The three treatments should be allocated randomly to equal numbers of areas. We estimate quantitative results would be available in five years to enable a full assessment of the extent to which culling is a cost-effective intervention strategy (section 5.6).

5.8.7 Quantitative data on recolonisation times is scant. We recommend further research on this in areas subject to the reactive and proactive strategies (paragraph 5.6.10).

5.8.8 The detailed experiment design should be overseen by an independent Expert Group. This group should finally determine the areas to be included in the experiment having carried out a further analysis of the recommended approach to test the assumptions used. It would monitor the experiment and herd breakdown patterns outside the experimental areas and should make recommendations on whether any new areas should be recruited into the experiment (paragraphs 5.6.14, 5.6.24 and 5.6.36).

5.8.9 Steps should be considered to improve the efficiency of removal operations.

- (i) Trapping may not always be the most efficient method of removal. The efficacy, cost and welfare implications of alternative methods, including stop-snaring, should be further considered (paragraph 5.6.8).
- (ii) Targets should be set and monitored to reduce delays between breakdowns and the start of removal operations (paragraph 5.6.6).
- (iii) Given the benefits of the experiment for the farming industry, further consideration should be given to what farmers themselves might contribute to operations (paragraph 5.6.37).

5.8.10 We estimate that over five years the total number of badgers killed in the experiment is unlikely to be substantially different from the number removed had the

interim strategy continued. Moreover, it is likely to be substantially less than the number killed in road accidents over the same period (paragraphs 5.6.28 to 5.6.30).

5.8.11 If badgers are the cause of a substantial number of breakdowns, we consider that husbandry could make an important contribution to tackling the problem and that the farming industry should take the lead in developing and implementing an experimental comparison of the most promising husbandry techniques. The Government should act as facilitator (paragraphs 5.7.5 and 5.7.6).

5.8.12 The Government should give further consideration to whether incentives could be linked to good practice (paragraph 5.7.7).

6 TB diagnosis and vaccines

6.1 Introduction

6.1.1 This chapter deals with TB diagnosis and vaccines and assesses strategies to identify and reduce the disease in badgers and cattle. Section 6.2 deals briefly with the pathogenesis of the disease in cattle and badgers. Section 6.3 assesses techniques for diagnosis. Section 6.4 reviews the prospects for vaccine development and section 6.5 considers other strategies for biological control of *M. bovis*. Section 6.6 summarises the conclusions and recommendations.

6.2 The disease in cattle and badgers

6.2.1 A number of features of the pathogenesis and immunology of infection with *M. bovis* have an important bearing on the use of diagnostic tests and vaccines in disease control programmes. Cattle become infected with *M. bovis* by inhalation or ingestion of the organisms, resulting in growth of the bacteria particularly in the lungs and the lymph nodes associated with the respiratory tract (Pritchard 1988; Jubb *et al.* 1993). In many animals, infection is confined to a few foci in these organs, but in a small number of cases there is extensive involvement of the lungs and spread of infection throughout the body (Francis 1958). Animals may remain infected for many months or years before showing obvious clinical signs and during this period they may intermittently excrete *M. bovis* in nasal secretions.

6.2.2 Studies of experimentally infected cattle indicate that the severity of lung pathology and the rate at which infected animals develop clinical disease are influenced by the infective dose of *M. bovis* (Neill *et al.* 1994b; Buddle *et al.* 1994). Under the current programme of herd testing, progression to clinical disease is an uncommon occurrence: post-mortem examination of infected animals identified by routine skin testing has shown that most animals have only a few foci of disease, indicating that they have been infected with a low dose of organisms and/or that they are in the early stages of the disease (McIlroy *et al.* 1986; R. Clifton-Hadley, personal communication).

6.2.3 The ability of *M. bovis* to replicate intracellularly in a subpopulation of leukocytes is an important factor in enabling the organism to establish persistent infections. Infection stimulates a strong cellular immune response which in cattle is first detectable about one month after infection (Pollock *et al.* 1996). Although this response helps to limit multiplication and spread of the organism, it may not be effective at clearing the infection and the resultant chronic immune stimulation contributes to the pathology of the disease (see Figure 6.1).

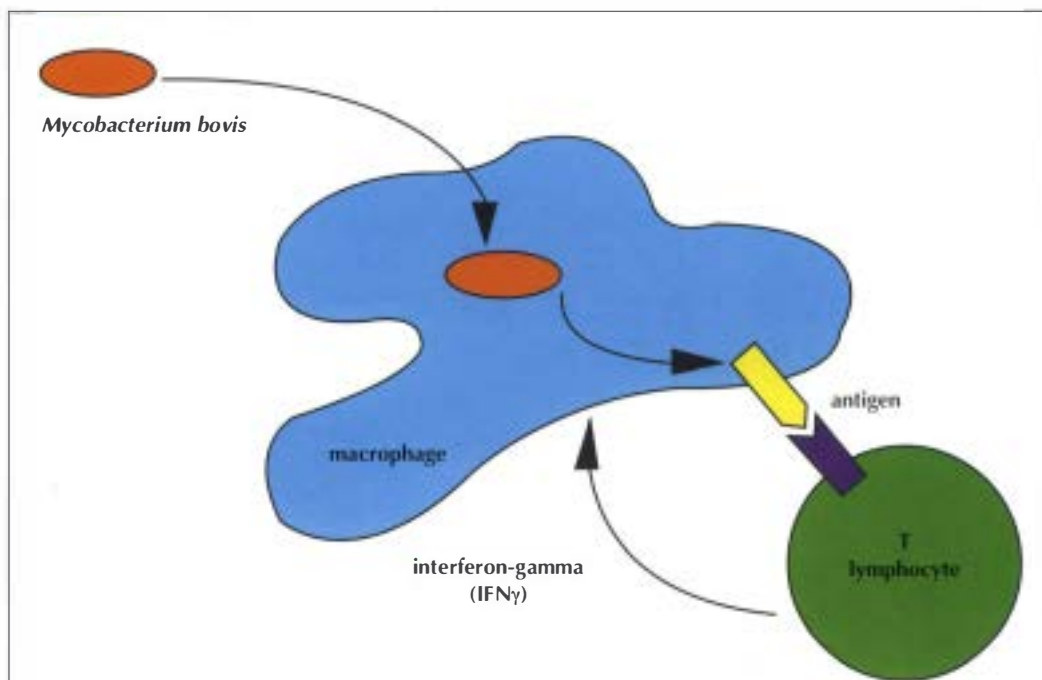

Figure 6.1 – Immunological events associated with mycobacterial infection

When pathogenic mycobacteria (*M. bovis* or *M. tuberculosis*) enter the body they are taken up by specialised cells known as macrophages. Molecular components of the bacteria, termed antigens, are presented on the surface of the infected cells. The antigens are recognised by specific T lymphocytes which then release chemical messengers instructing the macrophages to kill the bacteria. Interferon-gamma is one of the most important of these messengers.

At the same time, the T lymphocytes divide, resulting in an increase in the total number of bacteria-specific T lymphocytes in animals exposed to infection. This initial immune response may be only partially effective, leaving bacteria alive and able to cause a prolonged infection. When a large number of bacteria build up during active disease, antibodies that bind to specific mycobacterial antigens are found in the blood of infected individuals.

Two general strategies are used for immunological diagnosis of animals infected with *M. bovis*. The first involves measurement of activities of T lymphocytes. This is most commonly done in the form of a tuberculin test, which involves injection of a mixture of mycobacterial antigens into the skin. Recognition of the antigens by T lymphocytes results in localised swelling at the injection site. An alternative protocol involves stimulation of T lymphocytes by addition of antigens to blood samples. The T lymphocyte response can be detected by measurement of release of interferon-gamma.

The second diagnostic strategy is based on detection of specific antibodies in blood samples. Techniques for measuring antibodies are simpler and more versatile than those used to measure T lymphocyte responses, but are likely to be positive only at later stages of mycobacterial infection. The BROCK test, used for identification of infected badgers in the live test trial, is based on measurement of antibody responses to a major surface antigen of *M. bovis*.

6.2.4 Antibody responses to *M. bovis* in cattle are not well defined. Great variation between infected animals, both in onset and specificity, has been noted (Dowling and Schleeauf 1991; Fifis *et al.* 1994a). However, evidence suggests that antibody responses are often associated with waning of the cellular immune response and progression to severe disease, consistent with findings on human TB (Lenzini *et al.* 1977; Ritacco *et al.* 1991; and Fifis *et al.* 1994a).

6.2.5 Current understanding of the pathogenesis of TB in badgers is outlined in paragraphs 3.4.1 to 3.4.6. The course of infection has not been characterised in the same detail as in cattle. From preliminary experimental observations, it appears likely that, as in cattle, *M. bovis* infection in badgers stimulates an early cellular immune response followed by an antibody response later in infection (Thorns and Morris 1983; Nolan and Wilesmith 1994).

6.2.6 Studies of naturally infected badgers have revealed marked variation in the severity of the disease. Some infected animals localise the infection in small lesions that may provide a source for intermittent excretion of bacteria. In other animals, a more generalised infection occurs, with the potential spread of large numbers of organisms from sputum and sometimes also from urine (Little *et al.* 1982; Cheeseman *et al.* 1988b).

6.3 TB diagnosis

6.3.1 Two general strategies are available for diagnosis of mycobacterial infection. The first involves direct demonstration of the presence of the infecting organism, by microbial culture or by detection of a specific component of the bacteria (amplified DNA fragments, for example). This approach provides definitive proof of infection, but is dependent on the availability of a suitable sample of infected tissue or secretion, and is most commonly applied post-mortem (Pritchard *et al.* 1987).

6.3.2 The second strategy involves measurement of an immunological response to infection. The most sensitive tests require measurement of responses by T lymphocytes, which are the mediators of cellular immune responses (see Figure 6.1). Alternative tests involving measurement of specific antibodies in blood samples can also be used. However, since antibody responses generally develop late in the course of infection, such tests are less useful for early diagnosis (Neill *et al.* 1994b; Nolan and Wilesmith 1994; Wood and Rothel 1994; Clifton-Hadley *et al.* 1995a). In this section we review current strategies used for diagnosis of TB in cattle and badgers, and evaluate prospects for improved tests.

Cattle

Review of current procedures

6.3.3 The tuberculin skin test is the primary means of diagnosing TB in cattle. This test involves intradermal injection of a mycobacterial extract which, in infected animals, provokes a local cellular immune response causing swelling that can be detected after three days by measuring skin thickness. This extract, known as tuberculin (also referred to as purified protein derivative or PPD), contains a mixture of the major bacterial components that are recognised by the immune system. To distinguish infection with *M. bovis* from exposure to harmless environmental mycobacteria, the response to *M. bovis* extract is compared with the response to an equivalent extract from *Mycobacterium avium*. Animals responding preferentially to *M. bovis* are classed as 'reactors' and

slaughtered (Monaghan *et al.* 1994). Use of the tuberculin test and testing protocols are stipulated by EU legislation (Directive 64/432/EEC; Directive 97/12/EC also relevant).

6.3.4 The EU legislation on TB specifies the minimum frequency of herd testing. This varies from yearly to once every four years, depending on the percentage of infected herds. The criteria are applied by Member States who are responsible for defining the area to which the testing frequency applies (currently defined as a county or larger area in Great Britain) and also how the percentage of infected herds is calculated (the legislation is unclear on this point). Broadly, the legislation requires that where, over a specified reference period (four years for areas on four yearly testing; three years for areas on three yearly testing; and two years for areas on two yearly testing) the percentage of infected herds is above 0.1%, testing should move from a four yearly to three yearly cycle; where it rises above 0.2% it would move to a two yearly cycle; and where it rises above 1% it would move to an annual cycle.

6.3.5 In herds with no recent history of infection, a 'standard interpretation' of the tuberculin test is applied. Animals are classified as reactors if the skin reaction to *M. bovis* is more than 4mm greater than the reaction to *M. avium*. Animals with a skin reaction to *M. bovis* up to 4mm greater than the reaction to *M. avium* are considered inconclusive and are re-tested.

6.3.6 A 'severe interpretation' of the test is applied retrospectively to herd test results in most cases where a reactor has been confirmed (by the presence of visible lesions or the culture of *M. bovis*). It is also applied in follow-up testing of herds in which a breakdown has been confirmed. Under this interpretation, animals with a swelling of more than 2mm greater than that obtained with the avian antigen are classified as reactors (Lesslie and Herbert 1975).

6.3.7 Herds in which a breakdown occurs are re-tested at 60 day intervals until they have two consecutive clear tests, after which they are tested again, six and 12 months later. The interval of 60 days between tests is required because tuberculin testing of infected animals has been shown to result in non-responsiveness to re-testing for a period of several weeks (Radunz and Lepper 1985). This period also allows animals incubating the infection to become positive. Affected herds are placed under movement restrictions so that no cattle can move onto or off the premises except under licence issued by MAFF. In most cases, it is this restriction on movement of animals rather than the loss of reactor animals that has the greatest economic impact on affected herds.

6.3.8 Routine inspection of carcasses in slaughterhouses represents an additional means of surveillance for TB in the cattle population. The procedure includes visual screening for evidence of lymph node enlargement, palpation of viscera and examination of cut slices of lymph nodes for the appearance of granulomatous lesions characteristic of TB. Between 12 and 42 infected carcasses (other than reactors) have been detected annually

over the last six years in slaughterhouses in Great Britain. This compares with between 180 and 471 confirmed herd breakdowns a year over the same period.

6.3.9 Larger numbers of infected carcasses are detected in Northern Ireland and the animal identification scheme there is used routinely to trace the herds of origin for follow-up testing. Currently 20-30% of the new confirmed herd breakdowns in Northern Ireland are detected in this way. By contrast, the total number of infected carcasses detected each year in slaughterhouses in Great Britain, expressed as a percentage of confirmed herd breakdowns, is between 5% and 9%. The reasons for this difference are not clear.

6.3.10 The numbers of infected animals detected by inspection of carcasses are almost certainly an underestimate of the true incidence. For example, it would not be possible to detect animals with lesions that are invisible to the naked eye, and a proportion of animals that have only one or two small lesions are likely to be missed by routine slaughter checks. However, such animals would be of low infectivity.

6.3.11 Identification of infected carcasses in slaughterhouses does not necessarily reflect a failure of the tuberculin test to detect the infection: given that infected cattle can develop grossly visible lesions within one month of infection with *M. bovis*, it would be expected that some animals will become infected and be presented for slaughter in the intervals between herd tests. Moreover, some animals (e.g. from fatstock herds) will not have been tested. The computerised animal identification scheme, once it is in place, should provide a more reliable means of tracing back to determine the source of infection and hence possibly identifying additional infected herds in the intervals between routine herd testing.

6.3.12 Two criteria are crucial in determining the effectiveness of the tuberculin test: its ability correctly to identify

- (i) infected cattle (sensitivity); and
- (ii) uninfected cattle (specificity).

6.3.13 Studies of the *sensitivity* of the tuberculin test, defined as the percentage of infected animals correctly identified, report a range of values from 77% to 95%, based on standard interpretation of the test (Monaghan *et al.* 1994). Given that many infected herds contain only one or two infected animals, it is possible that infection goes undetected in a small number of cases. However, in herds where infection is detected, the follow-up herd testing procedures, which involve repeat testing until negative and application of the severe interpretation of the test, should ensure that few infected animals remain undetected. Repeated breakdowns might be expected in affected herds if the testing procedure failed to detect all infected animals. These have increased in frequency from 9.8% of affected herds, for the period 1987 to 1991, to 16.5%, for the period 1992 to 1996. However, they remain infrequent: over the ten years 1987 to 1996

the majority, 85%, of affected herds suffered only one breakdown. Routine inspection of carcasses at slaughterhouses also detects few confirmed *M. bovis* infections.

6.3.14 Absence of skin test reactivity is associated with two stages of mycobacterial disease. Animals are likely to be negative for the first month or so after infection and may also become negative in advanced stages of disease when large numbers of bacteria are present in tissues (Francis 1958; Plackett *et al.* 1989). Repeat testing should detect the former category of animal. Animals with advanced infections will eventually show clinical disease and would be expected to be most active in transmitting infection to in-contact animals. However, clinical TB in cattle is now extremely rare (Neill *et al.* 1992; Neill *et al.* 1994b; Griffin and Dolan 1995). Moreover, the majority of herd breakdowns involve only one or two animals. Post-mortem examination usually reveals only a few tuberculous lesions in the lungs, indicating that they are in the early stages of the disease or have been infected with a small number of organisms. These features of the disease in cattle argue against the existence of a significant residual population of infected cattle that escape detection by the tuberculin test and act as a source of continued transmission. They are consistent with a source of infection external to the herd itself.

6.3.15 The *specificity* of the tuberculin test, defined as the percentage of truly negative animals correctly identified using the standard interpretation of the test, is greater than 99% (Wilesmith and Williams 1987; Wood and Rothel 1994). This figure is based on the absence of positive reactions in populations of cattle known to be free of infection. There is a perception among some farming groups that the tuberculin test gives an unsatisfactory level of false positive reactions. Although only 40-50% of all reactor animals have obviously visible lesions at slaughter, in Northern Ireland, more detailed post-mortem examination of a small number of reactor animals, identified by standard interpretation of the tuberculin test, detected infection in 85% of animals (McIlroy *et al.* 1986). In addition, of 2,308,345 cattle tested in 1996, there were 3,456 reactors, of which 78.4% were from confirmed breakdowns. Of the total animals tested, 696 (0.03%) were killed as reactors without subsequent confirmation of the herd breakdown and 52 reactors are still under investigation (R. Clifton-Hadley, personal communication). These findings, when considered in relation to the total numbers of animals that are tested for TB, indicate a very low incidence of false positive reactions.

Prospects for improved tests

6.3.16 Strategies for development of improved diagnostic tests include the use of better defined antigen preparations, and the use of alternative methods to measure immune responses. Efforts have been made to identify individual *M. bovis* molecules that would form the basis of more specific tests for detection of infection. In general, gains in specificity using defined antigens have been offset by losses in sensitivity. Only a subset of animals respond to any one antigen (Fifis *et al.* 1992; Fifis *et al.* 1994b).

6.3.17 Gene cloning techniques provide important new tools in this area. Screening of individual bacterial proteins expressed by cloned *M. bovis* genes for immune recognition by infected animals offers a means of identifying antigens of potential use for diagnosis (Hewinson *et al.* 1995). Particular attention has been given to the study of proteins that are secreted from the actively-growing bacteria. These include two related proteins, known as MPB70 (Radford *et al.* 1990) and MPB83 (Harboe *et al.* 1995; Hewinson *et al.* 1996; Matsuo *et al.* 1996) that are expressed at high levels by *M. bovis* but at relatively low levels by *M. tuberculosis* (Wiker *et al.* 1996); and two proteins, ESAT6 and MPB64, that are absent from the *M. bovis* strain used in the BCG vaccine (Mahairas *et al.* 1996; Harboe *et al.* 1996). A cocktail of such antigens that collectively are recognised by all infected animals could substitute for tuberculin.

6.3.18 As an alternative to the skin test, cellular immune responses to *M. bovis* can be assayed *in vitro* by culturing blood lymphocytes with *M. bovis* antigen for several days and measuring proliferation of T lymphocytes or soluble products (cytokines) of the proliferating cells (Griffin *et al.* 1991; Wood and Rothel 1994). A version of this assay, involving culture of whole blood with *M. bovis* antigen and measurement of interferon-gamma production after 16 to 24 hours, has been developed in Australia (Wood *et al.* 1990). A large field trial in which this assay was tested in 6,000 cattle from a TB-free area and over 6,000 animals from herds known to be infected with *M. bovis* in Australia gave sensitivity and specificity values of 93.6% and 96.3% respectively (Wood *et al.* 1991).

6.3.19 Two detailed comparisons of the interferon-gamma assay with the tuberculin test have been conducted in Northern Ireland, involving over 100,000 animals (Neill *et al.* 1994a; S.D. Neill, personal communication). Absolute values for sensitivity and specificity could not be determined because only a selected population of tuberculin negative animals could be examined at slaughter. Based on those animals that were available for slaughter, the two tests compared favourably for sensitivity: they identified a similar number of animals with disease, although the populations identified by each test were not identical, i.e. some diseased animals were tuberculin negative but positive in the interferon-gamma test and vice versa. The number of animals which tested as positive with the interferon-gamma assay was far greater than the number which tested as positive with the tuberculin test. We consider it likely that some of these were false positives, but the precise proportion could not be determined.

6.3.20 Because of the inferior specificity of the interferon-gamma test in its present form, it would not be acceptable on economic grounds as a substitute for the tuberculin test. However, it could prove useful for retesting of herds in which a reactor has been identified by tuberculin testing. The identification of component antigens of *M. bovis* that can be used for diagnosis may enable the specificity of the test to be improved. Although such a test requires access to laboratory cell culture facilities, it would have

the advantage of requiring only a single farm visit for each herd test, giving substantial financial savings.

6.3.21 Use of defined antigens and alternative immunological measurements may allow the development of diagnostic tests for bovine TB that offer improvements in terms of sensitivity, specificity and quality control. The use of alternative tests may also result in reduction in cost of the testing programme. However, we conclude that it is unlikely that improved tests will lead directly to a radical alteration in prospects or strategies for control of TB in cattle based on identification and removal of infected animals.

Considerations related to vaccines

6.3.22 If vaccines are to be used for control of TB in cattle or badgers, it will be essential to develop diagnostic tests that distinguish infection from vaccination. As outlined below in section 6.4, two approaches are being pursued for vaccine development. One approach makes use of a living bacterium that is genetically disabled in a way that destroys its ability to cause disease. In this case, an appropriate diagnostic test would measure the immune response to an antigen that is present in virulent *M. bovis*, but absent from the vaccine. Preliminary experiments suggest that the ESAT6 antigen detects an immune response in cattle infected with *M. bovis*, but not in those vaccinated with BCG, for example (Pollock and Anderson 1997a, b).

6.3.23 The alternative vaccine strategy is based on induction of immune responses to a small number of defined antigens. A diagnostic test in this case, could involve specific removal of the vaccine antigens from the tuberculin testing reagent. Genetic techniques to accomplish this have recently been developed for mycobacteria.

Badgers

Review of existing tests

6.3.24 There are two current applications of diagnostic tests for *M. bovis* in badgers:

- (i) screening of badger carcasses collected from road traffic accidents or from MAFF clearance operations; and
- (ii) identification of infection in live trapped animals for selective removal operations.

Pathological examination and microbiological culture of post-mortem samples are used to screen badger carcasses. These techniques are labour intensive and not all infected animals are detected because some lesions would be too small to be visible to the naked eye. Use of the tuberculin test to detect infection in live badgers is not practicable because of the need to re-examine the animals after three days and the fact that badgers give a poor response to the tuberculin test (Little *et al.* 1982).

6.3.25 A serological test, the BROCK test (also called the 'live test'), which detects *M. bovis*-specific antibody, has been developed for rapid screening of live animals

(Goodger *et al.* 1994a). This test is based on measurement of antibody responses to an antigen preparation composed predominantly of MPB83, a glycosylated lipoprotein (Harboe *et al.* 1995; Hewinson *et al.* 1996; Matsuo *et al.* 1996) identified as a major target of the antibody response in infected badgers (Goodger *et al.* 1994b). However, the overall sensitivity of this test is relatively low: only about 40% of badgers with post-mortem evidence of infection test positive with the BROCK test (Clifton-Hadley *et al.* 1995a).

6.3.26 A strategy for reducing *M. bovis* infection in badgers, based on culling only setts containing animals positive in the BROCK test, was developed and evaluation started in the live test trial. However, analysis of the preliminary results from the trial (see paragraph 5.3.8) showed that the prevalence of TB in badgers culled on the basis of BROCK test positivity was not significantly higher than that in badgers culled under the interim strategy in the 'no live test' control areas (37.5% versus 34.1% see also Table 5.2). Both the insensitivity of the diagnostic test and the limited efficiency of badger trapping have contributed to this lack of success (see Appendix 15).

Alternative diagnostic strategies

6.3.27 Measurement of T cell responses could provide a more sensitive diagnostic test for TB in badgers. Skin testing is impractical because of the need to handle animals twice at an interval of three days. An alternative approach would be blood-based tests, such as the interferon-gamma assay, which would require sampling on only one occasion. The minimum requirement of 24 hours to obtain a result would make it difficult to implement in field programmes aimed at identifying and removing infected animals. However, such a test would be of value in disease surveillance programmes involving capture and release of live animals, e.g. to determine the impact of a field vaccine trial.

6.3.28 Detection of *M. bovis* in the environment of setts, or latrines, represents an alternative strategy to monitor local levels of infection. Previous experience using microbiological techniques to monitor *M. bovis* in samples of badger faeces have proved disappointing (Cheeseman *et al.* 1988b). However, we recommend that it may be worthwhile to re-examine this topic using modern DNA amplification techniques – such as the polymerase chain reaction (PCR) – in place of microbial culture. PCR is a very sensitive technique that allows detection of small amounts of a particular fragment of DNA – in this case, a fragment specific for *M. bovis*. Using suitable extraction techniques, it may be possible to detect DNA in environmental samples. It has the advantage over microbiological culture of being more rapid, and being able to detect the remnants of dead bacteria in addition to living organisms.

6.3.29 Such a test, if sufficiently sensitive, might also be of value for rapid screening of samples from badger carcasses. We estimate that existing assays could be optimised for this purpose within one to two years. We recommend that MAFF should consider whether this might be a useful and safer alternative to microbiological examination.

6.4 Vaccines

6.4.1 The outcome of infection with pathogenic mycobacteria is critically dependent on the immune response of the host, and vaccination presents an attractive strategy for control of mycobacterial disease. A vaccine against human TB – Bacille Calmette Guerin (BCG), an attenuated strain of *M. bovis* – was first used in 1921, and is currently widely administered as part of the World Health Organisation Expanded Programme for Immunisation. A series of clinical trials have shown that BCG protects against primary, childhood TB, but has variable efficacy against the predominant pulmonary form of the disease in adults (Fine and Rodrigues 1990; Besnard *et al.* 1993).

6.4.2 There is currently a resurgence of interest in development of improved vaccines to combat human TB (Malin and Young 1996). This has been driven by an increasing public health problem, particularly related to the emergence of drug-resistant organisms, and by new opportunities provided by advances in mycobacterial molecular genetics. Against this background, it is important to consider the prospects for use of vaccination in control of the bovine TB problem to increase the resistance of cattle to TB infection, and/or to reduce TB in badgers.

Strategies for vaccine development

6.4.3 The veterinary use of TB vaccines was reviewed by a WHO/FAO/OIE consultation group in 1994. The report identified two classes of vaccine candidate. The first class includes vaccines for which efficacy has been demonstrated in laboratory models of infection, and which could be evaluated in the target host species within a time-frame of four to six years. The second class of vaccines are those currently under laboratory development, that may become available in the longer term (15 years).

6.4.4 Vaccine candidates currently available for testing include BCG, crude antigenic derivatives of *M. bovis* (such as short term culture filtrate), and environmental mycobacterial species.

6.4.5 A series of BCG trials have been conducted in cattle and have recorded varying degrees of protection against *M. bovis* challenge (O'Reilly and Daborn 1995). A recent study in New Zealand examined the effect of vaccination of cattle with low doses of BCG (1,000-1,000,000 organisms) (Buddle *et al.* 1995a, c). This dose was selected on the basis of results indicating that it was more effective than high dose vaccination in induction of the type of immune response thought to mediate protection against TB (Bretscher 1992, Buddle *et al.* 1995b). Vaccination resulted in a significant reduction in the number of animals with lung lesions after subsequent challenge with virulent *M. bovis*. However, protection was only partial, with *M. bovis* being cultured from tissues of 11 of 27 vaccinated animals.

6.4.6 The presence of persistent infection in vaccinated animals would not be acceptable in a cattle vaccine. BCG, administered by this protocol, would therefore seem to have

limited application. Subsequent studies suggest that the efficacy of BCG in cattle is further compromised by prior exposure to environmental mycobacteria (Buddle *et al.* 1995a).

6.4.7 There has been very limited analysis of the efficacy of BCG in badgers. One pilot study showed some reduction in pathology, but the number of animals was insufficient to allow reliable assessment (Stuart *et al.* 1988).

6.4.8 Recent studies have shown that vaccination with mycobacterial culture filtrate preparations can confer protection against challenge with *M. tuberculosis* in mouse and guinea pig models (Andersen 1994; Pal and Horwitz 1992). Experimental vaccine trials in cattle are currently underway in New Zealand, using similar preparations of *M. bovis* culture filtrate (Buddle *et al.* 1995a).

6.4.9 Vaccination with a heat-killed environmental mycobacterium – *M. vaccae* – is currently being evaluated for immunotherapeutic potential against human TB (Stanford *et al.* 1990). Preliminary trials of this vaccine in cattle (Buddle *et al.* 1995c), and pilot studies in badgers (Stuart *et al.* 1988), provided no evidence of protection against *M. bovis* challenge.

A better BCG

The most successful mycobacterial vaccine to date has been the bacterium of Calmette and Guerin – BCG. This is a strain of *M. bovis* originally isolated from an infected cow. During 13 years of culture in the laboratory, it lost its ability to cause disease, but retained, at least in part, its ability to induce an immune response. We now know that the loss of virulence was associated with deletion of large sections of the genome – some strains of BCG have lost as much as 30 thousand base pairs of DNA.

Using recently developed molecular genetic tools for mycobacteria, it is now possible to precisely inactivate, or remove, individual genes. Approaches based on removal of carefully selected genes have been successfully exploited to develop improved vaccines for other bacterial pathogens (salmonella and cholera, for example), and hold considerable promise for mycobacterial vaccines. The experimental strategy involves conversion of a virulent strain of *M. bovis* to a non-pathogenic vaccine strain by removal of genes that are required to cause disease.

A vaccine produced by this route would be classed as a genetically modified organism, or GMO. Strict regulations apply to the use of such organisms outside of the laboratory. A variety of safeguards have to be built into the vaccine strain, including deletion of multiple genes (to ensure that there is no possibility of a return to virulence), and manipulation of its ability to survive in the vaccinated animal and in the environment.

Other researchers are trying to improve the BCG vaccine itself. One new strain of BCG expresses interferon-gamma, for example, with the aim of inducing an enhanced immune response. Another strain of BCG has been engineered to reduce its ability to survive in individuals with immune defects, in order to allow safe use in AIDS patients (Guleria *et al.* 1996).

6.4.10 In the longer term, two general strategies are being used to generate new vaccine candidates. The first, based on the BCG paradigm, involves use of live attenuated mycobacterial strains. Such strains can be constructed by inactivation, or deletion, of *M. bovis* genes that encode molecules essential for the disease process. This approach has been used to generate new vaccines for other bacterial diseases – typhoid and cholera, for example – that are currently undergoing clinical evaluation (Levine *et al.* 1997). This strategy would eventually involve release of genetically

manipulated organisms into the environment, and questions of stability and safety are clearly of paramount importance.

6.4.11 The second strategy is based on the induction of immune responses to component antigens of *M. bovis* delivered in the form of a subunit vaccine. Such a subunit vaccine might take three forms:

- (i) purified antigens incorporated into an adjuvant (i.e. a compound that enhances the immune response);
- (ii) expression of the antigens as recombinant products in another attenuated bacterial or viral 'vaccine vector' (an example of this approach is a recombinant virus related to the smallpox vaccine that has been used successfully to vaccinate foxes against rabies in parts of Europe (Brochier *et al.* 1995)); or
- (iii) the direct administration of the genes encoding the relevant *M. bovis* antigens in the form of a 'DNA vaccine' (Tang *et al.* 1992).

Subunit vaccines

An alternative strategy for vaccine development is based on the approach of inducing immune responses to key selected mycobacterial antigens, using a subunit vaccine. Promising results have been achieved in mouse and guinea pig models using subunit vaccines comprising proteins that are secreted from pathogenic mycobacteria during growth. The crude antigen mixtures are now being further characterised, and the most active components produced in bulk using recombinant DNA technology.

A range of experimental procedures are being tested in order to identify the best way to deliver subunit vaccines. The purified antigens can be directly mixed with compounds (adjuvants) designed to enhance the immune response. Alternatively, the mycobacterial gene encoding the antigen can be incorporated into the genome of some other vaccine – a modification of the smallpox vaccine, for example – where it is expressed as a recombinant molecule.

Some of the most exciting recent effects have been observed when mycobacterial genes are delivered in the form of DNA vaccines. In this novel procedure, genes encoding selected antigens are directly injected into tissues of the experimental animal, where they are expressed in a form that triggers an immune response. Several mycobacterial genes have been shown to confer protection against challenge with *M. tuberculosis* following delivery as DNA vaccines (Huygen *et al.* 1996; Tascon *et al.* 1996).

Subunit vaccines have significant advantages over live bacterial vaccines from the point of view of regulatory considerations related to safety and quality control. To ensure that it is effective in a wide range of individuals, a subunit vaccine will have to include multiple genes or antigens. Attention will also have to be given to the possible selection of variant strains of mycobacteria that may have dispensed with the genes encoding the target antigens.

6.4.12 A potential concern relating to the use of a subunit vaccine is the possibility that vaccination will result in selection of strains of *M. bovis* that develop resistance to the vaccine. Such organisms might arise as a result of mutations affecting the gene encoding the antigen used for vaccination. The use of multiple antigens, or antigens encoded by essential genes, should avoid this problem.

6.4.13 As discussed above, the development of a test to distinguish infected from vaccinated animals is an essential component of any vaccine development programme.

This is likely to be simpler in the case of a subunit vaccine than in the case of a live attenuated vaccine.

Co-ordination with human vaccine development programmes

6.4.14 Despite clear differences between *M. bovis* and *M. tuberculosis* in their ability to produce disease in different host species (Francis 1958), the two organisms have similar biological properties and induce a similar spectrum of immune responses. Therefore, it is likely that related molecules are involved in determining virulence and in induction of immunity. The initial stages of development of a vaccine for cattle or badgers are also closely related to those involved in preclinical development of human TB vaccines. It is essential that there should be proper co-ordination between these programmes to address fundamental questions related to mycobacterial vaccine development. We recommend that MAFF should give further consideration to how this might most effectively be achieved, including through the involvement of independent experts.

Profile of an effective cattle vaccine

6.4.15 Use of a vaccine to control TB in cattle is effectively ruled out by the current EU legislation, because it would compromise the existing skin testing system. An effective diagnostic test capable of differentiating infection from vaccination would therefore be essential. It may also be appropriate to engineer the vaccine to include some form of molecular 'tag' (an additional antigen absent from natural *M. bovis* for example) to allow the positive identification of vaccinated animals. Introduction of the national animal identification scheme, which will facilitate monitoring of the history of individual animals, could also provide circumstances more favourable to introduction of a TB vaccine for selected cattle populations at risk of infection.

6.4.16 In contrast to a badger vaccine, a cattle vaccine would have to protect animals against establishment of persistent infection: a reduction of the bacterial load in infected animals would not be an acceptable outcome.

6.4.17 Assuming that the majority of herd breakdowns are not due to cattle-to-cattle transmission, cattle vaccination would not eradicate the risk of disease. However, it could reduce the risk of herd breakdowns and hence result in a lower frequency of testing. The efficacy required of a cattle vaccine depends on the risk of infection, which currently varies in different regions of the country and is reflected in the herd breakdown rate and the herd testing intervals. By applying a simple mathematical model, which assumes that the number of reactors in each breakdown herd is about one and that all animals are vaccinated, it is predicted that, in regions currently subjected to annual testing, a vaccine efficacy of over 90% would be required to reduce the testing interval to four years. However, if used in conjunction with other control methods that lower the risk of infection (e.g. reduction of infection in badgers), a vaccine of lower efficacy could achieve the same results.

6.4.18 Delivery of a cattle vaccine could be considerably easier than in the case of badgers. A range of potential delivery systems, including injection, would be available. If regulatory approval were considered likely, it is possible that pharmaceutical companies would be interested in development and marketing of a cattle vaccine.

6.4.19 There would be little short-term financial benefit in vaccination of cattle as a control strategy, because of the need to continue intensive herd testing in the target populations. However, in the longer term, if a vaccine proved effective in reducing herd breakdowns, there could be significant savings. The extent of the savings would depend on whether the cost of vaccination was borne by the farmer or by Government. A full cost-benefit analysis would be necessary once the properties of an effective vaccine are known.

Development and testing of vaccine candidates

6.4.20 The development of a vaccine for cattle has not been a high priority in the research programme on *M. bovis* in the UK. However, as outlined above, advances in the molecular genetics of mycobacterial organisms together with the emergence of new vaccine delivery systems, has created opportunities for vaccine development. Internationally, the research effort in this area is limited because only in a few countries is the herd breakdown rate sufficiently high to cause concern. One such country, New Zealand, where the principal wildlife reservoir of infection is believed to be the possum, has an active research programme on vaccine development for cattle and is now also actively considering a possum vaccine. An effective cattle vaccine could have significant public health and trade benefits for many developing countries.

6.4.21 Both the identification of new candidate antigens and the progression from initial screening of vaccines to testing in the target species would be significantly easier for a cattle vaccine than in the case of a badger vaccine. Experimental challenge systems have been described in cattle, for example, and considerably more background information and immunological reagents are available for studying responses to a vaccine in cattle as compared with badgers. The availability of experimental models of the disease and of immunisation (BCG) in the natural host is of major advantage for studies of immune responses to *M. bovis* aimed at identification of new candidate antigens for vaccination and for use in diagnostic tests. Similarly, field evaluation of vaccine efficacy and safety presents significantly fewer obstacles than is the case for a badger vaccine.

6.4.22 The development of a vaccine can be considered in three phases.

- (i) Candidate vaccines are generated and tested in laboratory models (such as mice and guinea pigs).
- (ii) Promising candidates are evaluated in experimental challenge studies in the target host to establish appropriate vaccination protocols (dose, route of immunisation, etc.).

- (iii) Field trials are carried out to determine the efficacy and safety under operational conditions.

The precise timescale for research of this nature is difficult to predict, but we estimate that each of these phases would last about five years. We recommend there should be a formal review of progress after five years.

6.4.23 Elements of the initial phase of laboratory-based research will be similar whether the eventual vaccine is targeted towards cattle, badgers, or humans. However, this phase should also include studies of the immune responses of cattle to *M. bovis* with the aim of identifying antigens that may have particular utility for vaccination or diagnosis in this species. Progress to the later stages depends upon the successful generation of promising candidates. Effective liaison between those responsible for the initial laboratory phase and those responsible for the later stages will be essential to ensure the logistical requirements of implementation are fully taken into account in the early stages. We recommend that MAFF should consider how best to ensure this programme is effectively co-ordinated.

6.4.24 We recommend there should also be studies to develop better epidemiological models that can be used to evaluate the level of protection required of a vaccine to obtain significant financial and other benefits.

6.4.25 Legal and trade implications of cattle vaccination would have to be addressed at an early stage, bearing in mind that bovine TB is not a uniquely British problem.

Profile of an effective badger vaccine

6.4.26 The novel research opportunities described above for development of a cattle vaccine can also be applied in the case of a vaccine for control of TB in badgers. Vaccination of badgers in order to reduce the number and infectiousness of badgers with active TB is in two ways a more attractive option than cattle vaccination.

6.4.27 Firstly, not all the badgers at risk of infection would have to be vaccinated in order to achieve a large decrease in prevalence. This is due to 'herd immunity', where unvaccinated animals are indirectly protected due to the lower risk of infection in a population with vaccinated animals. This is in contrast to the situation in cattle, where (assuming that infection is from an external source) vaccination of a proportion of the animals in a herd will not reduce the risk of exposure to infection in the remaining susceptible animals.

6.4.28 Secondly, a reduction in the number and/or infectiousness of badgers infected with *M. bovis* could be achieved by a vaccine which reduced the risk of progressing to active, infectious disease and/or which decreased the number of organisms excreted in active disease. Thus, in contrast to the requirements for a cattle vaccine, a badger vaccine may be effective even if vaccinated animals continued to harbour a low level of persistent infection.

6.4.29 In addition, combined use of badger vaccines and other interventions such as cattle vaccination and husbandry practices may act synergistically to reduce the herd breakdown rate. However, due to the chance of immigration of infected badgers and other wildlife reservoirs of *M. bovis*, badger populations would have to be vaccinated frequently, especially if the effects of the vaccine were short-lived. The practical and financial implications of repeated vaccinations would need to be considered.

6.4.30 Delivery of a badger vaccine presents a major challenge. Oral baiting provides a potential approach for vaccine delivery, but would require development of a vaccine that is effective when delivered by the oral route. Two bait trials carried out in Ireland using biomarkers have demonstrated uptake by 60% and 81% of badger population (McCarthy 1993; Hughes *et al.* 1996). Efficient uptake requires careful positioning of bait close to setts, however, as badgers have been shown to ignore feeders placed outside of their usual foraging areas.

6.4.31 It is unlikely that a vaccine could be delivered to cubs prior to weaning. At the time of vaccination, it can be anticipated that a proportion of badgers may already have been exposed to *M. bovis*, and potentially harbouring a progressive infection. In such cases, an effective vaccine would have to confer 'post-exposure' protection. Additional immunological problems have to be addressed in development of a vaccine that can function under these conditions, although it should be noted that post-exposure vaccination is currently under active consideration in relation to human TB.

6.4.32 If a vaccine delivered orally in baits could achieve a 70-80% coverage but gave only 50% protection against infection, then the overall impact of the vaccine on the basic reproductive rate of the disease would be only 35-40%. This would make it unlikely that such a vaccine could eliminate the infection. Given the low chance of elimination of the disease, a decrease in the number of infectious badgers is a more realistic goal. However, the relationship between the number of infectious animals and the herd breakdown rate is not known. If this relationship is less than linear, dramatic reductions in the number of infectious badgers would be required to have a significant impact on the herd breakdown rate.

6.4.33 The potential role of oral vaccination of wildlife in disease control, has been demonstrated in the case of rabies, with vaccine uptake rates as low as 50% proving effective. The vaccine used in this case was a recombinant virus related to the smallpox vaccine, expressing a major antigen of the rabies virus. However, differences in the target species (foxes as opposed to badgers), in the time course of the disease and pattern of transmission of the infectious agent, and in the immunological mechanisms of protection, underline a need for caution in comparing the two disease situations.

Development and testing of badger vaccine candidates

6.4.34 As in the case of a cattle vaccine, initial screening of vaccine candidates can be done in well established mouse and guinea pig models, but promising candidates must then be evaluated in the target host. At the present time, experimental systems for vaccine evaluation in badgers are not available. Pursuit of this work will require susceptible badgers for experimental studies, and containment facilities suitable for work on *M. bovis* infected badgers. Only one very preliminary experimental study has documented attempts to test vaccination of badgers against TB (Stuart *et al.* 1988), and the reagents required to measure immune responses in badgers (for detection of interferon-gamma, for example) have yet to be developed. Further work will be required to assess the feasibility of badger vaccination.

6.4.35 The field testing of a badger vaccine also presents a number of difficulties. Possible parameters to be used in judging trial outcome include:

- (i) rates of infection and bacterial excretion in badgers; and
- (ii) breakdown rates in adjacent cattle herds.

Given the shortcomings of current diagnostic procedures in detecting infection in live badgers and the low incidence and sporadic nature of cattle herd breakdowns, these measurements may be insufficiently sensitive to provide meaningful results, and monitoring the effects of badger vaccination would depend on improvements in diagnostic tests, as discussed above. The possibility of exposure of cattle to the badger vaccine would have to be considered, particularly in the case of a live vaccine. Use of a badger vaccine would also therefore require development of a diagnostic test that distinguishes infection with *M. bovis* from vaccination in cattle.

Vaccines for cattle and badgers

6.4.36 Four important points have to be considered in comparing TB control strategies based on vaccination of cattle or of badgers.

- (i) The requirement for an effective badger vaccine (reduction of bacterial excretion) is less demanding than that for an effective cattle vaccine (prevention of persistent infection).
- (ii) Delivery of a badger vaccine presents a series of problems that are not encountered in the case of a cattle vaccine.
- (iii) Experimental systems are currently available for development and testing of a cattle vaccine; comparable systems have yet to be developed for badgers.
- (iv) A badger vaccine would be ineffective in controlling transmission of TB to cattle from any additional, as yet unidentified, wildlife sources.

On balance, we consider that development of a cattle vaccine currently represents a more feasible goal. We recommend that this should have a high priority along with the

pursuit of the necessary associated diagnostic test. This is a long-term policy and the outcome is uncertain. It must also be recognised that achieving the timetable set out in paragraph 6.4.22 will require considerably more resources for vaccine research than the £0.4 million a year currently spent by MAFF.

6.4.37 Candidate vaccines developed for cattle may also have efficacy in the badger. Much of the work done in the first stages of developing a cattle vaccine would be applicable to a badger vaccine. A decision on which route to follow would probably not need to be made until the second phase of the development programme outlined in paragraph 6.4.22 above. Therefore, it is important that some work essential to the development of a badger vaccine is pursued in parallel with the cattle vaccine work.

6.4.38 The legal bar to using wild-caught badgers for experiments is a significant impediment to vaccine testing in badgers. We consider that means should be sought to develop an experimental model of infection in the badger and to put in place the necessary immunological assays and diagnostic tests so that, in the longer term, selected vaccines, possibly including BCG, could be tested in the badger. This will ensure that the possibility of a badger vaccine is held open for consideration when progress on vaccination is reviewed.

6.5 Biological control

6.5.1 Strategies for control of human TB are based on prevention of disease by vaccination, or reduction of transmission by treatment of infectious cases. It would theoretically be possible to cure infected animals using the same drugs that are used to treat human TB. This treatment requires careful administration of multiple drugs over a prolonged period. The problem is that incomplete therapy would actively promote the development of drug-resistant *M. bovis*. This would be a major public health hazard and means that treatment of the disease in cattle or badgers has not been considered an acceptable option. However, treatment procedures distinct from those used in man are worth further investigation.

6.5.2 One possible approach would be to develop techniques for reducing TB infection in badgers through biological control using bacteriophages^a to destroy *M. bovis* in the environment. Two potential difficulties which would need to be evaluated in the early stages are:

- (i) the ease with which *M. bovis* would evolve resistance; and
- (ii) the need to identify robust bacteriophages that could survive in the environment.

We recommend that further consideration should be given to evaluating the prospects for the development of successful techniques in this area.

^a 'Bacteriophages' are naturally occurring viruses that specifically infect bacteria.

6.6 Conclusions and recommendations

6.6.1 Use of defined antigens and alternative immunological measurements may allow the development of diagnostic tests for bovine TB that offer improvements in terms of sensitivity, specificity and quality control. The use of alternative tests may also result in reduction in cost of the testing programme. However, it is unlikely that improved tests will lead directly to a radical alteration in prospects or strategies for control of TB in cattle based on identification and removal of infected animals (paragraph 6.3.21).

6.6.2 PCR-based approaches involving detection of *M. bovis*, both in environmental samples from badger setts and as a possible alternative to microbiological examination of badger carcasses merit further evaluation (paragraphs 6.3.28 and 6.3.29).

6.6.3 Application of new techniques in mycobacterial genetics offer exciting opportunities for development of novel live attenuated and subunit vaccine candidates that may assist in control of TB in cattle (section 6.4).

6.6.4 Development of a cattle vaccine currently appears more feasible than a badger vaccine given, among other things, the availability of different delivery systems and experimental models to develop and test a vaccine. We recommend this research should have a high priority, while recognising it is long-term and the outcome uncertain. Legal and trade implications would have to be addressed at an early stage (paragraphs 6.4.25 and 6.4.36).

6.6.5 Any cattle vaccination programme would require a diagnostic test capable of differentiating between infected, including cattle infected following vaccination, and vaccinated animals. This test should be developed in parallel with the vaccine work. It may also be appropriate to engineer the vaccine to include some form of molecular 'tag' to allow positive identification of vaccinated animals (paragraphs 6.4.15 and 6.4.36).

6.6.6 A cattle vaccine would require a higher efficacy than a badger vaccine and would have to protect against the establishment of persistent infection; but a lower vaccine efficacy might be effective if it were used in conjunction with other measures that lowered the risk of infection (paragraphs 6.4.16 and 6.4.17).

6.6.7 Vaccine development would fall into three phases, each of about five years. Achieving this timetable will require considerably more resources for vaccine research than the £0.4 million a year currently spent by MAFF. Progress should, in any event, be formally evaluated after five years (paragraphs 6.4.22 and 6.4.36).

6.6.8 Much of the first phase work for a cattle vaccine would be applicable to a badger vaccine: a decision on which route (either or both) to follow would probably need to be taken in the second phase of the development programme outlined in paragraph 6.4.22. The first phase should include studies of the immune responses of

cattle to *M. bovis* with the aim of identifying antigens that may prove useful for vaccination or diagnosis of this species (paragraphs 6.4.23 and 6.4.37).

6.6.9 Effective liaison between those responsible for the initial laboratory phase work and those responsible for the later stages will be essential to ensure the logistical requirements of implementation are fully taken into account in the early stages of vaccine development. We recommend that MAFF should consider how best to ensure effective co-ordination of the programme (paragraph 6.4.23).

6.6.10 There would be little short-term financial benefit in vaccination of cattle as a control strategy, although an effective vaccine could provide significant savings in the longer term. A full cost-benefit analysis should be carried out once the properties of an effective vaccine are known (paragraph 6.4.19).

6.6.11 Work essential to the development of a badger vaccine should proceed in parallel with cattle vaccine work to ensure this option remains open: in particular, the necessary immunological assays and diagnostic tests should be developed and an experimental model of infection in the badger should be put in place so that, in the longer term, selected vaccines, possibly including BCG, could be tested in the badger (paragraph 6.4.38).

6.6.12 It is essential that vaccine development work is co-ordinated with analogous vaccine development programmes for human TB. We recommend that MAFF should consider further how this might most effectively be achieved, including through the involvement of independent experts (paragraph 6.4.14).

6.6.13 Better epidemiological models, to evaluate the level of protection required of a vaccine to obtain significant benefit, should be developed (paragraph 6.4.24).

6.6.14 Procedures for treating the disease, distinct from those used in man, are worth investigation. We recommend further consideration of developing techniques for reducing TB infection in badgers through biological control, for example using bacteriophages to destroy *M. bovis* in the environment (paragraph 6.5.2).

7 Conclusions and recommendations

7.1 The scale of the problem

1.3

The above and subsequent marginal numbers refer to the section/paragraph(s) of the Report where the subject in the adjacent paragraph(s) is dealt with.

7.1.1 Bovine TB is currently a relatively uncommon disease in Great Britain as a whole. In 1996, new cases occurred in just over 0.4% of the cattle herds. However the disease is not uniformly distributed throughout the country. In parts of South-West England, with a history of herd breakdowns, the annual incidence of confirmed breakdowns is over 1%, whilst in parts of the North and East of Britain, the disease is virtually never recorded.

4.2

7.1.2 Since the late 1980s, the annual incidence has been increasing rapidly. This is principally because of increasing incidence in South-West England but also because the disease is occurring in other areas. There is a large cluster which has expanded north from Wiltshire and Avon, through Gloucestershire, to Hereford and Worcester. The disease is also occurring in areas with no recent history of infection (e.g. parts of West Staffordshire and the Gower Peninsula). Over the past 10 years annual incidence of confirmed breakdowns in South-West England has increased from 0.3% to over 1%. Over the rest of Great Britain the increase has been from 0.02% to 0.17%.

7.2 Why does it matter?

1.2

7.2.1 Bovine TB is currently a negligible risk to human health in the UK. In 1995, 32 out of approximately 3,200 cases of TB in which cultures were taken were due to *M. bovis*. *M. bovis* infection is found mainly in older people who may have contracted the disease before the present control measures were introduced. The annual risk of contracting culture-confirmed bovine TB (1 in 2 million) is extremely small in relation to the risk of contracting culture-confirmed *M. tuberculosis* TB (1 in 20,000), HIV (1 in 23,000), meningitis (1 in 20,000) or food poisoning (1 in 600). We therefore consider that the present measures of tuberculin testing and pasteurisation of milk are currently sufficient to protect public health. However, **we recommend** that the incidence of *M. bovis* TB in humans should be kept under review in the light of the increasing incidence in cattle and given the *potential* that it has to cause health problems in the human population.

7.2.2 In addition to the potential human health risk, we have identified four main arguments for further control measures at the present time.

- (i) Individual farmers experiencing herd breakdowns suffer financial losses – MAFF data show 1,722 farmers were affected by confirmed and unconfirmed breakdowns in 1996. Based on NFU data for 1995, MAFF estimate the average cost to a farmer, not taking cattle premium schemes into account, as £8,700.
- (ii) There are also the human welfare costs for farmers whose herds are affected.

- (iii) There are animal welfare grounds for reducing bovine TB to a minimum: the disease is likely to cause distress.
- (iv) The cost to the taxpayer of the TB controls, including testing, compensation, badger control and related activities is currently about £16 million a year. Under EU legislation the testing frequency is related to herd breakdowns. Therefore an increase in these could impose additional costs on the taxpayer. Calculation of this is not straightforward, but testing currently costs about £11 million a year.

7.2.3 If the incidence were to rise significantly this could, in principle, have significant trade implications. It might, for example, be necessary to impose movement licences on stock going from one region to another.

7.3 The link with badgers and other wildlife

7.3.1 The evidence that badgers transmit TB to cattle in the natural situation is all indirect. The strongest evidence is from cases in which complete, or near complete, removal of badgers from an area is followed by a reduction in, or complete cessation of, herd breakdowns. However, none of these has involved a properly controlled experiment. Other relevant evidence is as follows.

2.5

- (i) Limited laboratory studies have demonstrated that badgers can transmit TB to cattle.
- (ii) Infected badgers in the wild can shed large numbers of bacteria.
- (iii) There is substantial evidence for an *association* between infection in badgers and herd breakdowns.

The sum of this evidence *strongly supports the view* that badgers are a cause of herd breakdowns.

7.3.2 The attribution of the cause of herd breakdowns is based on a standard protocol. MAFF currently attributes between 80% and 90% of herd breakdowns in South-West England to badgers. Other possible causes include transmission from neighbouring farms, introduction of infected cattle and transmission from wildlife species other than badgers. The present protocol is not sufficiently rigorous in its design. **We therefore recommend** that attribution of the cause of breakdowns should be made more transparent: all breakdowns should be classified according to the presence or absence of badgers in the area. Information on whether or not infection has been detected (including the severity of any infection) in any badgers present should also be recorded where this information is available, for example from road traffic accident data.

4.2.5 to 4.2.7
Appendix 7

7.3.3 The Department of Agriculture for Northern Ireland (DANI) has carried out a statistical analysis of the role of badgers, comparing breakdown farms with unaffected control farms. This suggested that badgers were implicated in 41% of herd breakdowns

2.4.4, 2.4.5, 4.6.8,
4.6.9

on farms where no new cattle had been introduced. A complete statistical analysis, encompassing a range of information, should be carried out in Great Britain (see paragraph 7.5.7).

2.2

7.3.4 Badgers are not the only wildlife species to carry *M. bovis*. Previous estimates suggest that the prevalence is higher in badgers than in other species. The possibility of other wildlife species acting as reservoirs of infection should be kept under scrutiny.

We recommend that the risk to cattle from other species should be assessed in the areas of high herd breakdown risk taking account of four key factors:

- (i) prevalence of the disease;
- (ii) the severity of the disease and its effect on infectivity;
- (iii) abundance of the species; and
- (iv) the extent of contact with cattle including the movement range of the wildlife.

7.4 Field studies of badgers

3.3

7.4.1 There is a considerable body of knowledge on the ecology and behaviour of badgers in certain populations. The social structure varies from place to place. In high density areas badgers live in groups of up to 25 individuals and are highly territorial. In low density areas they can be solitary and non-territorial. They feed largely on invertebrates, but also on fruit and cereals and come into contact with cattle principally through foraging in pastures for worms or in farm buildings and through scent-marking along the edges of pastures.

7.4.2 A national survey in the mid to late 1980s estimated that the overall population of badgers in the UK was about 250,000. A further census in 1997 suggests that the number of badgers has increased between 1988 and 1997, with marked increases in the West Midlands and South-West England.

Table 3.1

3.6.2

7.4.3 Badger removal operations are not a threat to overall badger numbers. Data suggest that removal operations currently kill far fewer badgers in Great Britain than do road accidents: in 1986-1989 MAFF killed an average of 732 badgers per year in South-West England, while the carcasses of, on average, 1,044 badgers killed in road accidents were submitted annually by the public in the same area.

3.6.6 to 3.6.8

7.4.4 Removal of badgers from an area could exacerbate the problem of TB spread by disrupting the territorial system, which limits lateral transmission between groups. Evidence for this comes from three sources.

- (i) New badgers, including both non-territorial migrants and neighbours, invade territories from which individuals have been removed. Movements between territories also occur more frequently when population density is low.

- (ii) The pattern of defaecation and urination in a group appears to change when individuals have been removed.
- (iii) A small-scale study at Nibley in Gloucestershire suggests that remaining badgers in a group may range more widely when some members have been removed.

This evidence is not conclusive in proving that culling badgers exacerbates the problem of TB spread, but the possibility cannot be ignored. Any such effects would probably be most marked where there is incomplete trapping of social groups.

7.4.5 We recommend that future research on badgers should include three priorities:

- (i) extensive surveys that will contribute to analyses of how variation between local areas in the risk of herd breakdown is connected with badger presence or absence and variations in the prevalence and severity of the disease in badgers (paragraphs 7.5.5 to 7.5.7);
- (ii) using molecular epidemiology to understand more about the badger to cattle transmission dynamics within intensively studied areas (section 7.6); and
- (iii) estimation of recolonisation times (paragraph 7.8.15) at sites subject to the proactive and reactive culling strategies referred to in paragraph 7.8.13.

7.5 Epidemiology of the disease in badgers and in cattle

7.5.1 Cattle become infected with *M. bovis* by inhalation or ingestion of bacteria. In many cases the infection is confined to the lungs and lymph nodes associated with the respiratory tract but in a minority of cases it spreads throughout the body. Animals may be infected for months or years before showing obvious clinical signs. During this period they intermittently excrete *M. bovis* in nasal secretions. Under the current regime of herd testing animals rarely display overt signs of the disease.

7.5.2 The course of infection and the main features of the disease appear to be broadly similar in badgers but there appears to be greater variation in its severity. Some infected animals remain free from clinical signs for several years and are intermittent excretors, whilst others develop severe disease within a few months and excrete large amounts of bacteria in sputum and in some cases also in pus and urine (up to 200,000 organisms per ml and 300,000 organisms per ml in pus and urine respectively).

7.5.3 *M. bovis* infection may be highly localised within badger populations. Transmission seems to occur more frequently within, rather than between, social groups.

7.5.4 Unquantifiable biases in the data on prevalence of TB in badgers mean that it is difficult to relate patterns of infection in cattle and badgers over time and space. These problems are further exacerbated by the paucity of data available following the cessation of the road traffic accident survey.

6.2

3.4.1 to 3.4.6

3.4.9 to 3.4.16

4.3

4.3.13, 4.3.14

7.5.5 Testing of road traffic accident badgers offers an important source of data on the underlying disease prevalence. **We recommend** a limited reintroduction of the road traffic accident survey targeting areas with high (including the areas of the experiment referred to in paragraph 7.8.13) or increasing herd breakdown rates and nearby areas with low breakdown rates. Data gathered in this way on the prevalence and severity of the disease will allow a more rigorous analysis of the link between herd breakdowns and the prevalence of TB in badgers over time and space.

4.2, 4.6

7.5.6 The distribution of herd breakdowns in Great Britain is very patchy. Most herds do not suffer from TB and, of those that do, most (85%) had only one breakdown between 1987 and 1996. Even within the geographical areas of high overall risk, such as South-West England, the risk varies greatly on a local scale. We do not currently understand why.

4.6.16, 4.6.17

7.5.7 **We recommend** that an analysis is carried out to determine the correlates of local variation in risk. Relevant data will include presence/absence of badgers, prevalence and severity of TB in badgers, husbandry, climate and landscape variables. Data should be collected for high and low risk locations. Sources of information would include the data from rigorous attribution of the cause of herd breakdowns (some sampling of badgers would be necessary in low risk areas), the recommended road traffic accident survey and other newly collected information.

7.5.8 This analysis would encompass the approach taken by DANI in their case control study and provide quantitative evidence on the relative importance of badgers and other factors contributing to herd breakdowns. It may also provide indications for future husbandry policies. This analysis should be completed within the next 18 months.

3.4.13, 3.5.3

7.5.9 There are various estimates of survival of *M. bovis* in the environment. MAFF data suggest survival ranging from three days (*M. bovis* in urine on pasture in summer) to 70 days (*M. bovis* in bronchial pus in winter). Survival times are probably longest at relatively high humidities and under dark conditions such as are found in badger setts and farm buildings. Weather conditions also probably affect survival times and hence cattle exposure to bacteria on pasture.

2.5.2 to 2.5.4, 3.5

7.5.10 Urine has been proposed as a significant source of infection. MAFF data indicate that about 13% of badgers with visible lesions suggestive of TB have lesions in the kidneys, and urine is known to contain high levels of *M. bovis*. Scent-marking by urination at boundaries is a prominent aspect of badger behaviour. However there is no quantitative evidence with which to evaluate the relative importance of urine and other sources of infection.

7.5.11 Establishing transmission routes is highly desirable, partly because of the implications for husbandry and partly because of the contribution this would make to

understanding local variation in risk. **We recommend** that further consideration should be given to whether appropriate techniques can be developed to research this issue.

7.6 Molecular typing of the infective agent

7.6.1 In principle the 'molecular fingerprinting' of *M. bovis* in badgers should provide conclusive evidence to determine whether, and to what extent, badger to cattle transmission occurs. MAFF has started to type *M. bovis* using spoligotyping. Analysis of these data shows that there is spatial clustering of types and an association between types in badgers and in cattle.

4.4

7.6.2 **We recommend** extending the use of these tools to analyse the spatial and temporal dynamics of the disease in badgers and other wildlife as well as cattle. This should be a carefully designed, intensive study over restricted areas. The optimal procedure would involve a combination of two or more methods of molecular typing.

7.7 Modelling

7.7.1 Mathematical modelling is an important tool in understanding the epidemiology and control of *M. bovis* in badgers. Modelling studies have, so far, taken one of two complementary approaches. The first uses relatively simple analytical models. The second involves complex, detailed simulations.

4.5

7.7.2 The first category of models has been used to identify potentially important factors in disease transmission and in population dynamics of badgers. The second could, in theory, be used to simulate the effectiveness of different culling strategies. However, at the moment there are insufficient data to parameterise the models.

7.7.3 Various modelling approaches should be deployed in future to contribute to the understanding of disease transmission.

- (i) Combined use of geographical information systems and epidemiological models may help to understand *M. bovis* transmission on a wide spatial scale (see also paragraph 7.5.7).
- (ii) Statistical models can help design field trials to test the predictions of transmission models.
- (iii) Linking economic and transmission models can help to assess the costs and benefits of different control strategies.

7.7.4 The integrative modelling approach is common practice in medical epidemiology and has been used in the analysis for this Review. **We recommend** that its use should be extended to future modelling studies. MAFF should harness external expertise to extend its capacity in this area. **We further recommend** that there should be better liaison between modellers and MAFF to ensure that the data gathered are better able to meet research needs.

7.8 Badger management and control strategies

Previous strategies

5.2 to 5.4

7.8.1 During the past 20 years, MAFF has used four culling policies: gassing, clean ring, interim and live test. 'No culling' has not been used as a policy, although in one site in a region of relatively high TB incidence (Woodchester Park, Gloucestershire), badgers have not been culled for many years.

7.8.2 The policies have not been compared in a properly designed experiment for their efficacy in reducing the incidence of TB in cattle. It is therefore not possible to draw firm conclusions about their effectiveness or to analyse their relative cost-effectiveness. However, the following paragraphs indicate the conclusions that can tentatively be drawn.

7.8.3 The gassing and clean ring strategies, in effect, eliminated or severely reduced badger populations from an area and appear to have had the effect of reducing or eliminating the occurrence of TB in local cattle populations. The effect lasted for many years after the cessation of culling, but eventually TB returned.

7.8.4 The interim strategy, introduced following the Dunnet report, is not likely to be effective in reducing the badger-related incidence of TB in cattle for the following reasons.

- (i) The policy involves removing badgers from a limited area (the reactor land, or the entire farm suffering the herd breakdown if the former cannot be defined); but social groups of badgers may occupy several setts covering more than one farm.
- (ii) Partial removal of groups could exacerbate the spread of TB by perturbation of the territorial social structure and increased movement of badgers (paragraph 7.4.4).
- (iii) There is no attempt to prevent recolonisation by badgers of potentially infected setts: even if infectivity in the setts is not a problem, immigrant badgers may bring in new infection.

In addition, the current operation of the interim strategy involves a delay (27 weeks in 1995) to the start of the removal. The average period from the herd breakdown to the completion of the removal was 41 weeks in 1995.

3.6.5

7.8.5 In common with the clean ring strategy and the live test trial, the effectiveness of the interim strategy is further undermined by the failure to remove lactating sows, which may also be infected. We recognise that culling lactating sows has a welfare cost in terms of the cubs left in the setts but this needs to be balanced against wider animal health and welfare considerations for both cattle and badgers.

7.8.6 The rapid increase in incidence of TB since the late 1980s has coincided with the introduction of the interim strategy. It might be tempting to conclude that the increase in cattle breakdowns has been caused by the introduction of the strategy. However many other changes could account for the increase (e.g. climatic effects, increasing badger populations). Whilst the interim strategy has apparently not been effective in preventing the recent increase, there is no basis on which to compare its effectiveness with that of any other strategy.

7.8.7 The live test trial aimed to target culling at infected badgers or setts with infected badgers. However, simple calculations show that with the low sensitivity of the live test for TB in badgers (41%), and assuming a disease prevalence of 30%, even doubling the number of animals previously caught for testing would give only a 50% chance of detecting infection at a particular sett.

7.8.8 The efficacy of the test could in principle be improved by applying it to whole social groups rather than to individual setts. This would involve the additional effort of mapping social group boundaries as well as increasing the number of animals tested. We therefore conclude that the live test does not form the basis of a cost-effective control strategy.

7.8.9 All the previous control strategies have been 'reactive' (implemented in response to herd breakdowns). The key features which are likely to influence the effectiveness of any reactive strategy include the following:

- (i) the size of the area cleared (including the extent to which this takes into account badger territoriality);
- (ii) the efficiency of the badger removal operation (to ensure all infected badgers are removed and minimise any problem of perturbation associated with partial removal of social groups); and
- (iii) the prevention of recolonisation for a sufficient period.

7.8.10 'No culling' has been applied in Great Britain only at Woodchester Park where there has been no culling at all since 1979. Here, the incidence of herd breakdowns is not statistically different from that in the surrounding areas where the interim strategy has been in force. However, the analysis is based on a small sample size; the comparison was not set up as a formal experiment; and Woodchester Park may well be an atypical area. This evidence does not therefore provide a sufficient basis on which to compare the impact of 'no culling' with culling.

7.8.11 We have considered the prospects for fertility control as a TB control strategy. We conclude that fertility control is likely to be less effective than culling as a strategy to reduce TB in badger populations and hence transmission to cattle.

5.3, Appendix 15

5.2

5.6.2

5.5

Future strategies

- 5.6** **7.8.12** Although culling appears to be effective in some circumstances, we cannot, on the basis of the present evidence, compare the impact and cost-effectiveness of different strategies. A proper experimental assessment is the only way to test rigorously the effectiveness (and also cost-effectiveness) of different strategies and to provide a sound basis for future policy. Although this would have significant resource implications for the Government, these must be considered in the context of the actual and potential costs of TB. An analogy might be the evidence required to recommend the widespread use of a new therapeutic drug.
- 7.8.13** **We therefore recommend** a randomised block experiment of three strategies: a reactive culling strategy, a proactive culling strategy and a no culling strategy.
- 5.6.4 to 5.6.9** **7.8.14** We suggest that the most appropriate *reactive* strategy would be to target culling at social groups where a badger-attributed breakdown has been identified. This would involve removing all badgers, including lactating sows, from all social groups, with territories including the breakdown farm (or the reactor land if this can be rigorously identified). There should be sufficient follow-up to ensure that every member of every social group which could have caused the initial breakdown has been removed.
- 7.8.15** Ideally recolonisation of setts should be prevented for a period under the reactive strategy. This would be costly. We therefore consider that the costs should be balanced against the potential benefits in deciding whether this should be included in the detailed experimental design. In any event, given the lack of data on recolonisation times, **we recommend** that further research should be done on this in areas subject to both the reactive and proactive control strategies.
- 5.6.10 to 5.6.13** **7.8.16** *Proactive* and *no culling* strategies are essential elements of the experiment to provide benchmarks against which to assess the effectiveness of the reactive strategy. If culling is effective, proactive culling would give the earliest indication of this.
- 7.8.17** The proactive strategy would involve total removal of complete badger social groups from localised areas at high risk of breakdown *before* herd breakdowns. This strategy would require regular monitoring and also, probably, revisiting after two to three years to deal with renewed badger populations.
- 5.6.16 to 5.6.24** **7.8.18** The three treatments should be applied in the 'hot-spots' where the risk of contiguous and repeat breakdowns is greatest. Here their impact will be most quickly seen and also greatest, and hence most readily assessed. These areas can be identified from the history of past breakdowns. Our analysis suggests possible criteria for inclusion in the experiment and identifies about 30 10km by 10km square areas in England and Wales which meet these. These squares would encompass about two thirds of the repeat and contiguous breakdowns which have occurred over the last five years (1992 to 1996).

7.8.19 To be effective, the experiment must encompass a sufficient number of areas and each one must be of sufficient size. It must include a randomised design and should have equal numbers of areas assigned to each of the three treatments at the outset. The Government would need to consider any legal implications of imposing particular treatments on particular areas. We consider that 30 10km by 10km ‘hot-spot’ areas would be the minimum required for the experiment to provide sufficient statistical power. We calculate that the proposed sample size would be very likely to detect a 20% drop in TB breakdowns in five years. The cumulative number of badgers killed in the five years of the experiment is unlikely to be substantially different from the number killed in the present interim policy (roughly 2,000 a year on the basis of 1996 figures). Moreover, it is likely to be significantly less than the number killed in road traffic accidents.

5.6.29

7.8.20 Such an experiment would have two key results. First, it would provide unambiguous evidence on the role of the badger in cattle TB. Secondly, it would provide quantitative data for a cost-benefit analysis of the different strategies, including ‘no culling’. Through appropriate modelling, and taking account of the results of the multi-variate analysis of local variations in risk recommended in paragraph 7.5.7 above, it would provide a basis for determining appropriate policies for both ‘hot-spots’ and other areas. It is important that MAFF does not delay the start of this experiment.

We recommend that it is initiated within four months (by spring 1998).

7.8.21 We recommend that the following measures should be taken to enhance the efficacy of badger removal operations.

- (i) The average 41 week delay from the herd breakdown to completion of the badger removal operation is undesirable: targets for reduced delays should be set and monitored for removal operations.
- (ii) The use of stop-snaring should be explored as an alternative to trapping where badgers are to be culled, taking account of efficacy, cost and welfare considerations.

5.6.6

5.6.8

7.8.22 We also recommend that further consideration should be given to what farmers themselves can contribute. This is important to secure their ‘ownership’ of the experimental approach. It is in their interests to ensure that the experiment is properly implemented and not undermined in any way. Farmers might be involved in a number of ways: with MAFF carrying out appropriate training and supervision, they could perform a substantial element of the operation (e.g. mapping setts, pre-baiting traps). They might also be involved in identifying and recording badger activity. In addition, they could contribute to the costs.

5.6.37

7.8.23 We recommend that an independent Expert Group, including statisticians and mathematical epidemiologists, should be established to oversee the detailed experimental design, including the final determination of the areas to be included in the experiment.

5.6.14, 5.6.15, 5.6.19

5.6.25 to 5.6.27

They should also monitor the progress of the experiment and the TB situation in areas outside the experiment. A key function would be regularly to analyse the data (blind, to the extent possible, and on a confidential basis) to judge if the experiment is showing significant differences between the three treatments which would require it either to be modified or stopped altogether. We envisage that five years would be required to provide data for the necessary *quantitative* analysis of the relative efficacy of the three strategies. However, *qualitative* results may be available earlier (possibly within two to three years).

5.6.34 to 5.6.36

7.8.24 Outside the experimental area, there would be three main possibilities:

- (i) no culling;
- (ii) the reactive strategy, as applied in the main experimental areas; or
- (iii) an extension of the experiment.

7.8.25 On balance **we recommend** that no culling should be carried out outside the hot-spot areas. Given the low risk of TB breakdown and the even lower risk of repeated breakdown, areas outside the highest risk 'hot-spots' are not best suited for testing culling strategies. The costs of extending the area of the experiment to lower risk areas therefore have to be balanced against the limited value this would add. However, TB incidence in cattle and prevalence in badgers in these areas should be kept under review. **We recommend** that the Expert Group should keep under review whether there is sufficient evidence that any new herd breakdown areas, which are not picked up by the analysis of historical data, might justify inclusion in the experiment.

Husbandry

5.7

7.8.26 We suggest that areas outside the main experiment would be suitable for testing a small number of proactive husbandry methods to assess the extent to which these might be effective in reducing risk. We recognise that husbandry may be more appropriate in some circumstances than others. Nonetheless, it is important that there is every incentive for farmers to take all possible measures to protect their herds against the disease and minimise costs to the taxpayers. Comparison of husbandry practices would form part of the analysis of the risk of herd breakdowns referred to in paragraph 7.5.7. **We recommend** the possibility of testing various proactive husbandry strategies should be explored with the farming industry.

7.8.27 The primary responsibility for implementing an experimental evaluation of husbandry should be with the farming industry. The role of MAFF should be to provide advice on design and analysis of the experiment (this could be done by the independent Expert Group referred to in paragraph 7.8.23) and to determine any incentives that might be provided. Husbandry may well prove to be part of the long-term solution.

7.9 Diagnostic tests

Cattle

7.9.1 The skin test has a sensitivity, defined as the proportion of infected animals correctly identified, of between 77% and 95%, based on the 'standard interpretation' of the test. The specificity, defined as the proportion of uninfected animals correctly identified, is over 99%. These figures are based on the application of the test at the level of the individual animal. However, if the test is applied at herd level, the sensitivity is higher.

6.3.3 to 6.3.23

7.9.2 Research so far in Northern Ireland and Australia shows the interferon-gamma blood test to be comparable to the tuberculin test in terms of sensitivity, but inferior in terms of specificity and that the two tests detect slightly different groups of positive animals. A blood test would potentially have benefits in minimising the disruption and inconvenience of testing for farmers. It could be useful for retesting animals in breakdown herds. DANI is also working on a diagnostic test comprising cocktails of antigens. Again this has not so far shown significant improvements in specificity or sensitivity but this work could have benefits for vaccine development.

7.9.3 A significant amount of work is going on in other countries on diagnostic tests and Great Britain should benefit from this. We believe that any improvements in this area will be incremental. We conclude that further work in Great Britain should therefore focus on a vaccine related diagnostic test (see paragraph 7.10.8 below).

Badgers

7.9.4 The live test for badgers, the so-called BROCK test, detects only about 40% of infected badgers. Development of improved diagnostic techniques could have a significant impact on control strategies and could be an important tool for epidemiological surveillance. In particular, a blood-based immunological test would be essential to monitor any badger vaccination programme (see paragraphs 7.10.11 and 7.10.12 below).

6.3.24 to 6.3.29

We recommend that work on development of improved tests for badgers should be pursued in the context of the vaccination programme. This would have a lower priority than development of the vaccine related diagnostic test for cattle.

7.9.5 **We also recommend** that the scope for using modern DNA amplification techniques, such as the polymerase chain reaction (PCR), for diagnosis should be further explored. The PCR is quicker than microbial culture and can detect the remnants of dead bacteria in addition to living organisms. If sufficiently sensitive, we see two applications for such a test.

- (i) It could provide rapid screening of samples from badger carcasses. We suggest MAFF should consider whether this might be an alternative to culture. We estimate that existing assays could be optimised within one to two years.
- (ii) MAFF could monitor the presence and distribution of infection by environmental sampling of areas used by badgers.

6.4

7.10 Vaccines

7.10.1 We recommend that the best prospect for control of TB in the British herd is to develop a cattle vaccine. This is a long-term policy and success cannot be guaranteed. But the potential benefits are substantial and we consider this should be a high priority. Currently no money is targeted at this specific area although 26% of MAFF's total TB research budget is spent on the related area of badger vaccines.

7.10.2 The time is ripe to build on the major world-wide current research on human vaccine development: the similarity between *M. bovis* and *M. tuberculosis* means that results from genome sequencing and identification of antigenic properties are likely to have substantial read-across. We recommend that vaccine development work should be co-ordinated with analogous programmes for human TB and that MAFF should give further consideration to how this might most effectively be achieved, including through the involvement of independent experts. Note should also be taken of cattle vaccine work being carried out in other countries, especially New Zealand.

7.10.3 Two approaches to vaccine development should be further considered: a genetically modified live attenuated vaccine and one made of antigenic elements (a subunit vaccine). Each has advantages and disadvantages that require further consideration. The latter approach is clearly preferable in terms of safety and quality control. However, a live attenuated vaccine may be easier to achieve.

6.4.22, 6.4.23

7.10.4 Vaccine development would fall into three phases, each of about five years: identification of candidate vaccines; experimental investigation of vaccination protocols; and field trials. We recommend that the first stage should include research on the immune responses of cattle to *M. bovis* with the aim of identifying antigens which may be useful in vaccination or diagnosis. We also recommend that MAFF should consider how best to ensure effective co-ordination between those responsible for the initial laboratory phase and those responsible for the later stages so that the logistical requirements of implementation are fully taken into account in the early stages.

7.10.5 Our current estimate is that a vaccine for field trials could be available within ten years, if the best groups in the UK were harnessed to work on the problem. However, achieving this timetable will require considerably more resources than the £0.4 million a year currently spent by MAFF. We recommend that progress should be formally reviewed after five years, taking account of developments in wider, related areas (including the results of the culling experiment).

6.4.17

7.10.6 If the majority of herd breakdowns are due to a wildlife source of infection, a sustained programme of vaccination would be needed. A cattle vaccine would not have to have 100% efficacy: the efficacy required depends on the risk of infection and this is different in different parts of the country. Given the objective of reducing testing to four yearly intervals, one model suggests that an efficacy level of at least 90% would be necessary

to secure eventual control of the disease in cattle in high risk areas. A lower efficacy vaccine could achieve the same results if used in conjunction with other control methods that lower the risk of infection (e.g. reduction of infection in badgers and husbandry).

7.10.7 If MAFF were to bear the full costs of delivering the vaccination to cattle, although there could be significant savings in the longer term, it would be likely to cost more than the current testing regime in the first few years. Alternatively farmers could bear the cost of vaccination. Once the properties of an effective vaccine are known, a cost-benefit analysis would have to be performed. **We recommend** that better epidemiological models should be developed to evaluate the level of protection required of a vaccine to obtain significant savings.

7.10.8 Use of a cattle vaccine is effectively prohibited by the current EU legislation because it would compromise the tuberculin skin test. It will be crucial to develop a specific diagnostic test which can detect and differentiate between infected animals, including those that have become infected even after vaccination, and vaccinated animals. A vaccine such as BCG, for example, could result in false positive reactions using the current tuberculin test. **We recommend** that such a test should be developed alongside the vaccine. In due course further consideration should also be given to including some form of molecular 'tag' in the vaccine to enable identification of vaccinated animals.

7.10.9 Legal and international trade implications of a vaccine would have to be addressed at an early stage, bearing in mind that bovine TB is not a uniquely British problem.

7.10.10 Vaccination could be applied to cattle or to badgers. Research undertaken during the initial stages of a vaccine programme (first five years) would be relevant to both strategies. We believe that a cattle vaccine currently offers a more feasible goal, and so should have the highest priority, for three key reasons:

- (i) ease of delivery;
- (ii) the availability of experimental animals for development trials; and
- (iii) cattle are the ultimate target. Vaccination of badgers would not address disease in cattle arising from sources other than the badger.

7.10.11 Vaccine requirements for badgers are less demanding than those for cattle. A badger vaccine would require merely reduction of bacterial excretion, whereas a cattle vaccine would require prevention of the establishment of infection. A badger vaccine would also have a useful effect in reducing the likelihood of badger to cattle transfer even if only a proportion of the badger population were vaccinated. **We therefore recommend** that the option of a badger vaccine, using the information gained in cattle work, should be retained as a fall-back position if the cattle vaccine requirements cannot be met.

6.4.22, 6.4.36 to
6.4.38

6.4.38

7.10.12 We further recommend that some work essential to the development of a badger vaccine is pursued in parallel with the cattle vaccine work. In particular, it will be essential:

- (i) to have susceptible badgers and appropriate containment facilities to test candidate vaccines; and
- (ii) to develop a blood-based immunological test which would have an important role in monitoring any vaccination programme. As for cattle, such a test would be required to differentiate between naturally infected and vaccinated animals.

7.10.13 There could be commercial interest in developing a cattle vaccine.

We recommend that MAFF should explore the possibility of partnership with industry in developing a vaccine.

7.11 Biological control

6.5

7.11.1 The risk of transmission of human TB is reduced partly by vaccination and partly by treatment of infections. **We recommend** that further consideration should be given to developing techniques for reducing TB infection in badgers through biological control, for example using bacteriophages to destroy *M. bovis* in the environment.

7.12 Data availability

7.12.1 Key data have not always in the past been readily available to researchers in this area. We have seen welcome signs of a change of approach but **recommend** that there should be a clear commitment by Government to ensuring data are made available at the earliest possible opportunity. This will ensure that important research opportunities are not lost or postponed and make optimum use of the inevitably limited public resources available for research in this area.

7.12.2 We suggest, in particular, that details of MAFF databases should be entered on web sites. Due note should be taken of restrictions under the Data Protection Act and other considerations, e.g. intellectual property rights. If necessary, access to the actual databases could be restricted to bona fide enquirers and clear guidelines could be issued on policy for data users.

7.13 Research

1.7

7.13.1 Only 5% of MAFF's £1.7 million TB research budget is currently contracted out. **We recommend** MAFF should ensure in future that research is commissioned from those with the best expertise from throughout the UK research community. **We also recommend** that MAFF should look at partnerships with industry, universities and other funding agencies to develop a more co-ordinated approach.

7.13.2 Over nine times as much money is spent on TB control (£16 million a year) as is spent on TB research (£1.7 million a year) in Great Britain. This contrasts with the position in New Zealand where the absolute amount spent on research by the Government is nearly three times as high (nearly £5 million) as in Britain and the amount spent on control is just under twice that spent on research. The money spent on research in Britain is very small given the economic cost of the disease and the uncertainties that surround many key issues. Given the need for substantial continuing research in this area **we recommend** that the Government should review the amount spent on research in absolute terms and consider whether the allocation of resources between research and control costs is correct and the extent to which it would be reasonable for the main beneficiaries (the farmers) to contribute to the control costs from which they benefit directly.

7.14 Summary of recommendations

7.14.1 We have grouped our recommendations into four categories.

A. To understand the causes of herd breakdown, we recommend:

- (i) statistical analysis and epidemiological modelling to assess the correlates of local variation in risk, taking account of the presence of badgers, together with prevalence and severity of TB, and husbandry, climate and landscape variables (paragraphs 7.4.5(i) and 7.5.7). This will include:
 - (a) collection of more detailed and transparent data on herd breakdowns (paragraph 7.3.2);
 - (b) a limited reintroduction of the road traffic accident survey in areas with high, low and increasing TB breakdown rates (paragraph 7.5.5);
 - (c) collection of additional data;
- (ii) application of molecular strain typing techniques in combination for longitudinal study of TB transmission between wildlife and cattle (paragraphs 7.4.5(ii) and 7.6.2);
- (iii) development of improved tests for detection of *M. bovis* in badger carcasses and in environmental samples using DNA amplification techniques (paragraph 7.9.5);
- (iv) development of appropriate techniques for research to establish transmission routes (paragraph 7.5.11); and
- (v) analysis of the risk to cattle from other wildlife species in areas of high herd breakdown (paragraph 7.3.4).

B. To evaluate the effectiveness of currently available strategies to reduce herd breakdowns, we recommend:

- (i) a randomised experiment to be put in place immediately to determine the impact and effectiveness of 'no culling' and proactive and reactive culling policies (paragraph 7.8.13) in a minimum of 30 hot-spot areas identified including:
 - (a) the formation of an independent Expert Group, including statisticians and mathematical epidemiologists, to determine the areas to be included in the experiment, to oversee the experimental design and to monitor progress and the TB situation in areas outside the experiment (paragraph 7.8.23);
 - (b) estimation of recolonisation times at sites subject to the culling strategies (paragraphs 7.4.5(iii) and 7.8.15);
 - (c) removal of lactating sows in the reactive and proactive culling treatments (paragraph 7.8.5); and
 - (d) further measures to enhance the efficiency of badger removal operations, including through increased involvement of farmers (paragraphs 7.8.21 and 7.8.22);
- (ii) no culling should be undertaken outside the hot-spot areas subject to the experiment (paragraph 7.8.25);
- (iii) husbandry may well play an important role as part of the long-term solution. MAFF should work with the farming industry to evaluate the effect of various proactive husbandry methods on the incidence of herd breakdown in areas outside the main experiment with:
 - (a) the industry taking the lead and primary responsibility for implementation; and
 - (b) MAFF facilitating, providing advice on the design and analysis of the experiment, and determining any incentives that might be provided (paragraph 7.8.26 and 7.8.27).

C. To develop improved strategies to reduce herd breakdown, we recommend:

- (i) development of a vaccine to protect cattle against TB (paragraph 7.10.1) including:
 - (a) better co-ordination with human TB vaccine programmes (paragraph 7.10.2);
 - (b) development of a diagnostic test to distinguish infected from vaccinated cattle (paragraph 7.10.8);
 - (c) research on the immune responses of cattle to *M. bovis* with the aim of identifying antigens which may be useful in vaccination or diagnosis (paragraph 7.10.4);

- (d) effective liaison between those responsible for the initial laboratory phase and those responsible for the later stages to ensure the logistical requirements of implementation are fully taken into account in the early stages (paragraph 7.10.4);
- (e) epidemiological modelling to predict the effectiveness required of a cattle vaccine (paragraph 7.10.7); and
- (f) exploration of partnership with industry in vaccine development (7.10.13);
- (ii) the option of a badger vaccine to protect against TB should be retained (paragraph 7.10.11), including:
 - (a) developing procedures for evaluation of vaccines in badgers (paragraphs 7.10.12);
 - (b) development of a blood-based immunological test for badgers (paragraphs 7.9.4 and 7.10.12);
- (iii) further consideration should be given to the possibility of reducing TB infection in badgers through biological control, for example using bacteriophages (paragraph 7.11.1).

D. Other recommendations are:

- (i) extending the use of integrative modelling (paragraph 7.7.4), including:
 - (a) harnessing external expertise in this area; and
 - (b) better liaison between data collectors and modellers to ensure data gathered are best able to meet research needs;
- (ii) a clear commitment by Government to ensuring data are made available for research at the earliest opportunity (paragraph 7.12.1);
- (iii) research should be commissioned from those with best expertise from throughout the research community (paragraph 7.13.1);
- (iv) development of a better co-ordinated approach to research through partnerships with industry, universities and other funding agencies (paragraph 7.13.1);
- (v) to review the amount spent on research both in absolute terms and as a proportion of the total MAFF TB budget (paragraph 7.13.2) including consideration of the extent to which it would be reasonable for farmers to contribute to measures from which they benefit directly, bearing in mind the comparison with New Zealand;
- (vi) the incidence of *M. bovis* TB in humans should be kept under review in the light of the increasing incidence in cattle (paragraph 7.2.1).

Consultation

1 We conducted extensive formal and informal consultation to ensure that all interested parties were given the opportunity to contribute to our work. We are most grateful for the valuable inputs of everyone who responded. We gathered evidence in a variety of ways:

- (a) written evidence from interested organisations and individuals;
- (b) oral evidence given in presentations and meetings and during visits to affected areas;
- (c) a 'town meeting' in June, attended by key experts and representative groups.

Written evidence

2 All interested parties were invited to submit written evidence. In all, 68 submissions were received, including 31 from the following organisations and academic institutions:

Bluebell Sett Clinical Studies Group
British Veterinary Association
Country Landowners' Association
Dartmoor Badgers Protection League
Devon Cattle Breeders' Society
English Nature
Family Farmers' Association
Farmers' Union of Wales
Gloucestershire County Council
Institute of Terrestrial Ecology
Lancashire Badger Group
Livestock Auctioneers' Association
Mammal Society
Medical Research Council
National Cattle Association
National Farmers' Union (London)
National Farmers' Union (Central, South West and West Midlands Regions)
National Trust
Radstock Co-operative Society Ltd
Royal Agricultural Society of England
Royal College of Veterinary Surgeons
Royal Society for the Prevention of Cruelty to Animals
University College London Medical School (Dr Helen Donoghue – joint submission with Miss Eunice Overend)

Ulster Farmers' Union
University College, Cork (Professor Máire Mulcahy and Dr Paddy Sleeman)
University of Liverpool (Professor Andrew Cossins and Professor Tony Hart)
University of Oxford (Wildlife Conservation Research Unit and Fauna and
Flora International)
Wildlife and Countryside Link (comprising the National Federation of Badger
Groups, Mammal Society, RSPCA, Wildlife Trusts)
Women's Farming Union

3 In addition, 37 submissions were received from individuals. All written submissions are available, except where confidentiality has been requested, in the main MAFF library at 3 Whitehall Place, London SW1A 2HH to personal callers or telephone enquirers (Tel: 0645 335577).

Oral evidence

Presentations

4 Presentations were made to the Review Group by:

Mr John Gallagher, retired Senior Veterinary Investigation Officer, Starcross
Veterinary Investigation Centre
Professor Stephen Harris, University of Bristol
MAFF (Dr Kate Brown, Mr Andrew Turnbull), including Central Science
Laboratory (Dr Chris Cheeseman) and Veterinary Laboratories Agency
(Dr Richard Clifton-Hadley and Dr Glyn Hewinson)
Dr David Macdonald, University of Oxford
Dr Tim Roper, University of Sussex
Dr Dick van Sooligen, National Institute of Public Health and the Environment,
the Netherlands

Meetings and visits

5 In addition, meetings were held with representatives from key interest groups to discuss the issues raised in their submissions in more detail:

- (a) the farming industry (the Country Landowners' Association, the Farmers' Union of Wales and the National Farmers' Union);
- (b) veterinary interests (the British Veterinary Association and the Royal College of Veterinary Surgeons); and
- (c) wildlife organisations (Wildlife and Countryside Link, representing the National Federation of Badger Groups, the Mammal Society, the RSPCA and the Wildlife Trusts).

6 Visits were made to a beef farm and a dairy farm in South-West England, to the MAFF Wildlife Unit and to the Woodchester Park Badger Research Station.

7 As part of learning about experience elsewhere, we visited the Agriculture Departments in Northern Ireland and the Republic of Ireland and discussions were held with Dr Terry Ryan and Dr Robert Sanson of the Ministry of Agriculture and Fisheries in New Zealand.

Town meeting

8 To supplement this consultation, the main questions to be addressed in the final report were outlined and discussed at a 'town meeting' on 25 June 1997 attended by 37 key experts and representative groups.

Proportion of total herds with reactors (both confirmed and unconfirmed) 1962 to 1996

Year	South-West England	Rest of England and Wales
1962	2.95	1.45
1963	1.8	1.07
1964	1.9	0.68
1965	1.48	0.56
1966	1.56	0.44
1967	1.65	0.4
1968	1.43	0.36
1969	1.75	0.34
1970	1.6	0.3
1971	1.7	0.25
1972	1.5	0.2
1973	1.5	0.17
1974	1.4	0.15
1975	1.65	0.25
1976	0.87	0.05
1977	0.56	0.06
1978	0.5	0.04
1979	0.4	0.04
1980	0.63	0.08
1981	0.7	0.05
1982	0.57	0.07
1983	0.63	0.11
1984	0.73	0.12
1985	0.75	0.11
1986	0.75	0.10
1987	0.85	0.09
1988	0.86	0.09
1989	0.96	0.14
1990	1.24	0.16
1991	1.80	0.23
1992	1.59	0.27
1993	2.47	0.33
1994	2.94	0.29
1995	2.46	0.38
1996	2.61	0.51

Note: details of confirmed breakdowns were not available for this period. Nor were comparable data available for Scotland.

Source: MAFF data.

Key operational features of badger control strategies

1975 to 1982 – Gassing strategy

- Gassing of badgers was legalised under the Conservation of Wild Creatures and Wild Plants Act 1975.
- Licences were issued only to MAFF staff (or those under their control).
- Voluntary agreement of herd owners was required to enter their land and carry out gassing.
- An epidemiological investigation was carried out to determine the origin of the cattle infection and eliminate possible sources of disease other than badgers.
- If badgers were implicated, the population was sampled to determine its infection status – in practice two carcasses per social group, with a minimum of five in the sample, plus faeces sampling.
- If infection in badgers was confirmed, an area up to one kilometre from the farm boundary was surveyed, to include the full territories of badgers on the infected farm: social groupings of setts were identified using field workers' experience and the location of setts.
- All infected social groups, and groups in contact with them, were gassed. The area gassed was determined by the location of infected farms, infected badgers (samples, including from road traffic accidents), sett groupings and natural boundaries.
- All setts in the control area were gassed whether active or inactive.
- Gassed setts were revisited every three months for two years: in the first 12 months, reoccupied setts were regassed to prevent recolonisation; after 12 months, recolonised setts were gassed only if positive badgers/faeces were found.
- Hydrogen cyanide was considered inhumane by 1982 (following an investigation by Porton Down as recommended by Lord Zuckerman).

1982 to 1986 – Clean ring strategy

- An epidemiological investigation was carried out to eliminate sources of infection other than badgers.
- Badger social groups were delineated by surveys and bait-marking. This required high staff resources and was optimal only in spring when there was less vegetation and more badger activity.
- Infection in badgers was identified by examining (post-mortem and culture) a sample of carcasses – two per social group.

- *Infected social groups* plus contiguous groups were cage-trapped and *culled* for post-mortem and laboratory examination.
- *Lactating sows* were released (whether or not infected).
- Social groups contiguous to infected groups continued to be removed until a *clean ring of social groups* containing no infected individuals had been found and removed, or until there was no badger activity.
- *Recolonisation* by badgers was prevented for 6 months by further trapping to prevent immigrant badgers bringing in new infection or being infected from sett contamination: the 'maintenance phase'.
- Operations were costly and took an *average of 25 months* (epidemiological investigation of breakdown, period to delineate social groups, sample results awaited, extent of clearance, new herd breakdowns).

1986 to date – Interim strategy

- An *epidemiological investigation* is undertaken to eliminate sources of infection other than badgers (see Appendix 7). A badger survey is carried out in parishes with no recent history of disease in cattle attributed to badgers and the evidence presented to the 'mini-Panel'.
- *Social groups are not defined* (no bait-marking).
- *Cage trapping* is carried out by Wildlife Unit staff: trapped badgers are shot and examined *post-mortem*; samples are cultured in the laboratory.
- Operation is limited to the *reactor land* (i.e. that part of the farm used by the reactor animals, if identifiable, or the breakdown farm if not).
- *No pre-removal sampling* is undertaken: all badgers using the reactor land/breakdown farm at the time of the removal are removed, whether or not infected.
- *Lactating sows* (whether or not infected) are released: Professor Dunnet's recommendation to destroy them was rejected by Ministers.
- *Trapping stops when there is no further sign of badger activity on the reactor land: no steps are taken to prevent recolonisation* after the operation is completed.
- Interim strategy is *quicker* than the clean ring strategy – no maintenance or monitoring phase.

1994 to 1996 – Live test strategy

- This was a *trial* of a strategy using the live test compared to an existing (interim) strategy.
- *Epidemiological investigations* were carried out to rule out sources of infection other than badgers (see Appendix 7).

- *Selection criteria* for entry into the trial had to be met, e.g. MAFF South-West Region, at risk cattle herds surrounding breakdown farm, badger activity.
- Badger investigations were *randomly allocated* to live test or interim removals.
- *Discriminatory* – it attempted to identify infected populations of badgers (setts not individuals or social groups) by survey and ELISA testing in live test areas (positive setts were removed).
- *Operations extended beyond the breakdown farm* to adjacent farms with cattle herds at risk from the same badgers which had caused the index breakdown.
- *Lactating sows* were released in all trial areas.
- *Increased staff* resources (two and a half times greater than the interim strategy).
- Carcasses were examined *post-mortem* and laboratory culture undertaken.
- *There was no revisiting to prevent recolonisation* after the operation was completed.
- This was a *longer operation* as there was a *larger area* to survey and control than in the other strategies (about 12 km²).

MAFF summary of action taken in response to the Dunnet review

Dunnet terms of reference

'To conduct an overall review of the problem of dealing with badgers infected with bovine tuberculosis insofar as it affects the eradication of the disease in cattle, taking into account changes in the field and research since Lord Zuckerman reported on the problem in 1980.'

Summary of recommendations

(i) the objective of the policy on bovine tuberculosis and badgers should be to limit the transmission of disease from badgers to cattle by dealing with identifiable and avoidable risks, quickly and effectively at a reasonable cost (paragraph 106);

(ii) when a diagnostic test in living badgers is available, the procedures for badger control be changed to discriminate between infected and healthy badgers (paragraph 118);

(iii) with the flow of additional data becoming available from research and badger removal operations, the Ministry keeps the policy and strategy on bovine tuberculosis and badgers under continuous review (paragraph 143);

Action taken by MAFF

Accepted.

A diagnostic test in living badgers has been developed but, because of its relatively limited ability to identify infected individuals, it has not been possible to adopt it in place of the 'interim strategy'. A trial comparing the interim strategy with one incorporating the test began in November 1994 in South-West England but was suspended in December 1996 pending the outcome of the Krebs Review.

Accepted. The introduction of the live test strategy was an example of this process of review.

Summary of recommendations

(iv) for the time being, action should be taken against badgers only after a herd breakdown, for which no other source of infection can be found, in areas of the country where there has been a recent history of herd breakdowns which have been attributed to infected badgers (paragraphs 108 and 109);

(v) in such circumstances as defined in recommendation (iv), the badgers using that part of the breakdown farm where it is believed that the disease was transmitted to cattle, or the whole farm if it is not possible to be more precise, should be captured, killed humanely and examined post mortem, without prior sampling or delineation of social groups, and with no question of extending the operation beyond the breakdown farm (paragraph 110);

(vi) in the context of these more limited badger removal operations, the current practice of releasing lactating female badgers should be discontinued (paragraph 111);

(vii) the Ministry undertakes the necessary consultations with a view to placing before Parliament a revision of the Badgers (Control Areas) Order 1977, with statutory Control Areas in which (a) there has been a recent history of herd breakdowns attributed to infected badgers and (b) the Ministry would propose to undertake badger removal operations automatically in the advent of future otherwise unexplained herd breakdowns (paragraph 112);

Action taken by MAFF

Accepted. Badger removal operations are undertaken only on this basis.

Accepted and implemented.

Not accepted.

The 'control areas' have been superseded by Type I parishes (i.e. parishes and communities in which there has been a badger-related breakdown within the previous six years). In these parishes, badger removal operations may be approved by senior veterinary staff.

Summary of recommendations

(viii) outside of the revised statutory Control Areas, the Ministry should consider taking action against badgers only after (a) two or more otherwise unexplained herd breakdowns have occurred in close proximity and (b) seeking the advice of the Consultative Panel on Badgers and Tuberculosis (paragraph 109);

(ix) the Ministry keeps the interim badger control strategy under continuous review, and, in particular, reconsiders it if (a) no infection is found in the badgers removed in a significant number of cases, or (b) there is evidence of a significant increase in herd breakdowns (paragraphs 110 and 113);

(x) the Ministry continues to undertake by the use of live trapping such badger operations as are justified and provides adequate resources to ensure that operations are undertaken with the minimum of delay (paragraphs 114 and 115);

(xi) the Ministry encourages farmers to seek to prevent (a) cattle having access to badger setts and (b), as far as possible, badgers and cattle eating from the same food source (paragraph 126);

Action taken by MAFF

In Type II parishes (no badger-related breakdowns in the past six years), the advice of a subgroup of the Consultative Panel is sought before a badger removal operation is commenced.

All badgers killed under the 'interim strategy' are examined *post-mortem* and samples taken for laboratory culture. The results show a high prevalence of infection with *Mycobacterium bovis* in such badgers. The increase in herd breakdowns was one of the reasons for the convening of Professor Krebs' Review.

Accepted, although there are delays in badger control operations.

A leaflet on keeping badgers and cattle apart is given to farmers whose herds suffer TB breakdown. This leaflet is being extensively updated at present.

Summary of recommendations

(xii) with a view to discriminating between healthy and infected living badgers in any future badger operations and as an aid to other research, the Ministry should transfer resources from other areas of the programme to seek to speed progress in developing a diagnostic test in living badgers, and consider using different laboratories for the different stages of the work (paragraphs 119 and 120);

(xiii) the field studies of badger population biology and transmission of tuberculosis being undertaken at the Ministry's Gloucestershire study area should continue for at least another five years. The facilities there be made adequate for such work to be developed and conducted effectively. In the event of a herd breakdown in the study area, adequate compensation terms be available to the farmer(s) concerned so that the continuance of the programme can be ensured (paragraph 132);

(xiv) the Ministry seeks ways of obtaining information about the reproductive biology of the badger and the relationship between the age of badgers and the incidence of the disease, from the badger carcasses which become available to them (paragraph 137);

(xv) the Ministry allocates additional resources to develop modelling studies of the epidemiology of tuberculosis within badger populations and its transmission to cattle (paragraph 139);

Action taken by MAFF

Accepted and implemented.

Accepted and implemented. The terms of compensation for farmers within the study area, and the numbers of farmers benefiting, have been improved.

Research has commenced on this.

Three separate groups are currently undertaking population modelling work, some of which is being funded by MAFF.

Summary of recommendations

(xvi) the Ministry undertakes further statistical studies designed to elicit and explain the observed time paths of tuberculosis incidence in cattle herds on a national and appropriate regional basis (paragraph 140);

(xvii) the Ministry pursues alternative sources to the agriculture budget for the funding of elements of the research programme on bovine tuberculosis and badgers (paragraph 141);

(xviii) the Ministry considers if aspects of the research programme on bovine tuberculosis and badgers could be effectively conducted by other institutions and laboratories at a lower cost than if they were conducted 'in house' (paragraph 142);

(xix) the Ministry makes available adequate resources to allow collection and analysis of the data arising from the interim badger control strategy (paragraph 114);

(xx) the Ministry continues, through publicity, to encourage members of the public to notify them of the location of badger carcasses (paragraph 135);

(xxi) when a diagnostic test in living badgers is available, sampling be undertaken throughout the country to seek more detailed evidence of the distribution and incidence of tuberculosis in badgers (paragraph 135);

Action taken by MAFF

Statistics are collated on a continuous basis, and a database has been set up connected to the animal health computer system (VETNET). Statistical studies have been funded continuously in the Epidemiology Department of the Veterinary Laboratories Agency (VLA).

This has not so far been pursued.

Outside contractors are involved in very limited aspects of the research programme.

Accepted and implemented. Analysis of the data has been undertaken by the VLA.

The national survey of badgers killed in road traffic accidents (RTAs) continued until August 1990 but was then suspended. RTA badgers continue to be investigated in high risk areas.

Not implemented. The low sensitivity of the live test precludes its use for detecting all infected badgers individually.

Summary of recommendations

(xxii) the Ministry encourages initiatives to improve the data on the distribution and density of badger populations, perhaps with some financial support (paragraph 136);

(xxiii) the Ministry continues to take such opportunities as arise to examine wildlife, other than badgers, for tuberculosis, and particularly continue with their investigations into the possibility that there may be a reservoir of the disease in deer in parts of the country (paragraph 42);

(xxiv) the Consultative Panel on Badgers and Tuberculosis be kept in being, but that its terms of reference be amended to reflect the objective of the policy set out in recommendation (i) (paragraph 145);

(xxv) the Ministry and the Consultative Panel consider jointly whether any changes could be made usefully to (a) the Panel's composition, (b) the detail and confidential treatment of Panel papers, (c) the structure of Panel meetings and (d) the public reporting of the Panel's meetings (paragraph 146);

(xxvi) the liaison officers appointed by the County Naturalists' Trusts develop their role as a two-way channel of communication between the Ministry and conservation organisations on this subject. The Ministry make all the efforts that it can to keep those liaison officers informed of relevant events (paragraph 147);

Action taken by MAFF

MAFF has encouraged the improvement of such data, but has not made funds available for this purpose.

Deer surveys have been undertaken in the Mendips and in Herefordshire during the past three years. Attempts have been made to survey mink in Wales.

Accepted and implemented.

New groups previously unrepresented (e.g. the Women's Farming Union) are now included in the Badger Panel. However, the minutes of Panel meetings are not published.

Liaison tends to be with local badger groups rather than County Naturalists Trusts.

Summary of recommendations

(xxvii) the Ministry adopts a more positive approach to informing the public on this subject, perhaps by the more frequent use of press releases and press conferences (paragraph 149);

(xxviii) the Ministry participates in public discussions of the problem, particularly in scientifically-based meetings and seminars (paragraph 150);

(xxix) the Ministry continues to publish editions of their series of reports on 'Bovine Tuberculosis in Badgers' on an annual basis, at least for the duration of the interim strategy (paragraph 151).

Action taken by MAFF

There is fairly frequent press interest on this subject to which MAFF responds.

A scientific seminar at the QEII Centre was organised by MAFF in 1994. Meetings with interested MPs were organised at the House of Commons in 1993 and 1995. Other interested bodies have been briefed, including the National Farmers' Union and the British Veterinary Association.

Accepted and implemented.

Source: MAFF

Bovine TB in other countries and information on badgers and other potential wildlife vectors

COUNTRY	CATTLE		BADGERS AND OTHER POTENTIAL WILDLIFE VECTORS		
	Number (millions) (year) (1)	TB incidence (% of herds affected) (1) & (3)	Species and population size (2)	Prevalence of infection (2)	Culling policy/ Remarks (2)
EUROPE					
Great Britain (5)	11.9 (1996)	471 new confirmed outbreaks (1996) (0.41% herds) – mainly SW England & South Wales	Badgers: 250-400,000 adults Deer: < 100,000	13.7% (road accident casualties – 1996) up to 75% in problem areas 1-2% (maximum 4%) in carcasses examined	Protected species; national control measures implemented by Government staff; cage trapping on breakdown farms Farmer control
Northern Ireland	1.65 (1996)	1,232 outbreaks (2.79% herds) (some breakdowns disclosed at slaughter)	Badgers: 50,000	n/k	Protected species; no official culling programme
Republic of Ireland	7.423 (1996)	8,867 outbreaks (estimated 3.74% herds)	Badgers: 200,000	14.3% (average between 1980-1991)	Protected species; no national control programme; farmer advice to prevent transmission
Austria	2.272 (1996)	5 outbreaks (1996) – incidence 0.002% herds (1994)	Badgers: 30,000	n/k	Regarded as small game – hunting permitted. No evidence of involvement in cattle breakdowns
Belgium	3.159 (1996)	43 outbreaks (1996); 0.025% herds restricted in 1992	Badgers: 3,000	n/k	Protected species, suffered during rabies control. Poisoning and snaring continues illegally. No evidence of involvement in cattle breakdowns
Bulgaria	0.632 (1996)	3 outbreaks (1996)	Badgers: 35,000 (early 1980s)	n/k	Hunting permitted; no evidence of TB
Czech Republic	1.90 (1996)	Not reported in 1996, 4 outbreaks in 1992 (<i>human disease still occurs in children</i>)	Badgers: 21,000	n/k	Hunting by dogs for sport and meat; not protected; no evidence of TB
Denmark	2.09 (1996) (<i>667 farmed deer herds</i>)	Last reported in 1988 (<i>14 farmed deer herds (67 deer) infected between 1988-1992; last infection 1994</i>)	Badgers: 25,000	n/k	Hunting permitted (closed season) – shooting
Finland	1.15 (1996)	In 1894 25% of tested cows were tuberculous; 67 infected herds by 1937; last infection 1982	Badgers: 40-60,000 minimum	Bovine TB has never been recorded in badgers or any other wildlife	Hunting permitted (closed season for sows with cubs)

COUNTRY	CATTLE		BADGERS AND OTHER POTENTIAL WILDLIFE VECTORS		
	Number (millions) (year) (1)	TB incidence (% of herds affected) (1) & (3)	Species and population size (2)	Prevalence of infection (2)	Culling policy/Remarks (2)
France	19.15 (1996)	25% herds infected (1955); 0.3% by 1992; 0.14% by 1996	Badgers: 80,000	Surveillance programme has not identified TB in badgers or any other wildlife	Hunting permitted as small game (closed season). Poisoning, snaring, trapping illegal; gassing used in 1970s for rabies control
Germany	15.68 (1996)	99.7% certified officially TB-free (1961). None recorded in 1996 but 5 affected districts in 1995	Badgers: 72,000 +	n/k	Hunting permitted; rabies control reduced populations; no evidence of TB recorded
Greece	0.536 (1996)	167 outbreaks (1996); enzootic, confined to certain regions	Badgers: (population n/k)	n/k, but unlikely to pose a problem	Legally protected but persecuted; low numbers are estimated; probably endangered
Hungary	0.910 (1996)	One outbreak (1996); 1988-1993 – 35 outbreaks (<i>widespread human disease; believed to be responsible for infecting cattle</i>)	Badgers: 20,000	n/k	Protected since 1974; rabies control may affect numbers
Italy	6.34 (1996)	2,186 outbreaks in 1996; 1.16% in controlled herds	Wild boar: (population n/k) (3) Badgers: (population n/k)	Tuberculous lesions in 300 out of 2,500 carcasses (1995/96) (3) n/k (no surveillance programme for bovine TB in wildlife)	No official culling policy (3) Protected species
Luxembourg	0.22 (1996)	Not reported (1996); last confirmed case in 1964	Badgers: 2,000+	No evidence of disease found	Protected species
Netherlands	4.55 (1996)	One outbreak (1996); infection rate 17.4% in 1949	Badgers: 2,200	n/k	Protected species; surveys show 606 setts
Norway	1.00 (1996)	Last outbreak in 1986	Badgers: 45,000 minimum	n/k	Not protected, regarded as pests; abundant. Shot/cage trapped for sport
Portugal	1.26 (1994)	0.04% of 906,935 animals tested (1996)	Badgers: (population n/k: 'fairly common')	No evidence disease spread by badger population	Protected species since 1986; not threatened
Spain	5.00 (1994) (FAO figures)	> 0.2% (most of country > 2.00%)	Badgers: (population n/k)	n/k	Protected species
Sweden	1.79 (1996)	Officially TB-free in 1958. 10 tuberculous bovine herds between 1968-1978 (<i>Since 1991, 13 infected farmed deer herds out of 570</i>)	Badgers: >250,000 Elk: (population n/k)	Hunted around TB infected farmed deer herds – no infected badgers found so far. 2 cases diagnosed in 1940s – the only cases of bovine TB detected in wildlife	Normal hunting permitted 1 August to 15 February: specific rules for protective hunting

COUNTRY	CATTLE		BADGERS AND OTHER POTENTIAL WILDLIFE VECTORS		
	Number (millions) (year) (1)	TB incidence (% of herds affected) (1) & (3)	Species and population size (2)	Prevalence of infection (2)	Culling policy/ Remarks (2)
Switzerland	1.75 (1996)	2 outbreaks (1996); infection rate 50+% (1951); >99.8% officially TB-free (1959) Sporadic cases due to imported human disease/ recrudescence in elderly	Badgers: 7,500 minimum	No infected badgers found in last 20 years	Hunting permitted July to January
OCEANIA					
Australia	25.7 (1996)	6 outbreaks in cattle (1996); 2 buffalo	Feral buffalo: (population n/k) (3)	2% of buffalo tested as reactors (3)	Area control by shooting - 200,000 destroyed in Northern Territory (3)
New Zealand (4)	9.27 (1996)	866 outbreaks (1996); 1979 – 79% of 40,000 herds accredited; 2.7% cattle herds restricted in 1991; 2.4% in 1994 on movement control; herd incidence 0.39% (low risk), 8.3% (high risk) (3.9% <i>farmed deer herds restricted in 1991</i> : 4% (1994); herd incidence 0.7% (low risk), 9.5% (high risk)	Possums: about 70 million Ferrets: (population n/k) Hedgehogs: (population n/k) Feral cats: (population n/k) Stoats: (population n/k) Feral pigs/deer: (population n/k)	Average 5% (12% infected on West coast of S. Island) 17.9% (548 animals sampled – Otago); 15.5% (84 animals sampled – MacKenzie Basin). Up to 66% infected on infected properties (4) 4/79 (5%) infected in one survey 0.9% Otago (0.12-3.6 at 95% confidence indicator), 2% (50 animals sampled – MacKenzie Basin)(4) 1.6% (in some properties up to 8.95% infected)(4) n/k	National control programme by poisoning etc – considered main vector to domestic livestock Associated with infected cattle herds – may be a reservoir host for domestic livestock Scavenger on possum carcasses, itself eaten by ferrets/pigs; unlikely to be self-maintaining Spillover host only – unlikely to transmit to cattle; scavenge on carcasses Probably spillover hosts from possums; may transfer infection to possums in new areas
THE AMERICAS					
Canada	14.4 (1996) (121,000 herds)	One outbreak (1996) (<5 breakdowns/annum since 1987)	Bison: 2,400 (3)	<50% (3)	No official culling policy (3)
AFRICA					
South Africa	11.35 (1996)	5 outbreaks (1996); positive herds 0.014% (24 herds) in 1993	African buffalo: (population n/k) (3)	90% of herds infected south of Sabie River, 50% to north (source from infected cattle herds) (3)	2 cases 1990, surveys conducted; spillover into cheetah, lion, greater kudu, baboons (3)
Uganda	5.36 (1996)	Prevalence is 1.6% (incidence varies from 0.01% to 30% depending on region)	Buffalo, warthogs: (population n/k) (3)	5 out of 13 buffalo <i>M. bovis</i> positive; one case in warthog (3)	

COUNTRY	CATTLE		BADGERS AND OTHER POTENTIAL WILDLIFE VECTORS		
	Number (millions) (year) (1)	TB incidence (% of herds affected) (1) & (3)	Species and population size (2)	Prevalence of infection (2)	Culling policy/ Remarks (2)
ASIA					
Taiwan	0.15 cattle (1996); 0.013 (buffalo) (only 2,600 dairy cows in 1958) (50,000 farmed deer reared annually)	53 outbreaks (25 confirmed infected – 1996) mainly large dairy herds/draught cattle <i>(First confirmed TB in farmed deer 1984; 1987 survey showed 3.15% infection rate (60/1900))</i>	n/k		

References:

- (1) O.I.E. 1996.
- (2) Griffiths and Thomas 1993.
- (3) Thoen and Steele 1995.
- (4) New Zealand Veterinary Journal 1995.
- (5) MAFF published papers: CVC's report 1996; Bovine tuberculosis in badgers, annual reports by MAFF.

New unconfirmed herd breakdowns

(a) 1987 to 1991 (inclusive)

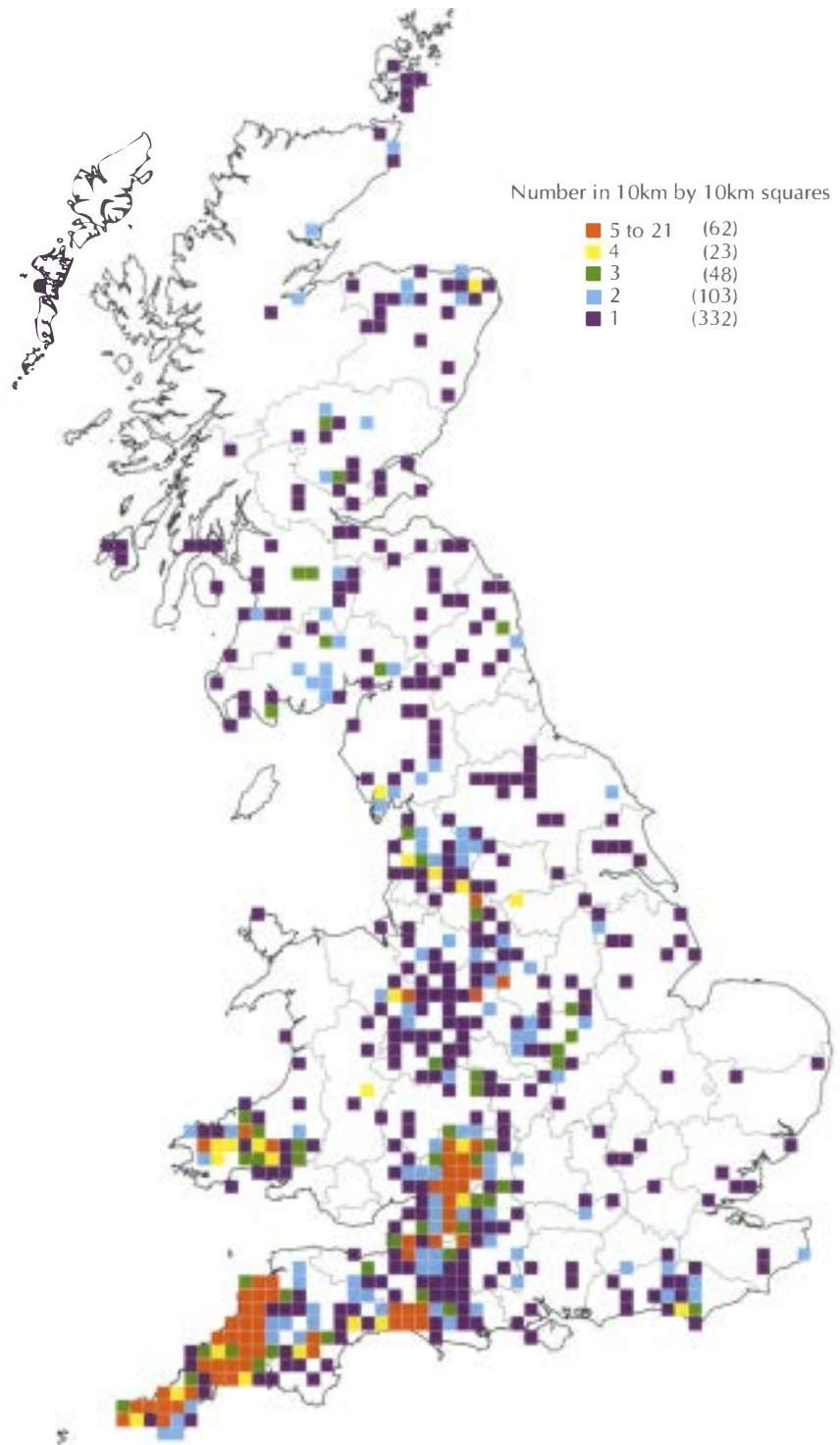

(b) 1992 to 1996 (inclusive)

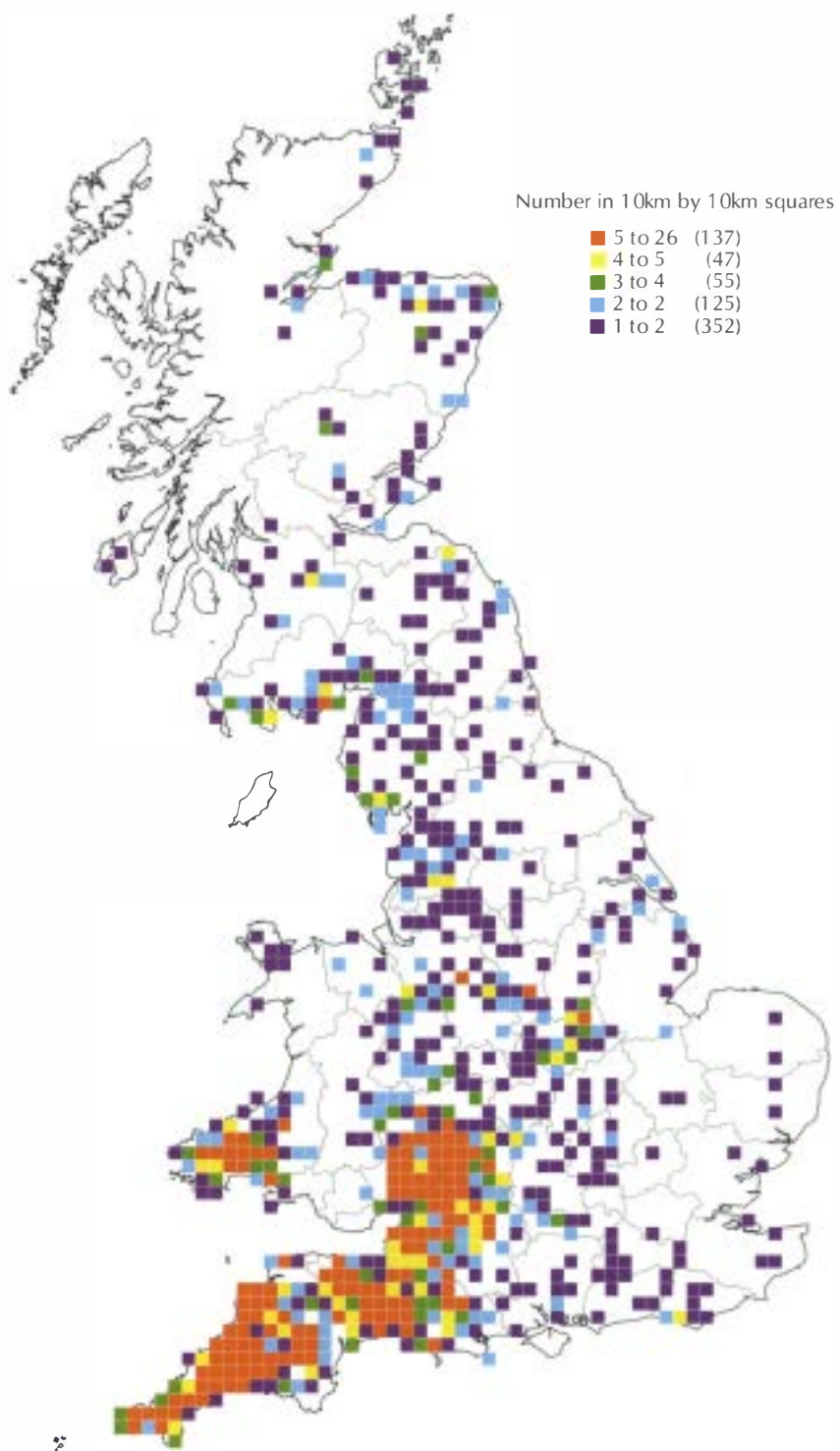

MAFF protocol – assessment criteria for determining the cause of a herd breakdown

1 Introduction

1.1 The objective of the epidemiological investigation is to find the origin of tuberculosis infection and to determine what further action may be necessary to contain it. In order to do this, it is firstly necessary to assess when and where the reactors or other infected animals became infected, so that the extent of further action can be evaluated. This may require the tracing of animals moved onto the premises and the subsequent testing of traced animals and animals in contiguous herds. It is only when the possibility of cattle-to-cattle infection or the introduction of infected purchased animals have been eliminated that the status of wildlife is considered.

1.2 Infection is invariably derived from another mammal, most likely cattle or badgers but also possibly humans or deer, or rarely from other domesticated species or wildlife. It is important that veterinary officers carrying out an epidemiological investigation approach this in a logical and methodical manner, and proceed to an investigation of wildlife sources only when all other avenues of investigation have been discounted.

2 Assumption

2.1 For the purposes of this paper, it has been assumed that the cattle breakdown is confirmed by the presence of either a visibly lesioned animal with or without laboratory culture of *M. bovis* or an animal with no lesions but with a positive culture result.

3 Cattle history

3.1 The herd file must be examined to see if there has been a history of a previous breakdown on this farm and what was the likely origin of such an infection. It is important to note whether there are or have been other breakdowns in the locality, as they may be connected with each other, e.g. nose-to-nose contact. If the current herd test is not a routine test, then the file may indicate a possible origin of infection. The herd may only recently have been purchased or moved onto the premises so the testing history may be unknown to the present owner; however details should be held in the previous owner's file. Furthermore, the farm may have changed farming practice lately, e.g. from arable to beef, so no previous cattle history will be available.

4 On the farm

4.1 In order for the veterinary officer (VO) to carry out an epidemiological investigation, it is necessary to carry out a farm visit. The VO will need to be conversant with the herd history through the herd file, have the details of the post-mortem

examination, any previous treatments, and access to the on-farm and movement records as well as a farm map. A map of the area showing previous cattle breakdowns in the vicinity is also most useful. The epidemiological examination should comprise the elements set out below.

Farm management

4.2 The following information should be recorded:

- the farm type, i.e. dairy, beef suckler, bull beef etc, and the farmer's system of management – this is important for determining the likelihood of spread within the herd if there are multiple reactors;
- basic farm policy, i.e. breeding policy (e.g. hired bull, artificial insemination), fate of calves, replacement policy (e.g. home-bred or purchased), cull cows, fattening stock;
- for beef herds, whether calves are double or multiple suckled, and how they are grouped;
- in dairy herds, whether cows are divided into groups, e.g. dry cows separated from milking cows, high and low yielders, heifers and young animals; how groups are managed during the grazing, housing and whether the groups are kept separately;
- whether there are any off premises and the stock normally move between premises;
- whether the cattle are housed in the winter, and if so which groups and for how long – record the dates when animals were housed;
- type of housing, and whether the cattle have access to the outside during their period of housing – may be very significant if the buildings appear to be relatively wildlife-proof;
- distribution of the group containing the reactor during the previous two years, i.e. which fields they grazed and when;
- conservation policy for hay and silage.

History of reactor

4.3 The complete life history of the animal (or animals) reacting to the tuberculin test must be obtained. This is especially important during the period from two months before the penultimate herd test to about two months before the test at which the animal reacted for the first time. This is because the tuberculosis reactions and lesions generally take about 60 days to develop – although it is possible they may develop more quickly than this. If the animal was an inconclusive reactor prior to becoming a full reactor, then it is probably safe to assume that it was infected before the herd test at which it was first detected.

4.4 The origin of the reactor(s) should be obtained to determine whether home-bred or purchased, and how long they have been in the herd. For a young animal or group of young animals that have reacted, the date of birth should be known (congenital infection is not unknown), including its management since birth, e.g. the date when it (they) first went out to grass, when it was housed and for how long and whether the accommodation was badger-proof as sick badgers often enter farm buildings to acquire food.

4.5 For the cow(s), the following details need to be determined:

- the calving dates – these may be important because dry cows may be kept in a separate group, or housed/grouped separately after calving;
- whether high and low yielders;
- whether the cattle are tied by the neck, as reactors may be related together by their position in the standings;
- nose-to-nose contact – groups of cattle may be related to the locations where they were on the farm, and the position of contiguous herds. The farmer is asked to assist with this by reference to maps of the farm. It is also necessary to determine the fields grazed by the reactor(s) during the relevant period in case of future badger investigations, and may include hay/silage aftermaths and even farm lanes used to get to outlying fields.

4.6 Apart from the history of the reactor, the previous testing history should be established and any illness, treatments and medication used.

Contamination

4.7 The positions of sewage outfalls, caravan parks, old drains and lay-bys are ascertained. These are rarely a problem unless there is farmhouse effluent or a human source of infection to which the cattle have access. The availability of a clean water supply and the means of slurry/dung disposal should be investigated. 'Natural' fertilisers may be significant as may the presence of contractors using the land.

Reactor cattle or group

4.8 Information on the disposition of the herd or group at various times may well be required in multiple outbreaks. The reactors may have been in one group, or were split up at some time, which may reveal when they became infected. Calving dates for instance may indicate when heifers left the group to calve down. Batching of cattle following the movements of individuals within the herd may show the occasions when they were all together in the same place at the same time.

4.9 Multiple reactions at a single test may arise either by independent infection from a common source or from within-herd spread, i.e. 'open' cases. The post-mortem findings may assist in determining this, although such cases are usually due to at least one 'open' lung case, particularly where a single reactor group is involved. If several

unconnected groups are infected at the same time, this *may suggest* a wildlife source. If multiple reactors were all purchased from different farms, infection probably occurred on this premises. Anergic animals (those which are infected with TB but are not sensitised to tuberculin, i.e. are 'false negatives' on the skin test) are sometimes postulated as the cause of multiple reactors, either at one test or during an extended outbreak. At post-mortem examination or during routine meat inspection, such animals will normally display extensive lesions in the lungs. These findings are however uncommon.

4.10 Information about the housing of animals is important for two reasons:

- (i) cattle are less likely to become infected from wildlife when housed, and
- (ii) if there are lung cases, the disease is more likely to spread between cattle when they are in a confined environment.

The dates when the animals were housed and turned out during the last year, and the year before, need to be considered in relation to seasons and the likely persistence of *M. bovis* on the ground.

Other domestic animals on the farm

4.11 Other domestic species are a possible source of TB. Sheep have been identified as *M. bovis* positive in New Zealand and one case has been identified in sheep in Devon. TB has occasionally been found in farm cats and dogs, caught from the infected cattle. Human infection may rarely be transmitted to cattle and other species. Infection in goats and pigs, and especially deer, may well require additional measures to be taken such as testing and further restrictions.

Public health risk

4.12 Human TB due to *M. bovis* is rare but nevertheless enquiries should be made about the health of anyone in contact with the infected cattle, particularly if they have any suspicious chronic diseases. *M. bovis* infection can be located almost anywhere in the body, although the lungs are most commonly affected where aerosol spread from infected cattle has occurred, usually during periods of housing. These occasions are very rare.

4.13 Any risk to humans from the cattle will not be known until after the post-mortem examination. Where disease is confirmed in the cattle, either at post-mortem or in the laboratory, the local Consultant in Communicable Disease Control (CCDC) is notified. The Environmental Health Department are also informed so that they can take any necessary action to protect public health, e.g. the service of Heat Treatment Orders in respect of milk.

Purchased animals (movements on)

4.14 Purchased cattle are not significant if the reactors are not purchased. Other cattle moving onto the premises would have been tested with the herd, and presumably passed. If they have moved off the farm again, they should be recorded in the

movements off and will have to be traced and possibly tested, and if considered to be dangerous as contacts, they may be slaughtered. If they have gone to an abattoir or knackery, then any visibly-lesioned cattle disclosed at meat inspection will be reported and clinically sampled.

4.15 If purchased animals are present as reactors, the date they were brought onto the premises has to be confirmed. If the animals were present on the farm for less than two months, then they were probably (but not absolutely certainly) infected elsewhere. If they were purchased more than two months before the last test, then they may have become infected on this premises.

Movements off

4.16 Although it is sometimes difficult to know how far back to trace movements off, this usually covers the whole period to two months before the last clear herd test. If all the stock on the farm are said to go direct for slaughter, this is confirmed with the slaughterhouse. The extent of tracing required will not be known until after the post-mortem examination is completed and the likelihood of disease spread assessed in the light of the findings. Some movements which may not have been entered in the movement book, for example hired bulls, contract reared animals, animals belonging to relations and those at summer grazing, must also be traced. In confirmed cases where traced animals have been exported, Export Section at Tolworth are informed.

Contiguous premises

4.17 The names of all neighbours that adjoin the land must be identified on the map, particularly if there is nose-to-nose contact with reactor cattle, commonly along rivers and streams where the cattle drink. The possibility of straying by either the reactor herd or by contiguous cattle must be eliminated, as must the possibility of contact with other herds at summer or common grazing. All possible contacts must be tested, even if herd tests have to be brought forward. The results of post-mortem examinations will also be taken into consideration when assessing the degree of spread within and between herds, and the level of tracing and testing required.

5 Wildlife history

Wildlife using farm

5.1 If the previously detailed investigations have not identified a likely source, a wildlife origin should be considered. Farmers do not always notice badgers on their farms as the badger is nocturnal, nor are signs of badger activity such as latrines and runs always seen. Enquiries are made as to whether there have been any apparent changes in the badger population recently, and if any sick looking or dead badgers have been seen around the farm, in the fields or the buildings, or any badgers have been seen during the day. Buried carcasses may be exhumed if the badger thought to have caused the problem died on the farm and was buried by the farmer.

5.2 The activity of other wildlife such as deer, foxes and small mammals must be noted, also the numbers present. Infection is apparently rare, but any opportunities to collect specimens of other wildlife for TB examination should be taken. Game keepers and Forestry Rangers may be able to collect samples or carcasses for the investigation. It should be remembered that foxes and several other mammals have over the years been identified with *M. bovis* infection, although usually considered to be an end host and hence not a hazard.

6 Conclusions

6.1 After completing the investigation, a probable origin should present itself. Only a limited number of probable origins are allowed to be officially recorded. These are laid out in working instructions as follows:

Purchased – only a probable origin if the animal was recently purchased or has been purchased and housed, or arrived on the premises within two months prior to the previous herd test, and where infection has been identified on the farm of origin.

Contiguous infection – only likely if an open case has been in an adjacent field and nose-to-nose contact is possible, or there has been straying. An NVL reactor on a contiguous premises is unlikely to be the origin of the index case. If the index case has open lesions, it may have been the origin of the NVL reactor.

Human – this is extremely rare although the relevant questions are asked. If reactors grazed in sewage-treated fields or had access to sewage outfalls, suspicion may be aroused.

Irish animals – few of these occur in South-West England. Herds stocked with Irish imports are tested annually and all imports are tested 60 days post-import so this origin is likely to be obvious. Animals which have been present for some years and have tested clear previously are unlikely to be the source.

Badgers – although a common origin in parts of South-West England and South Wales, these are considered as the origin only after all other possible sources of disease have been eliminated. If infected badgers have been identified in the neighbourhood of a breakdown farm, i.e. within 2-3 km within the last four years, they may indicate a badger origin. However, cases should never be attributed to badgers unless there is substantial evidence to suggest they are the cause, e.g. an infected badger in the vicinity of the breakdown with badger activity evident on the breakdown farm in the same time period, and until all other possible origins have been explored.

Unknown – or obscure – this origin should be ascribed when there is insufficient or no evidence indicating a definitive source.

6.2 Skin TB used to be considered to be an origin as it in fact indicated non-specific infection which might have interfered with the tuberculin test. All reactors to the test are examined for this condition and recorded on the test chart.

6.3 Once the preliminary investigation is complete, if veterinary staff consider that badgers are the likely cause of the breakdown, they will draw up maps detailing the reactor land and record any evidence of badger activity found in the area, or any history of infected badgers. In type I parishes (history of badger-related cattle breakdowns in the last six years), the evidence is considered by the Grade 6 in charge of the Wildlife Unit who will consider implementing a badger removal operation. In type II parishes, the Grade 6 may request the Wildlife Unit to visit the premises to carry out a badger survey in order to obtain further evidence of badger involvement. This evidence is subsequently presented to the mini-Panel which is responsible for authorising a badger removal operation.

Source: MAFF.

Infection in MAFF-taken badgers

(a) 1975 to 1990 (inclusive)



(b) 1991 to 1997 (inclusive)



Infection in road traffic accident badgers

(a) 1972 to 1990 (inclusive)

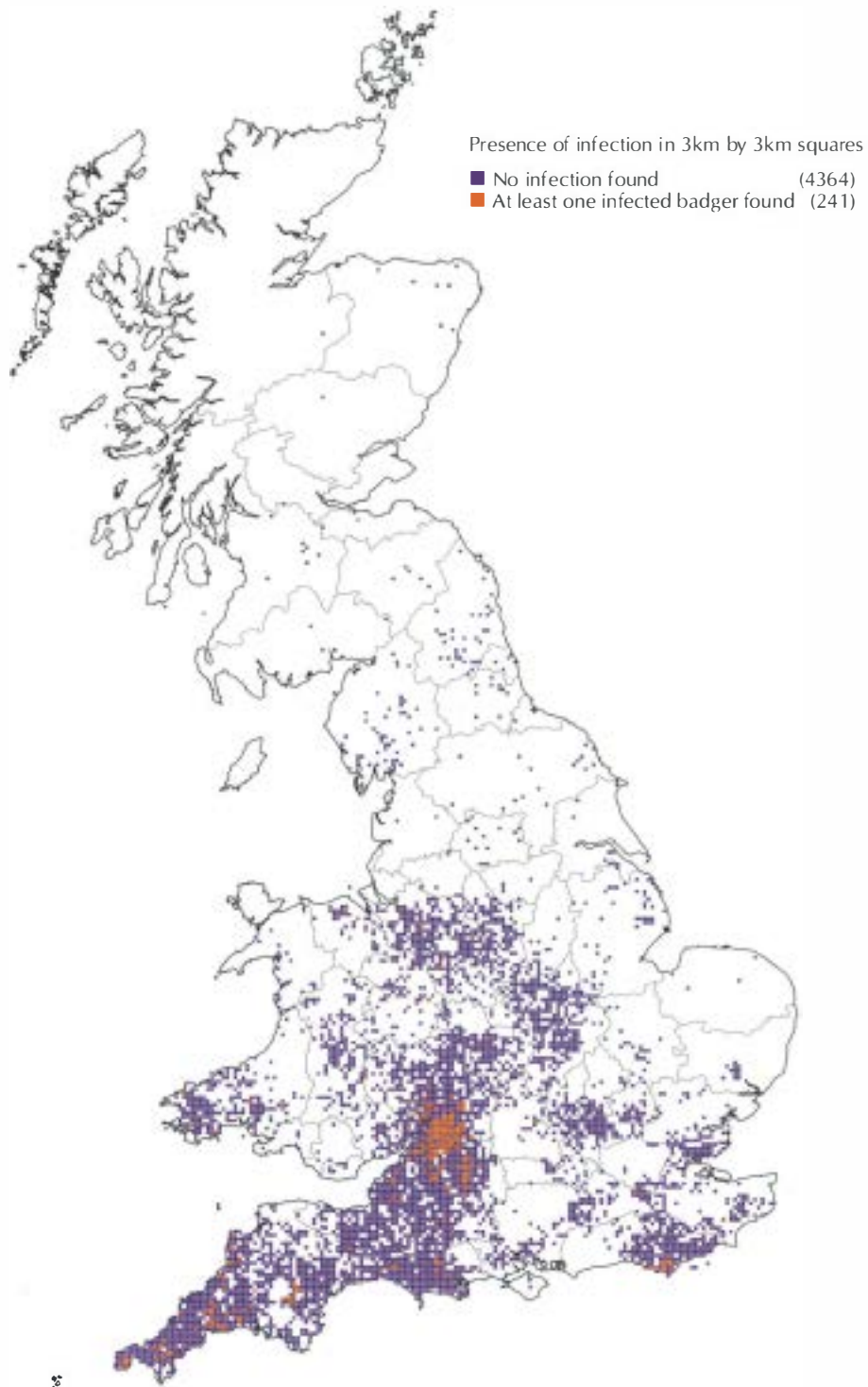

(b) 1991 to 1997 (inclusive)

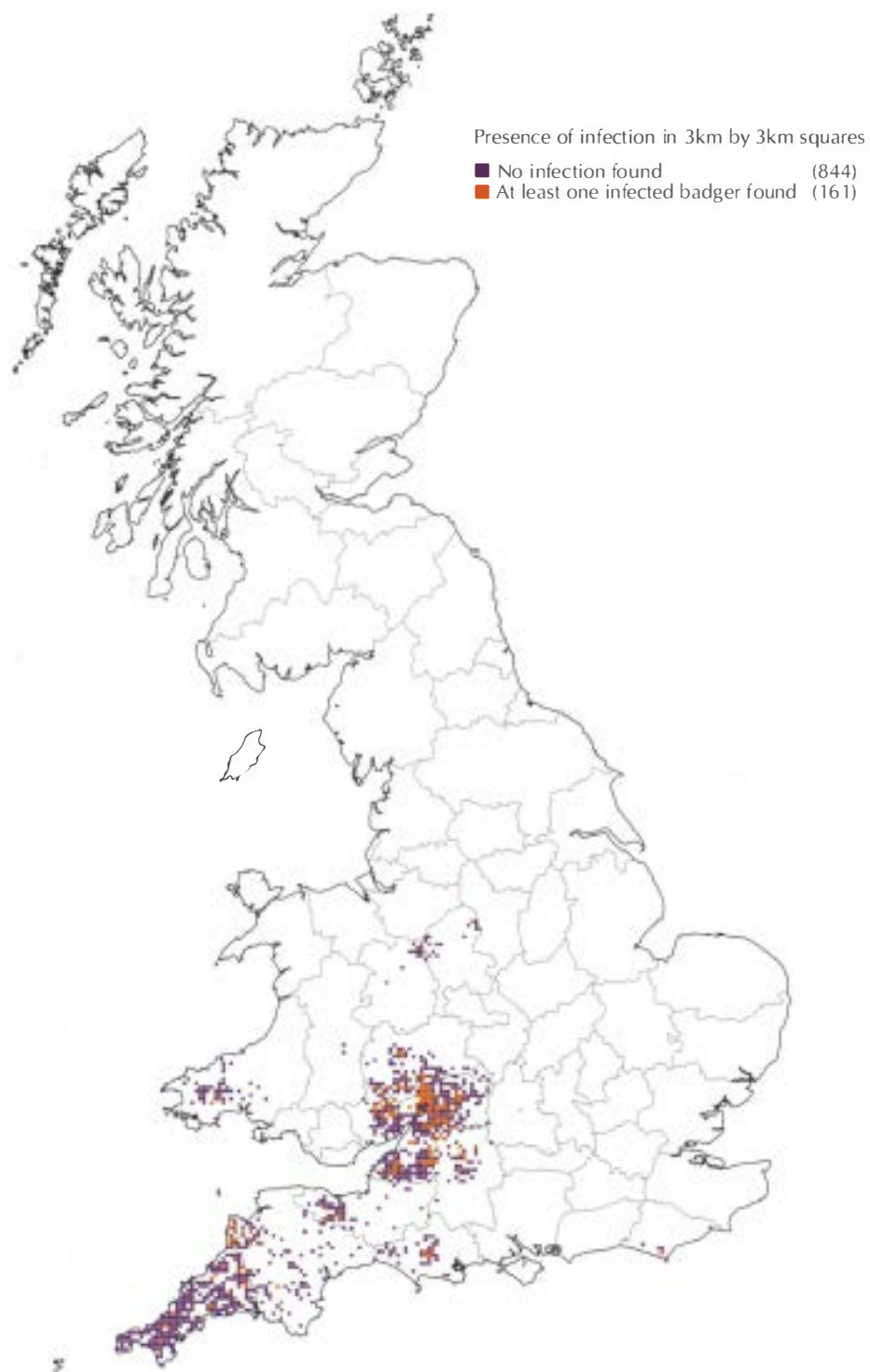

Number of MAFF-taken badgers and prevalence of *M. bovis* infection 1975 to 1996 in England and Wales

Year	Total MAFF-taken badgers sent for post-mortem	Prevalence of <i>M. bovis</i> infection in MAFF-taken badgers
1975	100	0.240
1976	203	0.158
1977	183	0.153
1978	208	0.082
1979	357	0.106
1980	346	0.095
1981	200	0.095
1982	691	0.110
1983	995	0.137
1984	1,265	0.143
1985	1,120	0.133
1986	785	0.161
1987	733	0.127
1988	778	0.272
1989	727	0.168
1990	810	0.194
1991	990	0.163
1992	1,054	0.200
1993	1,093	0.274
1994	1,708	0.224
1995	1,691	0.251
1996	2,104	0.228

Note: no badgers were taken in Scotland.

Number of road traffic accident (RTA) badgers and prevalence of *M. bovis* infection 1972 to 1996 in England and Wales

Year	Total RTA badgers sent for post-mortem	Prevalence of <i>M. bovis</i> infection in RTA badgers
1972	30	0.100
1973	78	0.205
1974	83	0.036
1975	139	0.079
1976	188	0.176
1977	173	0.064
1978	166	0.048
1979	172	0.029
1980	201	0.040
1981	442	0.054
1982	697	0.037
1983	826	0.033
1984	1,489	0.013
1985	1,498	0.024
1986	1,800	0.019
1987	1,707	0.012
1988	1,806	0.019
1989	1,817	0.025
1990	1,016	0.026
1991	184	0.027
1992	163	0.086
1993	230	0.135
1994	401	0.107
1995	485	0.101
1996	608	0.137

Note: before 1991, very few badgers were submitted in Scotland and most were uninfected. No badgers were submitted in Scotland between 1991 and 1997.

Mycobacterial strain typing

(a) DNA molecule

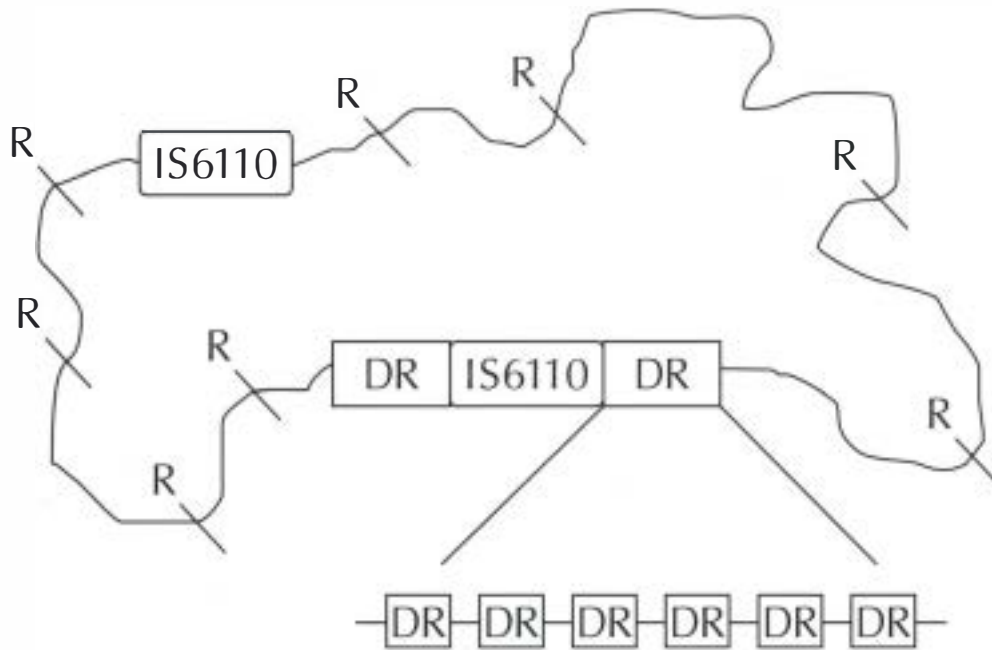

The genome of *M. bovis* consists of a single circular DNA molecule containing approximately four and a half million base pairs. The majority of its genes are identical to those in *M. tuberculosis*, and are the same in all *M. bovis* isolates. Some DNA segments are variable, however, and these can be used to distinguish different strains.

A DNA fragment known as IS6110 is present in multiple copies in the genome and is found at different locations in different strains. When DNA is cut with restriction enzymes (R in (a) above), IS6110 copies can be recovered on differing size fragments. This phenomenon, termed restriction fragment length polymorphism, or RFLP, provides the most commonly used tool for mycobacterial strain differentiation. For human TB, it has been found that, if two individuals are infected with mycobacterial strains sharing identical RFLP patterns, there is a strong likelihood that they were infected from the same index case. The number of IS6110 copies in the genome of *M. bovis* tends to be lower than in *M. tuberculosis*.

An alternative typing method is based on variations occurring in the DR region. This region of the genome comprises a series of identical direct repeat (DR) sequences interspersed with a variable set of spacer sequences. Different isolates of *M. tuberculosis* or *M. bovis* differ in the presence or absence of the variable spacers. This difference is exploited in a technique known as spoligotyping, in which the complement of spacers in an individual isolate is visualised by a hybridisation test (see (b)). By sequencing additional spacer regions from multiple isolates, it will be possible progressively to increase the discrimination provided by spoligotyping.

Rapid progress is being made in analysis of the genome of *M. tuberculosis*. The complete sequence of two *M. tuberculosis* isolates will be determined by the end of 1997. This work is leading to the identification of further variable DNA fragments that can be exploited in additional tests for strain differentiation. Some of these techniques may also be applicable in the case of *M. bovis*.

(b) Spoligotyping – an assortment of different strains from *M. bovis* isolates in Great Britain.

Also included are examples of paired isolates from cattle and badgers in Gloucester (spoligotype 17+) and in Devon (spoligotype 9*) demonstrating identical spoligotypes. The similarity between spoligotypes is shown as a percentage in the dendrogram on the right hand side of the figure.

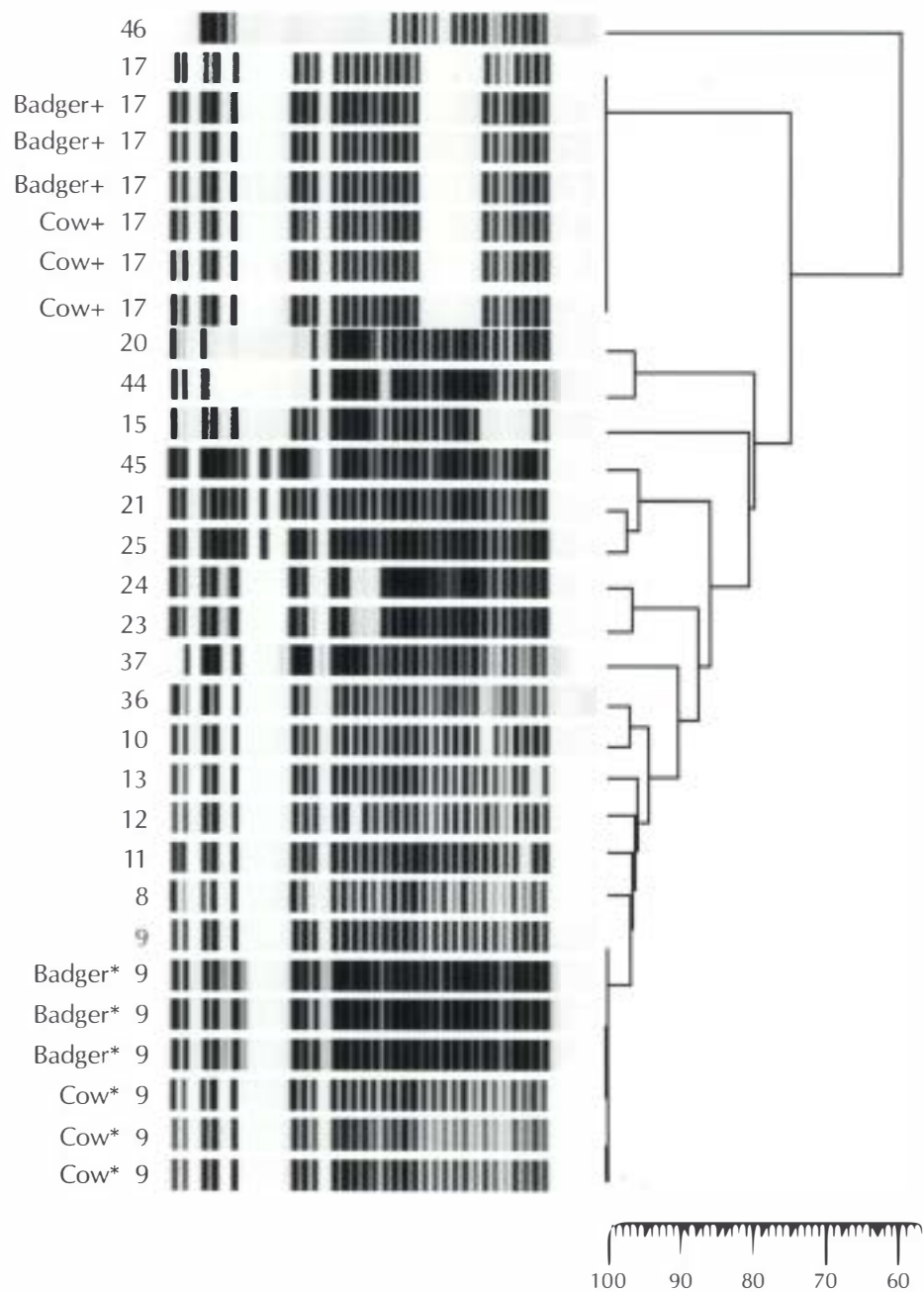

Distribution of badger spoliotypes

(a) other than 9 and 17

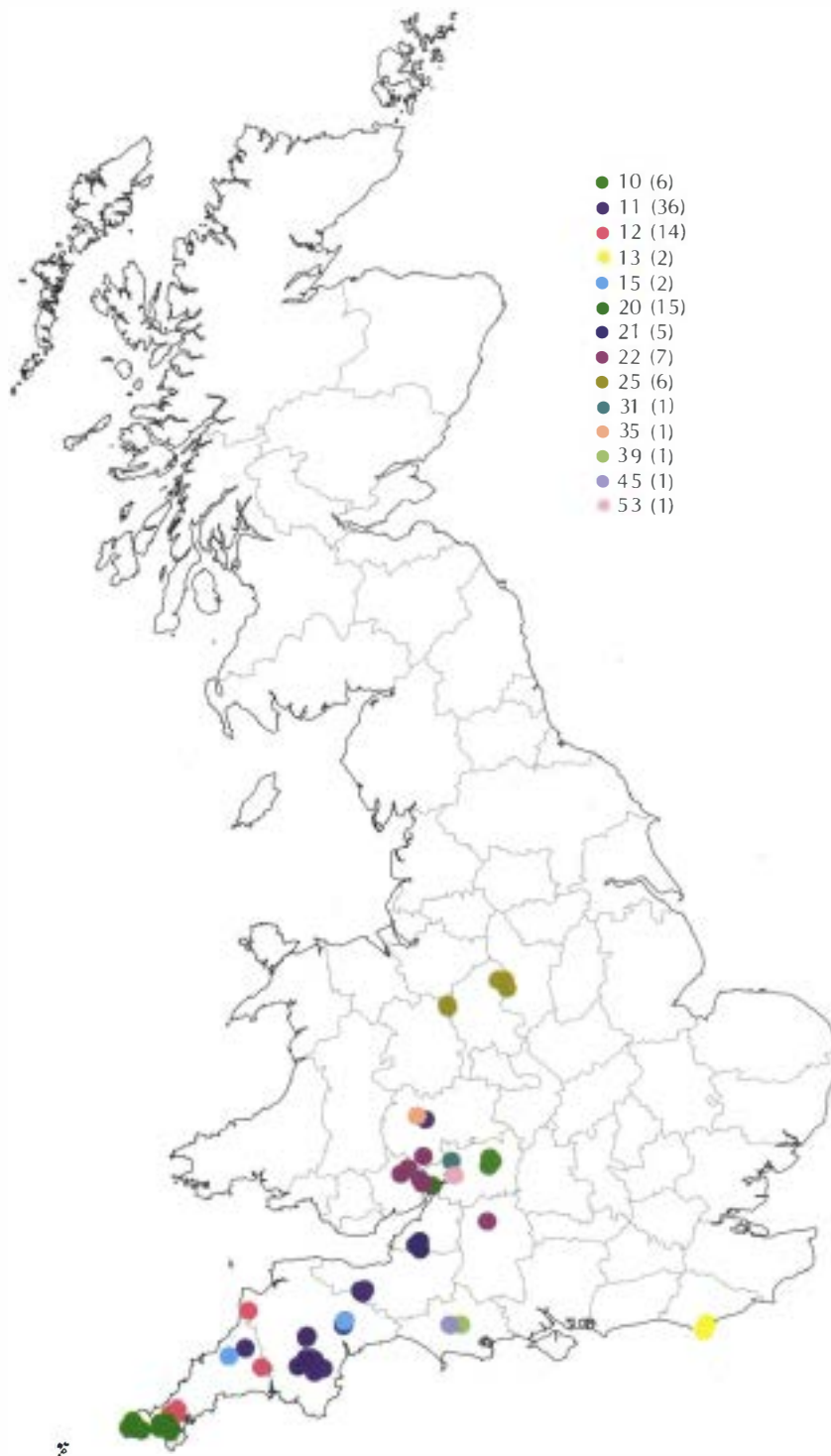

(b) spoligotypes 9 and 17



A low-cost technique for identifying social group territories

1 Several strategies for badger removal that have been implemented or proposed depend upon assigning setts to social groups by the mapping of territory borders. Failure to identify social groups greatly reduced the efficacy of the live test trial (see Appendix 15). Territory borders are usually delineated by bait-marking (Kruuk 1978), which typically takes 2-3 weeks and involves substantial staff costs. We describe below an alternative, less costly, technique which can predict territory borders with an acceptable level of accuracy.

2 Doncaster and Woodroffe (1993) showed that badger territory borders could be predicted simply from the locations of main setts, using the method of Dirichlet tessellations. These describe convex polygons, each containing one main sett and having the property that every point within a polygon is nearer to that main sett than it is to any other. The tessellations are all segments of the perpendicular bisectors of lines joining each main sett to its neighbours. The size and shape of each hypothetical territory is thus defined by the position of its main sett in relation to those of its neighbours. The locations of territory borders predicted by the tessellation method give good agreement with the known borders determined by bait-marking, for several badger study sites in Britain (e.g. Figure 1; Doncaster and Woodroffe 1993).

3 The tessellation method generates erroneous territory borders where a single social group occupies more than one main sett (Doncaster and Woodroffe 1993). The problems that this causes may be minimised by assuming that setts which are close together (less than about 200m) belong to the same social group. Tessellations generated around such setts may then be aggregated to predict the extent of territories.

4 Badgers caught at main, subsidiary and outlier setts falling within the territory borders predicted by the tessellation method can be assumed to belong to the social group occupying that territory. Outlier setts are sometimes located on territory borders. Where badger control aims to remove all members of a particular social group, it may be necessary to trap at these border outliers, even though this involves a risk of capturing members of neighbouring groups. In practice this risk will be small, since the proportion of badgers captured at outlier setts is small.

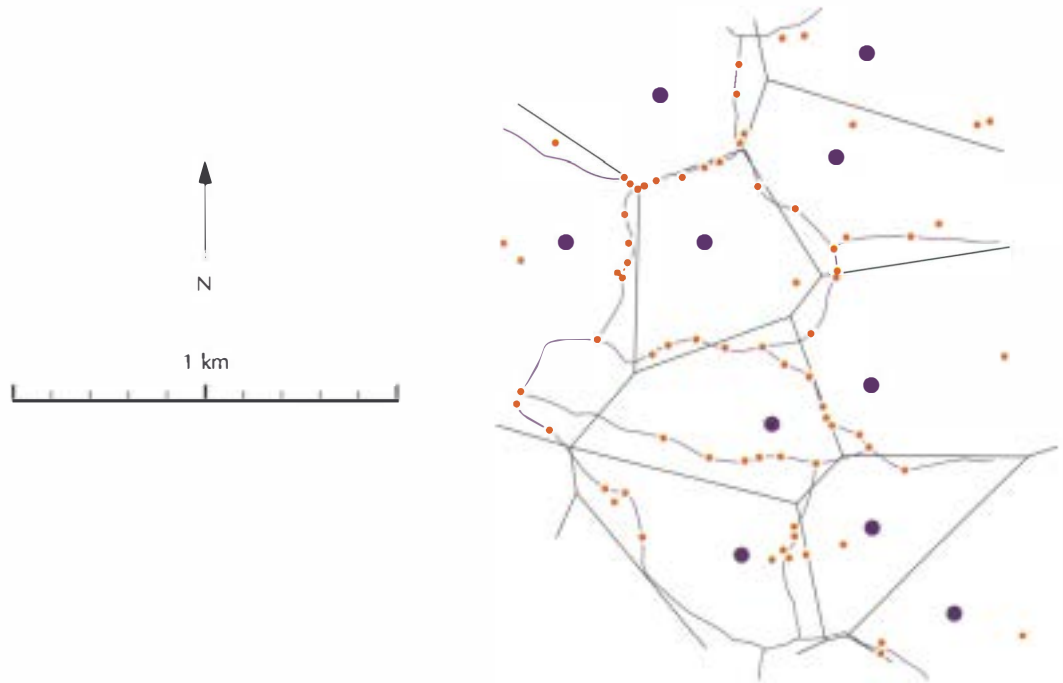

Figure 1

Comparison of known territory borders defined by bait-marking (curved lines) and territory borders predicted by the tessellation method (straight lines) for part of Woodchester Park. Large blue dots ● indicate sett locations, and red dots ● show the positions of latrines. Modified from Doncaster and Woodroffe (1993).

Analysis of the live test trial

1 We identify three aspects of the present implementation of the live test (as described in Appendix 3) that may hinder its success.

- (i) The sensitivity of the live test is low, hence many infected badgers may be missed.
- (ii) Only a small number of badgers were trapped to assess the infection status of animals using each sett, hence many setts used by infected animals may have been incorrectly identified.
- (iii) The removal of badgers on the basis of the setts where they were trapped, rather than the social groups to which they belonged, risked partial removal of social groups. This means that some infected animals may have been missed, and may also have increased transmission of TB between groups by social perturbation.

2 We analyse each of these factors and review the data on the effectiveness of the live test trial in reducing TB in badgers and cattle. We show that the live test trial is unlikely to have been effective as implemented. We show that modifying the protocol by increasing the number of badgers tested, and by removing badgers on the basis of social group membership rather than sett use, is unlikely to increase the potential cost-effectiveness of the live test unless the sensitivity of the test could be improved.

The sensitivity of the live test is low

3 The live test can detect only 41% of truly infected badgers on average (see Table 1), although some infected badgers are more easily detected than others. In addition, the live test may not discriminate between infected and immune animals (although immunity to TB, either innate or acquired, while strongly suspected, has yet to be demonstrated in badgers).

	% Sensitivity	% Specificity
Visible lesions	62.3	93.3
No visible lesions	36.5	94.3
Cubs	48.8	94.4
Adults	40.0	94.3
Males	47.6	93.5
Females	32.1	95.1
All badgers	40.7	94.3

Table 1 – The sensitivity (% of truly infected animals correctly identified) and specificity (% of truly uninfected animals correctly identified) of the live test for different categories of badgers.

Can the sensitivity of the test be improved?

4 The low sensitivity is the most significant hurdle to the effectiveness of the live test trial. In Chapter 6 we review the potential for an improved live test. More sensitive tests could be developed, but it is unlikely that they would allow rapid diagnosis. For a strategy based upon the identification and removal of infected badgers, diagnoses should ideally be available within a few hours of capture.

The number of badgers trapped to assess infection status was low

5 Low trapping efficiency coupled with poor test performance make it likely that many infected subgroups of badgers trapped at particular setts were incorrectly diagnosed as uninfected. As only one trapping week (i.e. four trapping nights) was used to determine the infection status of badgers using each sett, often only one or two badgers were caught at each sett (see Figure 1) and this pattern holds for all counties in the live test trial. This makes it unlikely that an infected badger would have been caught at any given sett, even if there was a high prevalence of infection among the badgers using that sett. If an infected badger was caught, there remained a high probability that it would not be detected by the live test (Table 2). Consequently, it was unlikely that infection would be detected at each sett, even in the extreme case where there were many infected badgers with lesions shedding *M. bovis*.

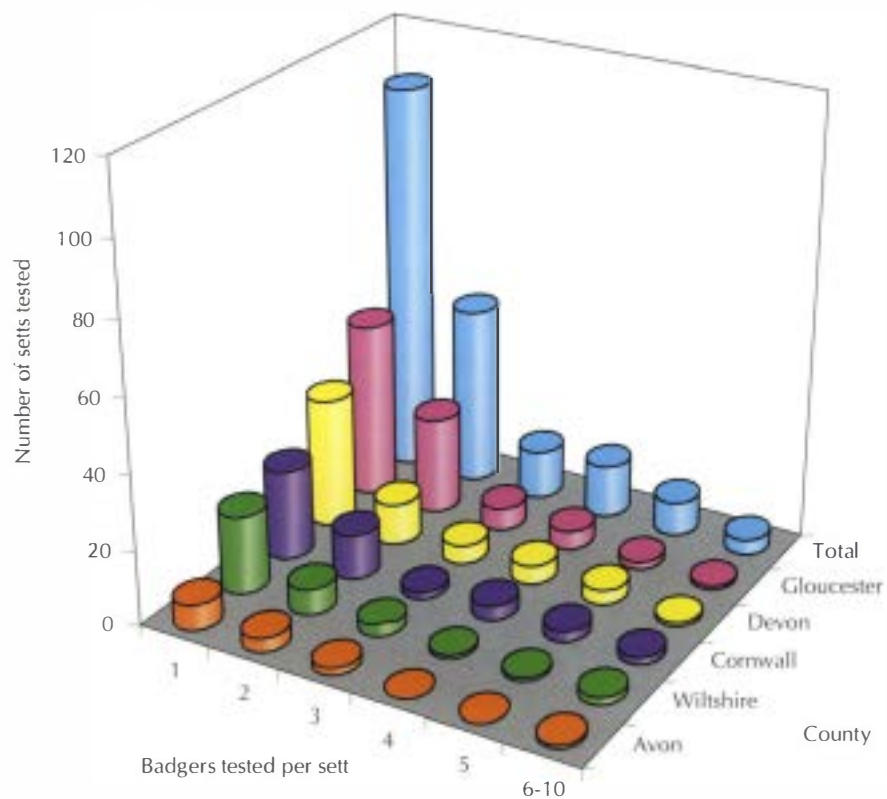

Figure 1 – The number of setts tested by county and by the number of badgers tested per sett.

Number of badgers caught	30% prevalence	50% prevalence
1	0.123	0.205
2	0.235	0.373
3	0.336	0.509
4	0.427	0.618
5	0.509	0.706
6	0.581	0.775
7	0.646	0.829
8	0.702	0.871
9	0.752	0.904
10	0.795	0.929

Table 2 – The probability of obtaining at least one positive ELISA test from sampling a subgroup of ten badgers given an infection prevalence of 30% or 50%.

6 Given the poor performance of the live test, even at the sett level, a surprisingly high proportion of setts (39 out of 196 or 19.9%) were identified as infected (Figure 2). Since so few badgers were trapped at each sett, this figure is likely to be conservative and suggests that prevalence among the badgers using each sett may have been extremely high.

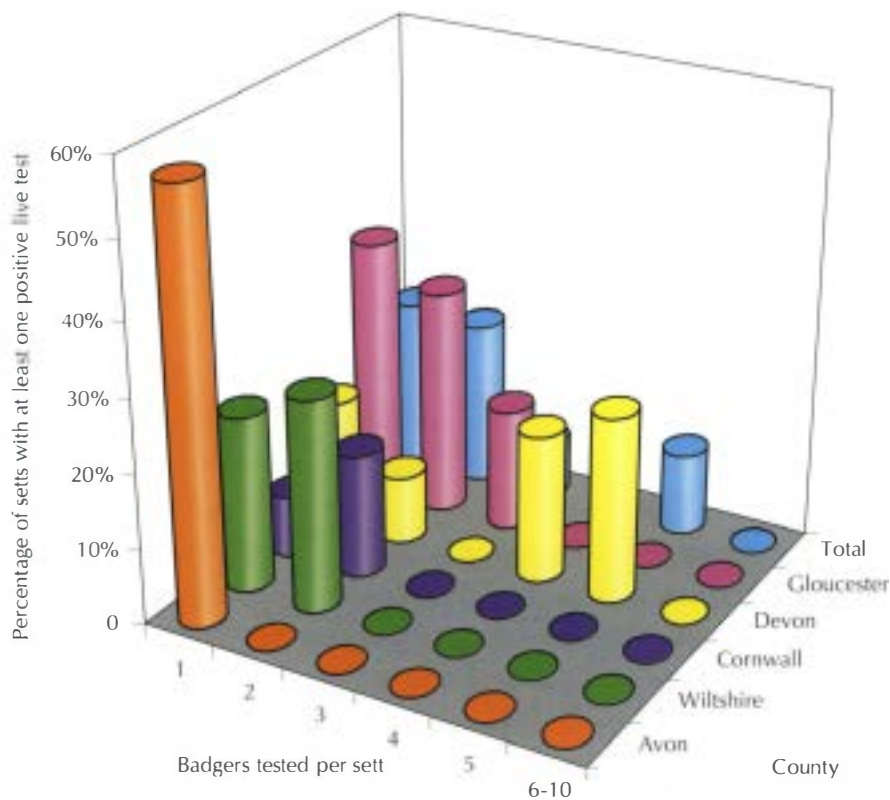

Figure 2 – The percentage of setts identified as infected (with at least one positive test) by county and by the number of badgers tested per sett.

7 The prevalence of infection in 'live test treatments' was not significantly different from that in 'no live test' (i.e. interim) operations (Table 5.2). This shows that the mere presence of badgers on the reactor land or breakdown farm was as good an indicator of infection as the identification of setts occupied by infected badgers by use of the live test. The only advantage of the live test trial over the interim strategy may have been the larger area of badger removal.

Could increasing the number of badgers caught improve the performance of the live test protocol?

8 In order to test more badgers, more than one 'live test week' would be needed. Increasing the testing period to two live test weeks would result in only moderate increases in the probability of correctly identifying setts used by infected badgers. Increasing the number of badgers caught from two to four badgers would result in an increase in sensitivity from 24% to 43% (assuming 33% prevalence) or from 37% to 62% (assuming 50% prevalence).

9 Increasing the number of live test weeks would involve a considerable increase in staff resources and an increased delay in launching the removal. The live test trial involved considerably more staff resources than the interim strategy (118 person days compared with 77 person days, see Appendix 16), of which a considerable amount was involved in the live test week.

10 Given the modest improvement of sensitivity and the greatly increased costs associated with trapping more badgers, we conclude that increasing the number of badgers caught would not constitute a cost-effective improvement to the live test protocol.

The unit of sampling and removal was the sett, not the social group

11 Most badger social groups occupy several setts of various sizes, but the live test trial made no distinction between the different types of sett. Since the unit of infection appears to be the social group, rather than the sett (Chapter 3), this approach meant that:

- (i) the infection status of badgers was assessed from smaller samples than could have been obtained if whole social groups had been considered; and
- (ii) only a proportion of badgers might have been removed from infected social groups.

Thus some infected animals may have been missed. Furthermore, partial removal of social groups might lead to social perturbation and spread of infection to other groups (see paragraphs 3.6.6 to 3.6.8). To address these points, we used the original survey maps to assign setts to social groups, and investigated whether a strategy that used the live test to identify infected social groups might firstly increase the probability of detecting infection and secondly improve the efficiency of removal.

12 Since extensive surveys were carried out for the live test trial, it was relatively easy to assign setts to social groups using Dirichlet tessellations (Appendix 14; Doncaster and Woodroffe 1993). There was a good correspondence between the boundaries of territories as predicted by the tessellation method and those suggested by the positions of latrines. Assignment of setts to social groups would have been easier still if main setts had been identified during the surveys.

Does grouping setts into social groups improve the probability of detecting infection?

13 Clustering the setts into social groups increased the number of badgers sampled from 1.9 (± 0.14 standard deviation) per sett to 3.4 (± 2.89 standard deviation) per social group. By increasing the number of animals sampled, grouping setts into social groups improved the probability of detecting infection. This effect might be reduced if the prevalence of infection were lower in the group than among the animals using a particular sett. However, given that infection tends to be aggregated within social groups, this effect is unlikely to be important. As noted above, doubling the number of badgers sampled from two to four results in an increase in sensitivity from 24-37% to 43-62% (for 30-50% prevalence).

Does grouping setts into social groups improve the efficiency of removal?

14 As suspected, using the live test at the level of the sett led to partial removal of social groups, which might generate social perturbation. Of 43 groups which contained one or more seropositive badgers (and should therefore have been removed completely), 25 (58%) were only partially removed (Figure 3).

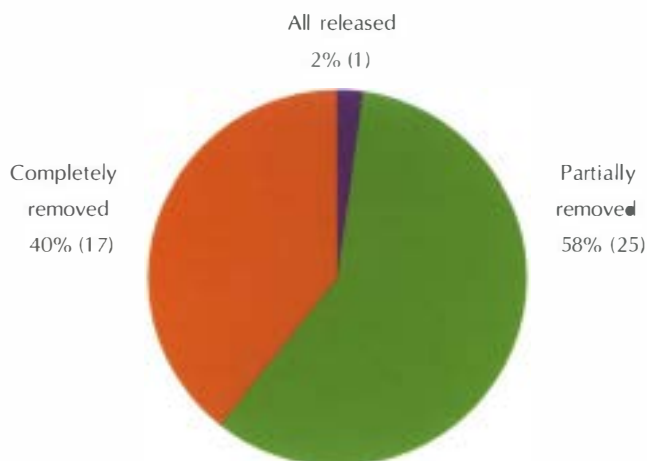

Figure 3 – The efficiency of removal of 43 social groups where at least one badger per group tested positive and hence all the groups should have been completely removed.

Could the combined use of more live test weeks and removal of social groups improve the sensitivity of the live test?

15 If setts were aggregated into social groups, and these social groups were trapped out, the probability of correctly identifying infected groups would still be low. Assuming that all badgers in a social group of six were sampled, the sensitivity would be between 58% and 78% (assuming two to three of these badgers were infected).

Conclusions

16 It is unlikely that the live test trial, as implemented, would be effective in reducing the prevalence of TB in badgers, and hence in reducing the risk of breakdowns to cattle. To improve the live test trial, while using the same diagnostic test, setts could be aggregated into social groups. This would avoid partial removal of social groups and would result in a modest increase in sensitivity. It would, however, involve more surveying and would result in the removal of many more uninfected badgers. Increasing the number of live test weeks to trap more badgers would result in a similarly modest increase in sensitivity, but at a cost of greatly increased staff resources. Even if setts were both aggregated into social groups and trapped for longer periods, the probability of detecting infection would still be unacceptably low. Given the limitations of the existing live test, modifications to the current live test protocol are unlikely to increase cost-effectiveness.

Staff resource requirements for the interim and live test badger removal operations

Activity	Interim strategy (person days)	Live test trial (person days)
1. Visiting the farmer	1	6
2. Surveying	4	30
3. Setting traps/prebaiting	10	20
4. Live test week	n/a	38
		[2 preparing, 16 collecting and returning badgers, 8 bleeding badgers, 4 anaesthetising and recording, 4 ELISA testing, 4 veterinary officer supervision]
5. Trapping out	60	20
6. Clearing up/ cleaning equipment	2	4
Total person days	77	118

ADJUVANT

substance which will boost the immune response when mixed with an antigen.

ANTIBODY

protein (immunoglobulin) formed by the immune system which reacts specifically with the foreign substance that induced its synthesis.

ANTIGEN

a foreign substance, often a protein, which is capable of stimulating an immune response (antibody or cell-mediated).

ATTENUATION

the process by which a pathogenic organism is rendered non-pathogenic (usually by prolonged culture *in vitro* or by genetic manipulation).

BACILLE CALMETTE GUERIN (BCG)

an attenuated strain of *M. bovis* used for human vaccination: the only vaccine that has produced a significant immunity against *M. tuberculosis* and at the same time has proved safe enough for human subjects.

BACTERIOPHAGES

bacteriophages are naturally occurring viruses that specifically infect bacteria.

BACTERIUM

a type of single-celled micro-organism with a solitary chromosome lacking nuclear membrane.

BAIT-MARKING

a means of establishing badger social group territories: coloured plastic chips are placed in palatable food at sett entrances using a different colour at each main sett; particular colours of chips found in faeces at different latrines, usually situated at territory boundaries, are then recorded.

BASIC REPRODUCTIVE RATE

the average number of secondary cases generated by a single primary case in a susceptible population.

BIOMARKER

a distinctive biological feature or characteristic aiding recognition.

BIOMASS

the sum total of living organisms in an ecosystem.

BREAKDOWN

MAFF define a breakdown as occurring when one or more reactors are revealed by the tuberculin skin test or when disease is suspected in either live cattle showing clinical disease or in carcasses with lesions at post-mortem examination.

BROCK TEST

an (indirect) ELISA test to detect the presence of antibodies to *M. bovis* in blood samples collected from live (trapped) badgers. Also known as the live test.

CARRIER

an individual who is infected but has no clinical symptoms (or signs) of disease.

CONFIRMED BREAKDOWN

a herd breakdown where the disease has been confirmed in one or more animals, usually reactors, by detection of lesions at post-mortem and/or through culture of *M. bovis*.

CYTOKINES

intercellular regulatory proteins produced by cells of the immune system that are induced by specific stimuli and that enhance or inhibit other cells of the immune system.

DAFF

Department of Agriculture, Food and Forestry, Republic of Ireland.

DANI

Department of Agriculture for Northern Ireland.

DENDROGRAM

a branching diagram after the style of a family tree reflecting the degree to which individual organisms or molecules are related to one another.

DNA TYPING

the use of DNA fingerprinting methods to distinguish between organisms of the same species.

ELISA TEST

a test used to detect antibodies or antigens, by measuring their binding to antigens or antibodies absorbed on plastic wells, by visualising colour changes caused by enzymes reacting in the test solution.

EPIDEMIOLOGY

the study of the distribution and dynamics of disease in populations. Its purpose is to identify factors which determine the occurrence of disease, and to provide a basis for intervention programmes. Epidemiological methods are also used to assess the variance, severity and magnitude of disease and related risks.

FAO

Food and Agriculture Organisation of the United Nations.

GENOME

the sum total of genes in the chromosome(s) of an organism.

GLYCOSYLATED LIPOPROTEIN

a protein which contains carbohydrate and lipid components.

GRANULOMA

a focal accumulation of inflammatory cells and fibrous tissue produced in any of various disease states, usually in response to infection or the presence of a foreign substance.

GRANULOMATOUS

pertaining to or of the nature of a granuloma.

HAEMATogenous SPREAD

spread by the blood.

INCIDENCE

the rate at which new cases of infection arise in a population.

LESION

a pathological change in organs or tissues produced by TB or other causes of disease.

LEUKOCYTE

white blood cell (includes lymphocytes and macrophages).

M. MICROTI

a mycobacterium that causes natural TB in voles. It is similar immunologically to *M. bovis* and was used in early TB vaccine trials.

M. VACCAE

a non-pathogenic environmental mycobacterium which was originally isolated from cow's milk or pasture.

MACROPHAGE

a cell found in many tissues in the body which is derived from the blood monocyte and which has an important role in host defence mechanisms. It engulfs and kills many bacteria but can also be the site of replication for *M. bovis*.

MAFF

Ministry of Agriculture, Fisheries and Food (UK).

MYCOBACTERIUM

a family of related bacteria characterised by a lipid-rich waxy coat that results in acid fast staining, which include species that cause TB.

NVL

no visible lesions on post-mortem examination.

OIE

Office International des Epizooties, Paris.

PATHOGENESIS

the process of disease development.

PCR

polymerase chain reaction (a modern DNA amplification technique).

POWER (statistical)

the probability of detecting an effect of a given size with a stated level of significance.

PREVALENCE

the proportion of the population infected at a particular time.

REA

restriction endonuclease analysis (a molecular typing technique).

REACTOR

animal which gives a positive result (i.e. 'reacts') to the tuberculin skin test.

REAGENT

a substance or solution used to produce a characteristic reaction in a chemical process.

RECOMBINANT MOLECULE

a molecule which is produced in a foreign organism by means of genetic engineering.

RFLP

restriction fragment length polymorphism (a molecular typing technique).

SENSITIVITY (of diagnostic test)

proportion of infected animals correctly identified.

SEROLOGICAL

pertaining to the effects seen in the blood or serum (e.g. serological test is usually a test performed on a blood sample taken from the animal).

SETT

burrow system which badgers use for shelter and breeding.

SHORT-TERM CULTURE FILTRATE

the filtrate obtained from a bacterial culture which is in the early stages of growth.

SOCIAL GROUP

group of badgers (averaging six to eight in a group, although a maximum of 25 has been recorded) occupying one or more setts within a well-defined territory from which badgers of other social groups would be excluded.

SPECIFICITY (of diagnostic test)

proportion of uninfected animals correctly identified.

SPOLIGOTYPE

a particular strain identified through a molecular typing technique called spoligotyping.

SPOLIGOTYPING

spacer-oligonucleotide typing (a molecular typing technique).

STRAIN

isolate of a bacterial species which is differentiated from other isolates of the same species by particular characteristics.

SUBUNIT VACCINE

a vaccine comprising part of an infective organism that is capable of conferring protective immunity.

T LYMPHOCYTES (also known as T cells)

cells which mediate cellular immune responses.

TRANSPOSON

a bacterial DNA sequence able to insert itself (often at random) at a new location in the bacterial genome.

TRANSPOSON MUTAGENESIS

the production of mutations using a transposon.

TUBERCLE BACILLUS

the bacterium which produces infection leading to TB (usually refers to *M. tuberculosis*, *M. bovis* or *M. microti*).

TUBERCULIN

a sterile, protein extract derived from the tubercle bacterium and used to diagnose TB in cattle by skin testing (also known as Purified Protein Derivative or PPD).

TYPE I PARISH

MAFF designation of a parish where there have been one or more confirmed herd breakdowns in the past six years attributed to infection by badgers. Badger removal operations may be undertaken at the discretion of State Veterinary Service staff, usually the Assistant Director for the region.

TYPE II PARISH

MAFF designation of a parish where there have been no confirmed herd breakdowns in the past six years attributed to infection by badgers. Badger removal operations may be undertaken only with the approval of the mini-Panel (a sub-committee of the MAFF Consultative Panel on Badgers and Bovine TB).

UNCONFIRMED BREAKDOWN

a herd breakdown which occurs when all reactors have no visible lesions and are culture negative for *M. bovis*.

VACCINE VECTOR

an attenuated organism into which genes from other pathogenic organisms can be introduced for the purpose of vaccination.

VL

visible lesions.

WHO

World Health Organisation.

ZOONOSIS

disease communicable between animals and man.

References

- Andersen, P., 1994. – Effective vaccination of mice against *Mycobacterium tuberculosis* infection with a soluble mixture of secreted mycobacterial proteins. *Infection and Immunity*, 62: 2536-2544.
- Anderson, R.M. and Trewheella, W., 1985. – Population dynamics of the badger (*Meles meles*) and the epidemiology of bovine tuberculosis (*Mycobacterium bovis*). *Philosophical Transactions of the Royal Society of London, B*, 310: 327-381.
- Aranaz, A., Liebana, E., Mateos, A., Dominguez, L., Vidal, D., Domingo, M., Gonzolez, O., Rodriguez-Ferri, E.F., Bunschoten, A.E., van Embden, J.D.A. and Cousins, D., 1996. – Spacer oligonucleotide typing of *Mycobacterium bovis* strains from cattle and other animals: a tool for studying epidemiology of tuberculosis. *Journal of Clinical Microbiology*, 34: 2734-2740.
- Benham, P.F.J. and Broom, D.M., 1991. – Responses of dairy cows to badger urine and faeces on pasture with reference to bovine tuberculosis transmission. *British Veterinary Journal*, 147: 517-531.
- Bentil, D.E. and Murray, J.D., 1993. – Modelling bovine tuberculosis in badgers. *Journal of Animal Ecology*, 62: 327-381.
- Besnard, M., Sauvion, S., Offredo, C., Gaudelus, J., Gaillard, J.L., Veber, F. and Blanche, S., 1993. – Bacillus Calmette-Guerin infection after vaccination of human immunodeficiency virus-infected children. *Pediatric Infectious Disease Journal*, 12: 993-997.
- Bouvier, G., Burgisser, H. and Scheider, P.A., 1957. – Observations sur les maladies du gibier, des oiseaux et des poissons faites en 1955 et 1956. *Schweizer Archiv für Tierheilkunde*, 99: 461-477.
- Bretcher, P.A., 1992. – A strategy to improve the efficiency of vaccination against tuberculosis and leprosy. *Immunology Today*, 13: 342-345.
- Brochier, B., Cost, F. and Pastoret, P.P., 1995. – Elimination of fox rabies from Belgium using a recombinant vaccinia-rabies vaccine: an update. *Veterinary Microbiology*, 46: 269-279.
- Buddle, B.M., Aldwell, F.E., Pfeffer, A., de Lisle, G.W. and Corner, L.A., 1994. – Experimental *Mycobacterium bovis* infection of cattle: effect of dose of *M. bovis* and pregnancy on immune responses and distribution of lesions. *New Zealand Veterinary Journal*, 42: 167-172.
- Buddle, B.M., Aldwell, F.E. and Wedlock, N., 1995a. – Vaccination of cattle and possums against bovine tuberculosis (Griffin, F. and de Lisle, G. (eds.)). In: *Tuberculosis in wildlife and domestic animals*. 28 August-1 September. Dunedin, New Zealand: 111-115.
- Buddle, B.M., de Lisle, G.W., Pfeffer, A. and Aldwell, F.E., 1995b. – Immunological responses and protection against *Mycobacterium bovis* in calves vaccinated with a low dose of BCG. *Vaccine*, 13: 1123-1130.
- Buddle, B.M., Keen, D., Thomson, A., Jowett, G., McCarthy, A.R., Heslop, J., de Lisle, G.W., Stanford, J.L. and Aldwell, F.E., 1995c. – Protection of cattle from bovine tuberculosis by vaccination with BCG by the respiratory or subcutaneous route, but not by vaccination with killed *Mycobacterium vaccae*. *Research in Veterinary Science*, 59: 10-16.
- Caffrey, J.P., 1994. – Status of bovine tuberculosis eradication programmes in Europe. *Veterinary Microbiology*, 40: 1-4.
- Canivenc, R. and Bonnin, M., 1981. – Environmental control of delayed implantation in the European badger (*Meles meles*). *Journal of Reproduction and Fertility Supplement*, 29: 25-33.
- Cheeseman, C.L., Cresswell, W.J., Harris, S. and Mallinson, P.J., 1988a. – Comparison of dispersal and other movements in two badger (*Meles meles*) populations. *Mammal Review*, 18: 51-59.
- Cheeseman, C.L., Jones, G.W., Gallagher, J. and Mallinson, P.J., 1981. – The population structure, density and prevalence of tuberculosis (*Mycobacterium bovis*) in badgers (*Meles meles*) from four areas in south-west England. *Journal of Applied Ecology*, 18: 795-804.
- Cheeseman, C.L., Little, T.W.A., Mallinson, P.J., Page, R.J.C., Wilesmith, J.W. and Pritchard, D.G., 1985. – Population ecology and prevalence of tuberculosis in badgers in an area of Staffordshire. *Mammal Review*, 15: 125-135.
- Cheeseman, C.L. and Mallinson, P.J., 1981. – Behaviour of badgers (*Meles meles*) infected with bovine tuberculosis. *Journal of Zoology*, 194: 284-289.
- Cheeseman, C.L., Mallinson, P.J., Ryan, J. and Wilesmith, J.W., 1993. – Recolonisation by badgers in Gloucestershire (Hayden, T.J. (ed.)). In: *The Badger*, Dublin: Royal Irish Academy: 73-93.
- Cheeseman, C.L., Wilesmith, J.W., Ryan, J. and Mallinson, P.J., 1987. – Badger population dynamics in a high-density area. *Symposia of the Zoological Society of London*, 58: 279-294.
- Cheeseman, C.L., Wilesmith, J.W. and Stuart, F.A., 1989. – Tuberculosis: the disease and its epidemiology in the badger, a review. *Epidemiology and Infection*, 103: 113-125.
- Cheeseman, C.L., Wilesmith, J.W., Stuart, F.A. and Mallinson, P.J., 1988b. – Dynamics of tuberculosis in a naturally infected badger population. *Mammal Review*, 18: 61-72.
- Clifton-Hadley, R.S., 1993. – The use of a geographical information system (GIS) in the control and epidemiology of bovine tuberculosis in south-west England (Thrusfield, M.V. (ed.)). In: *Proceedings of the Society of Veterinary Epidemiology and Preventative Medicine. Meeting at University of Exeter*, 31 March to 2 April 1993: 166-179.
- Clifton-Hadley, R.S., Sayers, A.R. and Stock, M.P., 1995a. – Evaluation of an ELISA for *Mycobacterium bovis* infection in badgers (*Meles meles*). *Veterinary Record*, 137: 555-558.
- Clifton-Hadley, R.S. and Wilesmith, J.W., 1991. – Tuberculosis in deer: a review. *Veterinary Record*, 129: 5-12.
- Clifton-Hadley, R.S., Wilesmith, J.W., Richards, M.S., Upton, P. and Johnston, S., 1995b. – The occurrence of *Mycobacterium bovis* infection in and around an area subject to extensive badger (*Meles meles*) control. *Epidemiology and Infection*, 114: 179-193.

- Clifton-Hadley, R.S., Wilesmith, J.W. and Stuart, F.A., 1993. – *Mycobacterium bovis* in the European badger (*Meles meles*): epidemiological findings in tuberculous badgers from a naturally infected population. *Epidemiology and Infection*, 111: 9-19.
- Cole, S.T., 1996. – Why sequence the genome of *Mycobacterium tuberculosis*? *Tubercle and Lung Disease*, 77: 486-490.
- Collins, D.M., de Lisle, G.W. and Gabric, D.M., 1986. – Geographic distribution of restriction types of *Mycobacterium bovis* isolates from brush-tailed possums (*Trichosurus vulpecula*) in New Zealand. *Journal of Hygiene*, 96: 431-438.
- Collins, D.M., Erasmuson, S.K., Stephens, D.M., Yates, G.F. and de Lisle, G.W., 1993. – DNA fingerprinting of *Mycobacterium bovis* strains by restriction fragment analysis and hybridization with insertion elements IS1081 and IS6110. *Journal of Clinical Microbiology*, 31: 1143-1147.
- Collins, D.M., Gabric, D.M. and de Lisle, G.W., 1988. – Typing of *Mycobacterium bovis* isolates from cattle and other animals in the same locality. *New Zealand Veterinary Journal*, 36: 45-46.
- Cresswell, W.J. and Harris, S., 1988. – Foraging behaviour and home-range utilization in a suburban badger (*Meles meles*) population. *Mammal Review*, 18: 37-49.
- Cresswell, W.J., Harris, S., Cheeseman, C.I. and Mallinson, P.J., 1992. – To breed or not to breed: an analysis of the social and density-dependent constraints on the fecundity of female badgers (*Meles meles*). *Philosophical Transactions of the Royal Society of London, B*, 338: 393-407.
- Cresswell, P., Harris, S. and Jefferies, D.J., 1990. – The history, distribution, status and habitat requirements of the badger in Britain. Peterborough: Nature Conservancy Council. 84pp.
- da Silva, J., Macdonald, D.W. and Evans, P.G.H., 1994. – Net costs of group living in a solitary forager, the Eurasian badger (*Meles meles*). *Behavioural Ecology*, 5: 151-158.
- da Silva, J., Woodroffe, R. and Macdonald, D.W., 1993. – Habitat, food availability and group territoriality in the European badger (*Meles meles*). *Oecologia*, 95: 558-564.
- de Lisle, G.W., Yates, G.F., Collins, D.M., Mackenzie, R.W., Crews, K.B. and Walker, R., 1995. – A study of bovine tuberculosis in domestic animals and wildlife in the MacKenzie Basin and surrounding areas using DNA fingerprinting. *New Zealand Veterinary Journal*, 43: 266-271.
- Dolan, L.A. and Lynch, K., 1992. – Badgers and bovine tuberculosis. *Irish Veterinary Journal*, 45: 133-135.
- Doncaster, C.P. and Woodroffe, R., 1993. – Den site can determine shape and size of badger territories: implications for group living. *Oikos*, 66: 88-93.
- Dowling, L.A. and Schleeauf, S.M., 1991. – Specific antibody responses to *Mycobacterium bovis* in infected cattle analysed with six mycobacterial antigens in enzyme-linked immunosorbent assays. *Research in Veterinary Science*, 50: 157-161.
- Dunnet, G.M., Jones, D.M. and McInerney, J.P., 1986. – Badgers and bovine tuberculosis. HMSO. 73pp.
- Economic Advisory Council. Committee on Cattle Diseases, report. May 1934, Cmd 4591, HMSO.
- Evans, P.G.H., Macdonald, D.W. and Cheeseman, C.L., 1989. – Social structure of the Eurasian badger (*Meles meles*): genetic evidence. *Journal of Zoology*, 218: 587-595.
- Fanning, A. and Edwards, S., 1991. – *Mycobacterium bovis* infection in human beings in contact with elk (*Cervus elaphus*) in Alberta, Canada. *Lancet*, 338: 1253-1255.
- Fifis, T., Corner, L.A., Rothel, J.S. and Wood, P.R., 1994a. – Cellular and humoral immune responses of cattle to purified *Mycobacterium bovis* antigens. *Scandinavian Journal of Immunology*, 39: 267-274.
- Fifis, T., Costopoulos, C., Corner, L.A. and Wood, P.R., 1992. – Serological reactivity to *Mycobacterium bovis* protein antigens in cattle. *Veterinary Microbiology*, 30: 343-354.
- Fifis, T., Rothel, J.S. and Wood, P.R., 1994b. – Soluble *Mycobacterium bovis* protein antigens: studies on their purification and immunological evaluation. *Veterinary Microbiology*, 40: 65-81.
- Fine, P.E. and Rodrigues, L.C., 1990. – Modern vaccines. Mycobacterial diseases. *Lancet*, 335: 1016-1020.
- Francis, J., 1947. – Bovine tuberculosis including a contrast with human tuberculosis. London: Staples Press, 220pp.
- Francis, J., 1958. – Tuberculosis in animals and man: a study in comparative pathology. London: Cassel. 357pp.
- Gallagher, J., Monies, R., Gavier-Widen, M.D. and Rule, B. (unpublished data). – The role of the non diseased animal in the pathogenesis of tuberculosis in the badger.
- Georghiou, P., Patel, A.M., Konstantinos, A., Streeton, J.A. and Robinson, P., 1989. – *Mycobacterium bovis* as an occupational hazard in abattoir workers. *Australian and New Zealand Journal of Medicine* (correspondence), 19: 4409-4410.
- Goodger, J., Nolan, A., Russell, W.P., Dalley, D.J., Thorns, C.J., Stuart, F.A., Croston, P. and Newell, D.G., 1994a. – Serodiagnosis of *Mycobacterium bovis* infection in badgers: development of an indirect ELISA using a 25 kDa antigen. *Veterinary Record*, 135: 82-85.
- Goodger, J., Russell, W.P., Nolan, A. and Newell, D.G., 1994b. – Production and characterisation of a monoclonal badger anti-immunoglobulin G and its use in defining the specificity of *Mycobacterium bovis* infections in badgers by western blot. *Veterinary Immunology and Immunopathology*, 40: 243-252.
- Griffin, J.F.T., Nagai, S. and Buchan, G.S., 1991. – Tuberculosis in domesticated red deer: comparison of purified protein derivative and the specific protein MPB70 for *in vitro* diagnosis. *Research in Veterinary Science*, 50: 279-285.
- Griffin, J.M. and Dolan, L.A., 1995. – The role of cattle-to-cattle transmission of *Mycobacterium bovis* in the epidemiology of tuberculosis in cattle in the Republic of Ireland – A review. *Irish Veterinary Journal*, 48: 228-234.

- Griffin, J.M., 1993. – The role of bought-in cattle in herd breakdowns due to tuberculosis in part of county Cavan during 1989. *Irish Veterinary Journal*, 46: 143-148.
- Griffiths, H.I. and Thomas, D.H., 1993. – The status of the badger *Meles meles* (L. 1758) (Carnivora, Mustelidae) in Europe. *Mammal Review*, 23: 17-58.
- Guleria, I., McAdam, R.A., Kalpana, G., Jacobs, W.R. and Bloom, B.R., 1996. – Auxotrophic vaccines for tuberculosis. *Nature Medicine*, 2: 334-337.
- Harboe, M., Nagai, S., Wiker, H.G., Sletten, K. and Haga, S., 1995. – Homology between the MPB70 and MPB83 proteins of *Mycobacterium bovis* BCG. *Scandinavian Journal of Immunology*, 42: 46-51.
- Harboe, M., Oettinger, T., Wiker, H.G., Rosenkrands, I. and Anderson, P., 1996. – Evidence for occurrence of the ESAT-6 protein in *Mycobacterium tuberculosis* and virulent *Mycobacterium bovis* and its absence in *Mycobacterium bovis* BCG. *Infection and Immunity*, 64: 16-22.
- Hardie, R.M. and Watson, J.M., 1992. – *Mycobacterium bovis* in England and Wales: past, present and future. *Epidemiology and Infection*, 109: 23-33.
- Harris, S. and Cresswell, W.J., 1987. – Dynamics of a suburban badger (*Meles meles*) population. *Symposia of the Zoological Society of London*, 58: 295-311.
- Hewinson, R.G., Michell, S.L., Russell, W.P., McAdam, R.A. and Jacobs Jr, W.R., 1996. – Molecular characterisation of MPT83: a seroactive antigen of *Mycobacterium tuberculosis* with homology to MPT70. *Scandinavian Journal of Immunology*, 43: 490-499.
- Hewinson, R.G., Russell, W.P., Pollock, J.M. and Jacobs Jr, W.R., 1995. – The use of shuttle cosmid libraries to detect novel antigens of *Mycobacterium bovis* (Griffin, F. and de Lisle, G.W. (eds.)). In: *Tuberculosis in wildlife and domestic animals, Otago Conference Series 3*. University of Otago Press, Dunedin, New Zealand: 40-43.
- Hughes, M.S., Neill, S.D. and Rodgers, M.S., 1996. – Vaccination of the badger (*Meles meles*) against *Mycobacterium bovis*. *Veterinary Microbiology*, 51: 363-379.
- Hutchings, M.R. and Harris, S., 1997. – Effects of farm management practices on cattle grazing behaviour and the potential for transmission of bovine tuberculosis from badgers to cattle. *Veterinary Journal*, 153: 149-162.
- Huygen, K., Content, J., Denis, O., Montgomery, D. L., Yawman, A. M., Deck, R. R., De Witt, C. M., Orme, I. M., Baldwin, S., D'Souza, C., Drowart, A., Lozes, E., Vandenbussche, P., Van Vooren, J-P., Liu, M.A. and Ulmer, J.B., 1996. – Immunogenicity and protective efficacy of a tuberculosis DNA vaccine. *Nature Medicine*, 2: 893-898.
- Jubb, K.V.F., Kennedy, P.C. and Palmer, N., 1993. – Pathology of domestic animals, 4th edition, vol. 2. New York and London: Academic Press: 641-652.
- King, E.J., Lovell, D.J. and Harris, S., 1997. – What factors influence TB levels in cattle herds? In: *Proceedings of the 1st European Vertebrate management conference. Meeting at the University of York*, 1 to 3 September, 1997. Paper 39.
- Kruuk, H., 1978a. – Foraging and spatial organisation in the European badger (*Meles meles*). *Behavioural Ecology and Sociobiology*, 4: 75-89.
- Kruuk, H., 1978b. – Spatial organisation and territorial behaviour of the European badger (*Meles meles*). *Journal of Zoology*, 184: 1-19.
- Kruuk, H., 1989. – The social badger. Oxford: Oxford University Press. 155pp.
- Kruuk, H. and Parish, T., 1982. – Factors affecting population density, group size and territory size of the European badger (*Meles meles*). *Journal of Zoology*, 196: 31-39.
- Kruuk, H. and Parish, T., 1987. – Changes in the size of groups and ranges of the European badger (*Meles meles*) in an area in Scotland. *Journal of Animal Ecology*, 56: 351-364.
- Kruuk, H., Parish, T., Brown, C.A.J. and Carera, J., 1979. – The use of pasture by the European badger (*Meles meles*). *Journal of Applied Ecology*, 16: 453-459.
- Lenzini, L., Rottoli, P. and Rottoli, L., 1977. – The spectrum of human tuberculosis. *Clinical Immunology*, 27: 230-237.
- Leslie, I.W. and Herbert, C.N., 1975. – Comparison of the specificity of human and bovine tuberculin PPD for testing cattle. *Veterinary Record*, 96: 332-341.
- Levine, M.M., Woodrow, G.C., Kaper, J.B. and Cobon, G.S., 1997. – New generation vaccines. New York: Marcel Dekker Inc. 1240pp.
- Little, T.W.A., Naylor, P.F. and Wilesmith, J.W., 1982. – Laboratory study of *Mycobacterium bovis* infection in badgers and calves. *Veterinary Record*, 111: 550-557.
- Macdonald, D., Tuytens, F., Swinton, J., Hitchcock, C., Nokes, J., Short, R. and Clark, J., 1996. – Feasibility study on the fertility control of badgers (*Meles meles*). Technical report to the Ministry of Agriculture, Fisheries and Food. The Wildlife Conservation Research Unit, Department of Zoology, University of Oxford. 121pp.
- MAFF, 1979. – 3rd report on Bovine Tuberculosis in Badgers.
- MAFF, 1987. – 11th report on Bovine Tuberculosis in Badgers.
- MAFF, 1996. Chief Veterinary Officer's report.
- MAFF, Intervention Board, 1997. – Government expenditure plans 1997-98 to 1999-2000. 1997 Departmental Report by the Ministry of Agriculture, Fisheries and Food and the Intervention Board. Stationary Office, London, Cm 3604. 246pp.
- Mahairas, G.G., Sabo, P.J., Hickey, M.J., Singh, D.C. and Stover, C.K., 1996. – Molecular analysis of genetic differences between *Mycobacterium bovis* BCG and virulent *Mycobacterium bovis*. *Journal of Bacteriology*, 178: 1274-1282.
- Malin, A.S. and Young, D.B., 1996. – Designing a vaccine for tuberculosis. *British Medical Journal*, 312: 1495.

- Matsuo, T., Matsuo, H., Ohara, N., Matsumoto, S., Kitaura, H., Mizuno, A. and Yamada, T., 1996. – Cloning and sequencing of an MPB70 homologue corresponding to MPB83 from *Mycobacterium bovis* BCG. *Scandinavian Journal of Immunology*, 43: 483-489.
- May, R.M., 1973. – Stability and complexity in model ecosystems. Princeton: Princeton University Press. 235pp.
- McCarthy, J., 1993. – The badger vaccination trial in West Cork: Progress report (Hayden, T.J.,(ed.)). In: *The Badger*, Dublin: Royal Irish Academy: 181-188.
- McIlroy, S.G., Neill, S.D. and McCracken, R.M., 1986. – Pulmonary lesions and *Mycobacterium bovis* excretion from the respiratory tract of tuberculin reacting cattle. *Veterinary Record*, 118: 718-721.
- Monaghan, M.L., Doherty, M.L., Collins, J.D., Kazda, J.F. and Quinn, P.J., 1994. – The tuberculin test. *Veterinary Microbiology*, 40: 111-124.
- Morris, R.S., Pfeiffer, D.U. and Jackson, R., 1994. – The epidemiology of *Mycobacterium bovis* infections. *Veterinary Microbiology*, 40: 153-177.
- Neal, E. and Cheeseman, C.L., 1996. – *Badgers*. London: Poyser. 271pp.
- Neal, E.G. and Harrison, R.J., 1958. – Reproduction in the European badger (*Meles meles*). *Transactions of the Zoological Society of London*, 29: 67-131.
- Neill, S.D., Cassidy, J., Hanna, J., Mackie, D.P., Pollock, J.McA., Clements, A., Walton, E. and Bryson, D.G., 1994a. – Detection of *Mycobacterium bovis* infection in skin test-negative cattle with an assay for bovine interferon-gamma. *Veterinary Record*, 135: 134-135.
- Neill, S.D., Hanna, J., Mackie, D.P. and Bryson, T.G.D., 1992. – Isolation of *Mycobacterium bovis* from the respiratory tracts of skin test-negative cattle. *Veterinary Record*, 131: 45-47.
- Neill, S.D., Pollock, J.M., Bryson, D.B. and Hanna, J., 1994b. – Pathogenesis of *Mycobacterium bovis* infection in cattle. *Veterinary Microbiology*, 40: 41-52.
- Newell, D.G., Clifton-Hadley, R.S. and Cheeseman, C.L., 1997. – The kinetics of serum antibody responses to natural infections with *Mycobacterium bovis* in one badger social group. *Epidemiology and Infection*, 118: 173-180.
- New Zealand Veterinary Journal, 1995. Volume 43, (7).
- Nolan, A. and Wilesmith, J.W., 1994. – Tuberculosis in badgers (*Meles meles*). *Veterinary Microbiology*, 40: 179-191.
- O I E, 1996 – Animal health status and disease control methods in member countries in 1996.
- O'Reilly, L.M. and Daborn, C.J., 1995. – The epidemiology of *Mycobacterium bovis* infections in animals and man – a review. *Tubercle and Lung Disease*, 76: 1-46.
- Ortolani, A. and Caro, T.M., 1996. – The adaptive significance of color patterns in carnivores: Phylogenetic tests of classic hypotheses (Gittleman, J.L. (ed.)). In: *Carnivore Behavior, Ecology and Evolution, Volume 2*. New York: Cornell University Press, 132-188.
- Page, R.J.C., Ross, J. and Langton, S.D., 1994. – Seasonality of reproduction in the European badger (*Meles meles*) in south-west England. *Journal of Zoology*, 233: 69-91.
- Pal, P.G. and Horwitz, M.A., 1992. – Immunisation with extracellular proteins of *Mycobacterium tuberculosis* induces cell-mediated immune responses and substantial protective immunity in a guinea pig model of pulmonary tuberculosis. *Infection and Immunity*, 60: 4781-4792.
- Plackett, P., Ripper, J., Corner, L.A., Small, K., de Witte, K., Melville, L., Hides, S. and Wood, P.R., 1989. – An ELISA for the detection of anergic tuberculous cattle. *Australian Veterinary Journal*, 66: 15-19.
- Polis, G.A. and Holt, R.D., 1992. – Intraguild predation: The dynamics of complex trophic interaction. *Trends in Ecology and Evolution*, 7: 151-154.
- Pollock, J.M. and Anderson, P., 1997a. The potential of the ESAT-6 antigen secreted by virulent mycobacteria for specific diagnosis of tuberculosis. *Journal of Infectious Diseases*, 175: 1251-1254.
- Pollock, J.M. and Anderson, P., 1997b. – Predominant recognition of the ESAT-6 protein in the first phase of interferon with *Mycobacterium bovis* in cattle. *Infection and Immunity*, 65: 2587-2592.
- Pollock, J.M., Pollock, D.A., Campbell, D.G., Girvin, R.M., Crockard, A.D., Neill, S.D. and Mackie, D.P., 1996. – Dynamic changes in circulating and antigen-responsive T-cell sub-populations post-*Mycobacterium bovis* infection in cattle. *Immunology*, 87: 236-241.
- Pritchard, D.G., 1988. – A century of bovine tuberculosis 1888-1988, Conquest and Controversy. *Journal of Comparative Pathology*, 99: 357-399.
- Pritchard, D.G., Stuart, F.A., Brewer, J.I., Mahmood, K.H., 1987. – Experimental infection of badgers (*Meles meles*) with *Mycobacterium bovis*. *Epidemiology and Infection*, 98: 145-154.
- Radford, A.J., Wood, P.R., Billman-Jacobe, H., Geyson, H.M., Mason, T.J. and Tribbick, G., 1990. – Epitope mapping of the *Mycobacterium bovis* secretory protein MPB70 using overlapping peptide analysis. *Journal of General Microbiology*, 136: 265-272.
- Radunz, B.L. and Lepper, A.W.D., 1985. – Suppression of skin reactivity to bovine tuberculin in repeat tests. *Australian Veterinary Journal*, 62: 191-194.
- Ragg, J.R., Moller, H. and Waldrup, K.A., 1995a. – The distribution of gross lesions of tuberculosis caused by *Mycobacterium bovis* in feral ferrets (*Mustela furo*) from Otago, New Zealand. *New Zealand Veterinary Journal*, 43: 338-341.
- Ragg, J.R., Moller, H. and Waldrup, K.A., 1995b. – The prevalence of tuberculosis infection in feral populations of cats (*Felis catus*), ferrets (*Mustela furo*) and stoats (*Mustela erminea*) in Otago and Southland, New Zealand. *New Zealand Veterinary Journal*, 43: 333-337.
- Ritacco, V., Lopez, B., De Kantor, I.N., Barrera, L., Errico, F. and Nader, A., 1991. – Reciprocal cellular and humoral immune responses in bovine tuberculosis. *Research in Veterinary Science*, 50: 365-367.

- Robinson, P., Morris, D. and Antic, R., 1988. – *Mycobacterium bovis* as an occupational hazard in abattoir workers. *Australian and New Zealand Journal of Medicine* (article), 18: 701-703.
- Rogers, L.M., Cheeseman, C.L., Mallinson, P.J. and Clifton-Hadley, R. (in press). The demography of a high-density badger (*Meles meles*) population. *Journal of Zoology*.
- Roper, T.J., 1992. – Badger *Meles meles* setts – architecture, internal environment and function. *Mammal Review*, 22: 43-53.
- Roper, T.J., 1993. – Badger setts as a limiting resource (Hayden, T.J. (ed.)). In: *The Badger*, Dublin: Royal Irish Academy: 26-34.
- Roper, T.J. and Christian, S.F., 1992. – Sett use in badgers (*Meles meles*) (Priede, I.G. and Swift, S.H. (eds.)). Radio telemetry: remote monitoring and tracking of animals. Chichester, Ellis Harwood: 661-669.
- Roper, T.J., Conradt, L., Butler, J., Christian, S.F., Ostler, J. and Schmid, T.K., 1993. – Territorial marking with faeces in badgers (*Meles meles*): a comparison of boundary and hinterland latrine use. *Behaviour*, 127: 289-307.
- Roper, T.J. and Lüps, P., 1993. – Disruption of territorial behaviour in badgers (*Meles meles*). *Zeitschrift für Säugetierkunde*, 58: 252-255.
- Ruxton, G.D., 1996. – The effects of stochasticity and seasonality on model dynamics – bovine tuberculosis in badgers. *Journal of Animal Ecology*, 65: 495-500.
- Samper, S., Martin, C., Pinedo, A., Rivero, A., Blazquez, J., Baquero, F., van Soelingen, D. and van Embden, J., 1997. – Transmission between HIV-infected patients of multidrug-resistant tuberculosis caused by *Mycobacterium bovis*. *AIDS*, 11: 1237-1242.
- Skuce, R.A., Brittain, D., Hughes, M.S. and Neill, S.D., 1996. – Differentiation of *Mycobacterium bovis* isolates from animals by DNA typing. *Journal of Clinical Microbiology*, 34: 2469-2474.
- Sleeman, D.P., 1992. – Long distance movements in an Irish badger population (Priede, I.G. and Swift, S.H. (eds.)). In: *Wildlife telemetry. Proceedings of the 4th European Conference on Wildlife telemetry*. London. Ellis Harwood: 670- 676.
- Sleeman, D.P. and Mulcahy, M.F., 1993. – Behaviour of Irish badgers in relation to bovine tuberculosis (Hayden, T.J. (ed.)). In: *The Badger*, Dublin: Royal Irish Academy: 154-165.
- Smal, C., 1995. – The badger and habitat survey of Ireland. Dublin: National Parks and Wildlife Service and Department of Agriculture, Food and Forestry (DAFF, Republic of Ireland). 22 pp.
- Smith, G.S., Richards, M.S., Clifton-Hadley, R.S. and Cheeseman, C.L., 1995. – Modelling bovine tuberculosis in badgers in England – preliminary results. *Mammalia*, 59: 639-650.
- Stanford, J.L., Bahr, G.M., Rook, G.A., Shaaban, M.A., Chugh, T.D. and Gabriel, M., 1990. – Immunotherapy with *Mycobacterium vaccae* as an adjunct to chemotherapy in the treatment of pulmonary tuberculosis. *Tubercle*, 71: 87-93.
- Stuart, F.A., Mahmood, K.H., Stanford, J.L. and Pritchard, D.G., 1988. – Development of diagnostic tests for, and vaccination against, tuberculosis in badgers. *Mammal Review*, 18: 74-75.
- Swinton, J., Tuytens, F., Macdonald, D.W., Nokes, D.J., Cheeseman, C.L. and Clifton-Hadley, R., 1997. – Comparison of fertility control and lethal control of bovine tuberculosis in badgers: the impact of perturbation induced transmission. *Philosophical Transactions of the Royal Society of London, B*, 352: 619-631.
- Tang, D.C., de Vit, M. and Johnston, S.A., 1992. – Genetic immunisation is a simple method for eliciting an immune response. *Nature*, 356: 152-154.
- Tascon, R.E., Colston, M.J., Tagno, S., Stravropoulos, E., Gregory, D. and Lowrie, D.B., 1996. – Vaccination against tuberculosis by DNA injection. *Nature Medicine*, 2: 888-892.
- Thoen, C.O. and Steele, J.H. (eds.) 1995. – *Mycobacterium bovis* infection in animals and humans. Iowa State University Press.
- Thorns, C.J. and Morris, J.A., 1983. – The immune spectrum of *mycobacterium bovis* infections in some mammalian species: a review. *Veterinary Bulletin*, 53: 543-550.
- Tuytens, F.A.M. and Macdonald, D.W., (in press)a. Fertility control: an option for non-lethal control of wild carnivores? *Animal Welfare*.
- Tuytens, F.A.M. and Macdonald, D.W., (in press)b. Sterilisation as an alternative strategy to control wildlife diseases: bovine tuberculosis in European badgers as a case study. *Biodiversity and Conservation*.
- Tuytens, F.A.M. and Macdonald, D.W., 1995. – The consequences of perturbation caused by badger removal for the control of TB in cattle: a study of behaviour, population dynamics and epidemiology. First annual report: Wildlife Conservation Research Unit.
- Tuytens, F.A.M. and Macdonald, D.W., 1997. – The consequences of perturbation caused by badger removal for the control of TB in cattle: a study of behaviour, population dynamics and epidemiology. Second annual report: Wildlife Conservation Research Unit.
- van Embden, J.D., Cave, M.D., Crawford, J.T., Dale, J.W., Eisenach, K.D., Gicquel, B., Hermans, P., Martin, C., McAdam, R., Shinnick, T.M. and Small, P.M., 1993. – Strain identification of *Mycobacterium tuberculosis* by DNA fingerprinting: recommendations for a standardised methodology. *Journal of Clinical Microbiology*, 31: 406-409.
- Wandeler, A.I. and Graf, M., 1982. – Der geschlechtszyklus weiblicher Dachse (*Meles meles*) in der Schweiz. *Revue Suisse de Zoologie*, 89: 1009-1016.
- White, P.C.L. and Harris, S., 1995a. – Bovine tuberculosis in badger (*Meles meles*) populations in South West England – The use of a spatial stochastic simulation-model to understand the dynamics of the disease. *Philosophical Transactions of the Royal Society of London, B*, 349: 391-413.

- White, P.C.L. and Harris, S., 1995b. – Bovine tuberculosis in badger (*Meles meles*) populations in South West England – An assessment of past, present and possible future control strategies using simulation modelling. *Philosophical Transactions of the Royal Society of London, B*, 349: 415-432.
- White, P.C.L., Brown, J.A. and Harris, S., 1993. – Badgers (*Meles meles*), cattle and bovine tuberculosis: a hypothesis to explain the influence of habitat on the risk of disease transmission in south-west England. *Proceedings of the Royal Society of London, B*, 253: 277-284.
- WHO/FAO/OIE, Report, 1994. – Consultation on animal tuberculosis vaccines. *World Health Organisation, Veterinary Public Health Unit, Geneva*. WHO/CDS/MPH/94.138.
- Wiker, H.G., Nagai, S., Hewinson, R.G., Russell, W.P. and Harboe, M., 1996. – Heterogenous expression of the related MPB70 and MPB83 proteins distinguish various substrains of *Mycobacterium bovis* BCG and *Mycobacterium tuberculosis* H37Rv. *Scandinavian Journal of Immunology*, 43: 374-380.
- Wilesmith, J.W., Clifton-Hadley, R.S. and Ryan, J.B.M., 1993. – Tuberculosis in badgers and cattle: preliminary epidemiological analyses to assess the adoption of a selective, pre-emptive badger control strategy using a serological test on badgers. MAFF Internal Report, CPB/417. 76pp.
- Wilesmith, J.W., Little, T.W.A., Thompson, H.V. and Swan, C., 1982. – Bovine tuberculosis in domestic and wild animals in an area of Dorset. I. Tuberculosis in cattle. *Journal of Hygiene*, 89: 195-210.
- Wilesmith, J.W. and Williams, D.R., 1986. – Tuberculosis lesions in reactor cows. *Veterinary Record*, 119: 51.
- Wilesmith, J.W. and Williams, D.R., 1987. – Observations on the incidence of herds with non-visible lesioned tuberculin test reactors in south-west England. *Epidemiology and Infection*, 99: 173-178.
- Wilson, G., Harris, S. and McLaren, G., 1997. – Changes in the British badger population, 1988-1997. London: People's Trust For Endangered Species. 142pp.
- Wood, P.R., Corner, L.A. and Plackett, P., 1990. – Development of a simple, rapid *in vitro* cellular assay for bovine tuberculosis based on the production of gamma interferon. *Research in Veterinary Science*, 49: 46-49.
- Wood, P.R., Corner, L.A., Rothel, J.S., Baldock, C., Jones, S.L., Cousins, D.B., McCormick, B.S., Francis, B.R., Creeper, J. and Tweedle, N.E., 1991. – Field comparison of the interferon-gamma assay and the intradermal tuberculin test for the diagnosis of bovine tuberculosis. *Australian Veterinary Journal*, 68: 286-290.
- Wood, P.R. and Rothel, J.S., 1994. – *In vitro* immunodiagnostic assays for bovine tuberculosis. *Veterinary Microbiology*, 40: 125-135.
- Woodroffe, R., 1992. – Factors affecting reproductive success in the European badger (*Meles meles*). D.Phil. Thesis, University of Oxford.
- Woodroffe, R. and Macdonald, D.W., 1993. – Badger sociality – models of spatial grouping. *Symposia of the Zoological Society of London*, 65: 145-169.
- Woodroffe, R. and Macdonald, D.W., 1995a. – Costs of breeding status in the European badger (*Meles meles*). *Journal of Zoology*, 235: 237-245.
- Woodroffe, R. and Macdonald, D.W., 1995b. – Female/female competition in European badgers (*Meles meles*): effects on breeding success. *Journal of Animal Ecology*, 64: 12-20.
- Woodroffe, R., Macdonald, D.W. and da Silva, J., 1995. – Dispersal and philopatry in the European badger (*Meles meles*). *Journal of Zoology*, 237: 227-239.
- Zuckerman, Lord., 1980. – Badgers, Cattle and Tuberculosis, HMSO. 107pp.

Further copies of this report are available from:

MAFF Publications, Admail 6000, London SW1A 2XX. Tel: 0645 556000

Produced by The Ministry of Agriculture, Fisheries and Food

© Crown copyright 1997

PB 3423

£35