



THE UNIVERSITY *of* EDINBURGH

Edinburgh Research Explorer

Enhanced Utilisation of Voltage Control Resources with Distributed Generation

Citation for published version:

Keane, A, Ochoa, LF, Dent, CJ & Harrison, G 2011, 'Enhanced Utilisation of Voltage Control Resources with Distributed Generation', *IEEE Transactions on Power Systems*, vol. 26, no. 1, pp. 252-260. <https://doi.org/10.1109/TPWRS.2009.2037635>

Digital Object Identifier (DOI):

[10.1109/TPWRS.2009.2037635](https://doi.org/10.1109/TPWRS.2009.2037635)

Link:

[Link to publication record in Edinburgh Research Explorer](#)

Document Version:

Peer reviewed version

Published In:

IEEE Transactions on Power Systems

Publisher Rights Statement:

(c) 2011 IEEE. Personal use of this material is permitted. Permission from IEEE must be obtained for all other users, including reprinting/ republishing this material for advertising or promotional purposes, creating new collective works for resale or redistribution to servers or lists, or reuse of any copyrighted components of this work in other works."

General rights

Copyright for the publications made accessible via the Edinburgh Research Explorer is retained by the author(s) and / or other copyright owners and it is a condition of accessing these publications that users recognise and abide by the legal requirements associated with these rights.

Take down policy

The University of Edinburgh has made every reasonable effort to ensure that Edinburgh Research Explorer content complies with UK legislation. If you believe that the public display of this file breaches copyright please contact openaccess@ed.ac.uk providing details, and we will remove access to the work immediately and investigate your claim.



Enhanced Utilisation of Voltage Control Resources with Distributed Generation

Andrew Keane, *Member, IEEE*, Luis F. Ochoa, *Member, IEEE*, Eknath Vittal, *Student Member, IEEE*, Chris J. Dent, *Member, IEEE*, Gareth P. Harrison, *Member, IEEE*

Abstract—Distributed Generation (DG) is increasing in penetration on power systems across the world. In rural areas, voltage rise limits the permissible penetration levels of DG. Another increasingly important issue is the impact on transmission system voltages of DG reactive power demand. Here, a passive solution is proposed to reduce the impact on the transmission system voltages and overcome the distribution voltage rise barrier such that more DG can connect. The fixed power factors of the generators and the tap setting of the transmission transformer are determined by a linear programming formulation. The method is tested on a sample section of radial distribution network and on a model of the all island Irish transmission system illustrating that enhanced passive utilisation of voltage control resources can deliver many of the benefits of active management without any of the expense or perceived risk, while also satisfying the conflicting objectives of the transmission system operator.

Index Terms—Power distribution planning and operation, power transmission planning, linear programming, energy resources, wind power generation, losses.

I. INTRODUCTION

THE penetration of Distributed Generation (DG) is rapidly increasing on power systems across the world. Ambitious government targets for renewable generation and generally increasing oil and gas prices have served to maintain and indeed accelerate this demand for DG connections. These factors combined have presented a considerable challenge to distribution network operators (DNOs) and increasingly to transmission system operators (TSOs). In particular, DG poses well established technical challenges for the existing network infrastructure.

DNOs must now facilitate the connection of DG onto networks which were not designed for generation, whilst maintaining the DNO's primary role of delivering a secure and reliable supply of electricity to consumers. The main technical barrier to DG on distribution networks has been found to be voltage rise due to significant active power injections from DG [1]. It is mainly an issue on rural networks

due to their high impedance and low X/R ratio. A range of planning and operational methods have been proposed to alleviate the voltage rise barrier. In [2] and [3] methods for network capacity assessment and the optimal allocation of DG subject to the network constraints were proposed using AC optimal power flow (OPF) and linear programming models respectively. A number of active voltage control schemes have also been proposed utilising power factor control and tap changers in both a centralised and distributed manner [4]–[7]. The transition from a passive network to an active one has been widely mooted but, despite the range of voltage control methods developed, there has yet to be a migration to active network management. In [8], a novel approach to (decentralised) active management was proposed where rather than utilising DG to control the bus voltage, power factor control was designed to counteract the impact of that generator's active power output. This then allows the DNO to connect more DG, but in the traditional fit and forget manner.

The vast majority of work in this area has ignored the growing impact of DG on the transmission system. However, increasing penetrations of DG are presenting a challenge to TSOs as they plan and operate the transmission system. Conventional large scale generation which is dispatchable and used for voltage control is being displaced by DG which in many cases is non-dispatchable and does not have voltage control enabled. A consequence of this is increasing demand for reactive power at distribution network interfaces, below which DG is connected. This new additional reactive power demand is placing a strain on transmission system voltage resources and resulting in lower voltages at times of high DG output [9]. The issues of voltage rise on the distribution network and reactive power demands on the transmission system are conflicting. The selection of a fixed inductive power factor by the DNO serves to alleviate the distribution voltage rise issue, however the result is a large reactive power demand being made on the transmission system.

In this paper a method is proposed to determine the enhanced utilisation of voltage control resources for DG, such that the requirements and objectives of both the TSO and DNO are met. It is proposed here to determine an individual power factor setting for each generator that will facilitate more DG capacity than the current fixed power factors and reduce the negative impact on the transmission system. The settings of the on load tap changer of the transmission transformer are included as a variable in this formulation, as it will have an impact on the voltage levels on the network. **The optimisation method takes account of the capacity of the**

This work has been conducted in the Electricity Research Centre, University College Dublin which is supported by Airtricity, Bord Gáis, Bord na Móna, Commission for Energy Regulation, Cylon, EirGrid, Electricity Supply Board (ESB) Networks, ESB Power Generation, ESB International, Siemens, SWS, and Viridian. Andrew Keane and Eknath Vittal are funded through the Charles Parsons Energy Research Awards. This work is also part-funded through the EPSRC Supergen V, UK Energy Infrastructure (AMPerES) grant in collaboration with UK electricity network operators working under Ofgem's Innovation Funding Incentive scheme. A. Keane (andrew.keane@ucd.ie) and E. Vittal (eknath.vittal@ucd.ie), are with University College Dublin, Ireland. L. Ochoa, C. Dent and G. Harrison are with the Institute for Energy Systems, School of Engineering, University of Edinburgh, Edinburgh, EH9 3JL, U.K. (e-mail: luis.ochoa@ieee.org, chris.dent@ed.ac.uk, gareth.harrison@ed.ac.uk)

generation, its reactive power capability, the total DG reactive power, the normal and standby configuration of the network, and the sensitivity of the voltage at each network bus to reactive power injections at all buses. In so doing the method can achieve many of the benefits of proposed active management methods but through a passive method which will satisfy both the DNO and TSO in an easily implementable manner and ensure that the DNO's primary duty towards load customers is not compromised in any way. DG output can be highly variable. In particular, wind power is a highly variable energy resource and its variability is captured through a time series simulation for both the distribution and transmission system which serves to validate the determined enhanced settings.

Section II contains a description of the enhanced power factor method. The methodology is implemented and tested on a sample section of distribution network with a description of the network data and optimisation parameters in Section III. Results and discussion are given in Sections IV and V with conclusions given in Section VI.

II. METHODOLOGY

A. Objective Function

The calculation of the enhanced voltage control settings requires a range of factors to be included in the formulation of the objective function and constraints. The decision variables are Q_i , the generation reactive power and ΔV_{Tap} , the target voltage setting at the on load tap changer at the substation's transformer which minimises the reactive power from DG. The enhanced settings are determined using a linear programming (LP) formulation. The objective of the optimisation is to maximise the reactive power injections across all buses with a reactive power resource. This objective is chosen as it optimises the system from both the distribution and transmission perspectives, i.e. it will find a solution that satisfies the distribution voltage constraints (to satisfy the DNO), with the maximum possible reactive power injection (to satisfy the TSO).

1) *Transmission System Impact*: The maximisation of reactive power injections on the distribution network is chosen as the objective because it is equivalent to minimising reactive power import from the transmission system and will lead to the minimisation of the impact on the transmission system voltages. Increasing penetrations of DG on distribution networks are beginning to cause concerns for TSOs. In particular, the reactive power demanded by DG is presenting a drain on the transmission systems reactive power resources, leading to lower voltages on the system and increased risk of voltage instability [10]. As more DG is brought online in rural regions of the system; there is often a deficit of dynamic reactive generation and voltage performance suffers as a result. From a transmission system perspective, operating points where DG output is at its maximum and demand is low are of increasing concern. At these operating points DG is displacing large amounts of conventional generation which traditionally would have been utilised for voltage control. As a result, the minimisation of reactive power import from the transmission

system reduces the demand on the transmission system voltage control resources.

2) *DG Capacity*: On voltage constrained distribution networks, generators at voltage sensitive buses require inductive power factors, i.e. act as reactive power sinks. The maximisation of reactive power injections will determine the reactive power resources that satisfy the constraints with the least amount of reactive power demand. The permissible capacity of DG that may be connected without network upgrade or the implementation of an active control scheme will thus be increased, as will be shown later in Section IV.

The objective function (J (MVar)) is given as,

$$\text{Max} : J = \sum_{i=1}^N [LF]_i Q_i \quad (1)$$

where Q_i and $[LF]_i$ give the generation reactive power and load factor of the resource at the i th bus and N is the number of buses. The optimisation is calculated at the (maximum generation, minimum load) and (zero generation, maximum load) operating points. Maximum generation, minimum load is the worst case scenario for voltage rise on distribution networks, hence if the voltage rise constraint is obeyed at this point, it will be obeyed for all possible operating points. A low X/R ratio results in a greater coupling between active power and voltage, which makes voltage rise a particular problem on such networks. The load factors (LF) give the average output of each resource and are employed here to calculate the average reactive power of the reactive resources. They weight each resource according to its average output and thus those resources with higher average output will, where possible, be allocated higher reactive power output (less inductive).

The diversity of energy resources and the correlation of their outputs will hence have an impact when the temporal variation of output is considered. An important factor is that the reactive power capability of the generators decreases with active power output, according to the typical P-Q relationship for generators when operated at a fixed power factor. This has the effect that as the active power output (which is the cause of voltage rise) reduces, the reactive power which is used to counteract this effect also decreases. This formulation can also take account of any existing or proposed reactive power resources on the networks, allowing the calculation of their enhanced setting.

B. Reactive Power Capability

The reactive power limits of the generation are added to the formulation as a constraint, given by,

$$Q_{\min i} \leq Q_i \leq Q_{\max i} \quad \forall i \in N \quad (2)$$

where $Q_{\min i}$ and $Q_{\max i}$ are the minimum and maximum reactive power of the generator at the i th bus. Negative values for Q_i indicate inductive reactive power (Ind.) and positive values capacitive reactive power (Cap.). Typically, distribution codes require all generators connecting to the network to be able to operate between a given band of lagging and leading power factors [11]. In Ireland, the UK and other countries, DG has generally operated at a fixed power factor, with a value

of 0.95 (inductive) being a typical setting. Here, it is assumed that all generation on the network satisfies these requirements.

C. Voltage Level

The method is formulated assuming that there is existing DG installed on the network section. These generation capacities and load levels are employed to calculate the voltage level before the reactive power injection from the generators. Key parameters in the method's LP formulation of the voltage constraint are the reactive power bus voltage sensitivities and the transformer tap changer setting, a description of each is given now.

1) *Reactive Power Bus Voltage Sensitivities*: The sensitivity of the distribution bus voltages to reactive power (ρ_{ijk} , kV/MVAr) play a key role in determining at what level the power factors should be set. ρ_{ij} gives the voltage sensitivity of the j th bus to reactive power at the i th bus and V_{max} gives the maximum permissible voltage. They show how much the voltage changes per MVAr change in reactive power. Reactive power from a generator can significantly affect not only the bus to which that generator is connected but also to other nearby dependent buses.

The voltage sensitivities are dependent on the structure and impedance of the network. In radial distribution systems, feeders are separated by normally open points which define the normal feeder configuration. The N-1 feeder configurations are also included here. Indeed, the DNO may decide to move the normally open points for various operational reasons. The reactive power bus voltage sensitivities are therefore calculated for both the normal and N-1 feeder configurations. These N-1 configurations often present a reduced margin for voltage rise, hence it is important that they are considered.

The sensitivities are calculated through ac load flow analysis. The reactive power injection is added incrementally at each bus in turn and the voltage recorded.

2) *Transformer Tap Changer*: The transformer at the bulk supply point (BSP) is equipped with an on load tap changer, as is generally the case. The corresponding target voltage is commonly set to above nominal values to ensure that there are no low voltage conditions at the end of the feeders. In some cases there may be scope to lower this setting and increase the voltage margin for DG. The tap changer setting is included as a variable in the formulation. It is given by ΔV_{Tap} in pu and can vary according to the constraint given in,

$$-0.1 \leq \Delta V_{Tap} \leq 0 \quad (3)$$

where 0 p.u. indicates an unchanged tap setting from its default value at its upper limit, with a lower limit of -0.1 p.u. For the voltage constraint to be satisfied the voltage at each bus must be kept within its upper and lower limits. The critical operating points in each case are (maximum generation, minimum load) and (zero generation, maximum load) respectively.

3) *Upper Voltage Limit*: The upper voltage limit (in pu) is given as,

$$V_{BaseUp\ i} - \Delta V_{Tap} + \sum_{j=1}^N \mu_{ij} P_j + \sum_{j=1}^N \rho_{ij} Q_j \leq V_{max\ i} \quad \forall N \quad (4)$$

where μ_{ij} and P give the active power voltage sensitivity and the active power respectively. The active power voltage sensitivities are given in Table IX in the Appendix. It is the voltage rise from the generators that is of interest here. The base voltages ($V_{BaseUp\ ik}$) are therefore calculated under minimum load conditions.

4) *Lower Voltage Limit*: The lower voltage limit (in pu) is given as:

$$V_{BaseLow\ ik} + \Delta V_{Tap} \geq V_{min\ i} \quad \forall N, k \forall F \quad (5)$$

V_{min} is the lowest permissible voltage. The relevant operating point in this case is zero generation, maximum load conditions, being the worst case scenario for low voltage. $V_{BaseLow\ ik}$ is calculated for each bus for the maximum load, zero generation scenario. This scenario represents the maximum voltage drop that will be experienced on the network. Both of these constraints must be satisfied under N and N-1 conditions. To achieve this the active power and reactive power sensitivities and the upper and lower base voltages ($V_{BaseUp\ ik}$, $V_{BaseLow\ ik}$) are calculated for a set of F possible N and N-1 feeder configurations. This leads to multiple instances of (4) and (5).

III. TEST SYSTEMS AND OPTIMISATION PARAMETERS

The methodology is applied to a sample radial section of the Irish 38 kV distribution network, the impact on the transmission system is determined by modelling the all island Irish transmission system. These models are separate due to the computation requirements of a combined model. The optimisation method is solved using the XA 15 linear programming solver.

The distribution network section analysed is a typical rural section of the Irish 38 kV distribution network, shown in Fig. 1. **The normally open points, labelled N.O. are closed under N-1 feeder conditions. Such conditions arise on this network when, for example, the line Tx-A is switched out.** The line impedances and load data for the network are given in Table VIII in the Appendix. It is assumed that each generator is connected to the network via a 5 km overhead line. The rating of the substation 110/38 kV transformer is 31.5 MVA and the maximum load experienced on the system is 15.5 MW. The initial target voltage at the secondary of the substation transformer is 41 kV (1.08 pu). The statutory voltage limits are $\pm 10\%$.

The assumed installed DG capacity is shown in Table II. A DG scenario is assumed with a total of 32 MW connected on the network across six of the buses (including the transmission bus) with no generation connected at one of the buses. PF_{min} is assumed to be 0.90 (inductive/capacitive) for all generators. A biomass generator is assumed to be installed at bus B with wind farms connected at the other locations, in order to test the methodology with a diversity of energy resources. It is also assumed that there are no capacitor banks currently connected. A relevant factor is the type of electrical machine employed for each energy resource. Wind farms employ doubly fed induction generators, squirrel cage induction generators (with power factor correction capacitors) or full converter synchronous

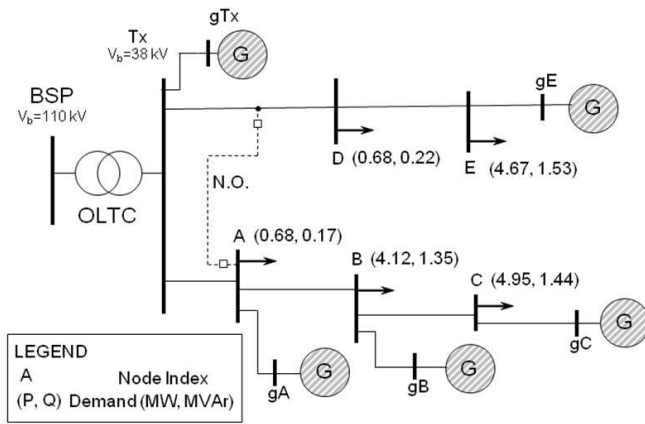

Fig. 1. 38 kV 5 bus radial distribution network diagram (max. load level)

machines. Each of these machine types will be able to operate continuously at any fixed power factor within the defined range in the distribution code. Other resources such as biomass may employ a conventional synchronous machine. Such machines, if operated at a large inductive power factor, may have a large rotor angle, leading to stability concerns for the DNO. Such factors could be included as an additional constraint on the permissible power factors for DG if required.

The base voltage at the buses, relevant to the upper and lower voltage limit are shown in Table I.

TABLE I
BASE VOLTAGES (PU)

Bus	A	B	C	D	E	Tx
V_{BaseUp}	1.0718	1.0526	1.0487	1.0508	1.0474	1.0789
$V_{BaseLow}$	1.0508	0.9561	0.9237	1.0097	1.0039	1.0789

TABLE II
DG CAPACITY (MW) AND LOAD FACTORS FOR SCENARIOS 1 AND 2

Scenario 1						
Bus	A	B	C	D	E	Tx
DG Capacity	6	5	7	0	8	6
LF	0.35	0.85	0.35	-	0.30	0.30
Scenario 2						
Bus	A	B	C	D	E	Tx
DG Capacity	4	6	5	5	7	5
LF	0.35	0.85	0.35	0.30	0.30	0.30

A. Reactive Power Bus Voltage Sensitivities

The sensitivity of the distribution bus voltages to reactive power injections plays a key role in determining at what level the power factors should be set. They are calculated by fixing all network parameters including the load and generation and solely incrementing the reactive power of each DG plant in turn. The voltages at each bus are recorded at each step in this process resulting in the

sensitivities shown in Table III. The sensitivities shown are for the normal feeder configuration. The diagonal elements are the individual bus voltage sensitivities and the off diagonal elements give the interdependence between buses. The N-1 sensitivities are also calculated and employed in the optimisation to ensure that no constraint breaches occur under contingency conditions. The OLTC at the BSP is set to regulate the secondary side of the transformer to a fixed value, hence the zero values for voltage sensitivity at the Tx bus. The primary side voltage will vary dependent on the power flow through the transformer. The primary side is essentially the slack bus and its voltage cannot be adequately determined without a proper representation of the 110 kV transmission system. It was found that the sensitivities generally increased under N-1 conditions, but also that the sensitivity to active power injections proportionately increased, with the result that the N-1 condition did not present a more severe constraint as may have been expected.

TABLE III
REACTIVE POWER VOLTAGE SENSITIVITY FOR NORMAL FEEDER CONFIGURATION (kV/MVAR)

ρ	A	B	C	D	E	Tx
A	0.0274	0.0272	0.0272	0	0	0
B	0.0275	0.2292	0.2287	0	0	0
C	0.0277	0.2313	0.3663	0	0	0
D	0	0	0	0.3898	0.3895	0
E	0	0	0	0.3917	0.4456	0
Tx	0	0	0	0	0	0

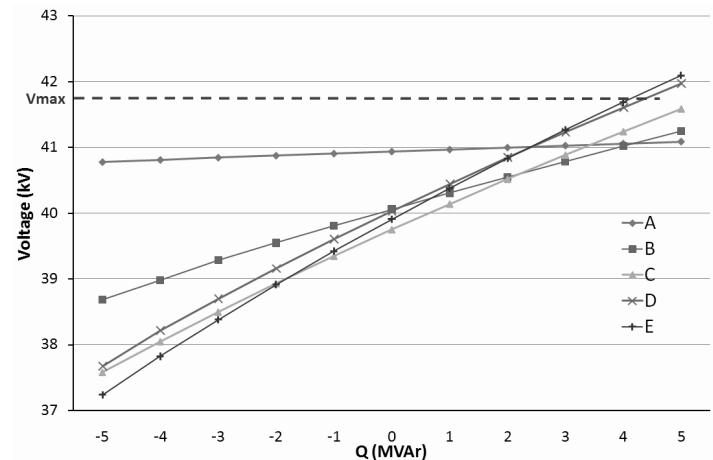

Fig. 2. Individual bus voltage sensitivities to reactive power injections at the same bus (kV/MVar)

Fig. 2 shows the voltage sensitivity characteristics of each bus to reactive power injections at that bus. The maximum permissible voltage is indicated in the figure by the horizontal dashed line. It can be seen that the sensitivity of the buses increases with distance (impedance) from the fixed voltage transmission bus, with buses C and E the most voltage constrained.

Fig. 3 shows the voltage sensitivity of all buses to reactive power injections at bus C. This figure shows the level of

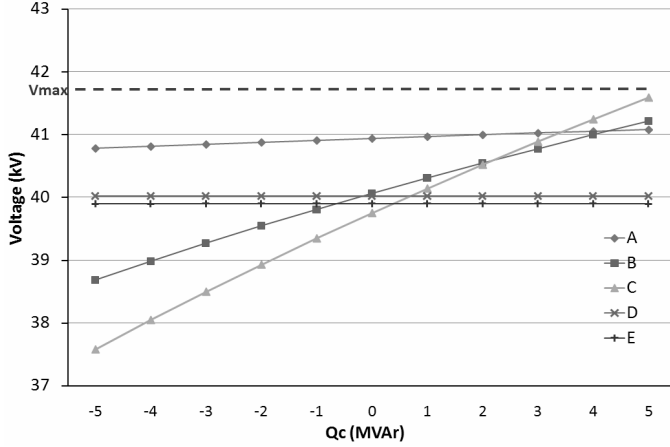

Fig. 3. Voltage sensitivity of all buses to reactive power injections at Bus C (kV/MVAr)

interdependency between reactive power at bus C and all other buses for the normal feeder configuration. It can be seen that the bus which exhibits the highest sensitivity other than C itself is bus B which is closest to it.

IV. RESULTS

The enhanced fixed power factors calculated using the above method are shown in Table IV for scenarios 1 and 2. It can be seen that capacitive power factors were allocated to DG connected at buses with a lower reactive power bus voltage sensitivity, such as buses Tx (0.90 Cap.) and A (0.90 Cap.) in scenario 1. Buses located further out in the networks and hence with a higher bus voltage sensitivity were allocated inductive power factors, such as buses B (0.93 Ind.) and C (0.90 Ind.). The overall generation power factor seen by the transmission system is 0.998 inductive when all generators are at their maximum. In order to assess the robustness of the method, the 6 MW generator at bus Tx is taken to be out of service. In such a case the overall generation power factor reduces to 0.986 inductive, with all constraints still respected. The enhanced ΔV_{Tap} (also shown in Table IV) indicates that the tap changer should have a target voltage of 40.7 kV (1.072 pu).

TABLE IV
ENHANCED POWER FACTORS (PFS) & TAP SETTING

Bus	Scenario 1	Scenario 2
	Power Factor	Power Factor
A	0.90 (Cap.)	0.90 (Cap.)
B	0.93 (Ind.)	0.90 (Ind.)
C	0.90 (Ind.)	0.96 (Ind.)
D	-	0.90 (Ind.)
E	0.94 (Ind.)	0.93 (Ind.)
Tx	0.90 (Cap.)	0.90 (Cap.)
Overall DG PF	0.998 (Ind.)	0.987 (Ind.)
ΔV_{Tap}	-0.008 pu	-0.008 pu

Scenario 2 introduces a variation in the DG capacities, locations and load factors. It shows similar behaviour with

slightly more inductive overall DG power factor due to the reduction of available reactive power at bus Tx and A. DG output and the load will vary according to the time of day and season. It is important therefore to assess the temporal performance of these power factors over a year. Two separate time series ac power flow simulations are required for this purpose, a transmission analysis and a distribution analysis. **The modelling and computation requirements of a joint transmission system and distribution system are extremely high. For this reason they are kept separate. Despite this, the method takes account of both systems' requirements in a single optimisation method. Furthermore, it is important to also bear in mind that due to legal unbundling, it is not realistic to propose the optimised operation of the transmission and distribution networks simultaneously.** Details of the transmission and distribution time series power flow analyses and their associated results are given below in Sections IV-B and IV-A respectively. Only scenario 1 is included in the time series analysis.

A. Distribution System Analysis

For the distribution system analysis, an annual time series power flow simulation was performed consisting of half hourly ac power flow calculations for the distribution network shown in Fig. 1. Data for historical time series for the distribution load was obtained from Electricity Supply Board (ESB) Networks, the Irish DNO. A wind power output time series for each bus was not available so the distribution network section was split into two areas, with buses A, B and C utilising one time series and buses D, E and Tx utilising the second time series. A separate historical biomass power output time series was used for the generator at bus B. The two wind time series used were historical wind farm time series with identical time stamps. The wind farms used as the source for each time series are located approximately 35 km apart. This is important for the distribution analysis as it is the correlation between closely located wind farms that needs to be captured.

The distribution time series power flow analysis allows a quantification of the reactive power import from the transmission system and distribution losses. A number of scenarios were assessed, with fixed power factors of 0.95 inductive and unity power factor simulated along with the enhanced fixed power factor settings. Results for each of these are now given.

1) *Reactive Power Demand:* The impact of wind generation on the transmission system is monitored throughout the year in terms of the reactive power seen at the bulk supply point (Q_{Imported}). The statistical properties of Q_{Imported} for the year are shown in Table V.

It can be seen that under the fixed power factor scenario, the reactive power import from the transmission system is substantially increased. The standard deviation highlights that the introduction of wind power results in increased variability in reactive power. Under the enhanced fixed power factor scenario the transmission system sees an average reactive power demand of 4.56 MVAr. This represents an increase over the zero generation case, but is considerably less than value of 7.54 MVAr for 0.95 power factor. In this case the enhanced

TABLE V
BULK SUPPLY POINT REACTIVE POWER (MVAR)

Q_{Imported}	Zero Gen.	0.95 (Ind.)	Enhanced PF
Max.	4.56	15.88	7.48
Min.	1.01	1.02	1.02
Mean	2.52	7.54	4.56
Std. Dev. (σ)	0.71	3.90	1.11
Total (MVarh)	22,110	66,069	39,919

fixed power factor settings result in an overall DG power factor that is very close to unity. This is beneficial to the TSO, but also facilitates extra generation capacity at no extra cost, which is beneficial to the DNO and DG developers. The voltage at each bus was also monitored throughout the year and, as expected, the enhanced fixed power factor scenario resulted in no voltage violations. **The unity power factor scenario is not included here as it results in severe overvoltages for the listed DG capacity and hence is not a realistic scenario. The zero generation case does indicate the level of reactive power import that would occur with unity power factors. It should be noted that there will be differences arising from the voltage dependency of the load.**

2) *DG Capacity*: One of the benefits of the enhanced fixed power factor settings is that they will facilitate greater levels of generation to connect than the typical 0.95 inductive or unity power factors that are generally selected by the DNO. The voltage levels resulting from the enhanced fixed power factors are now compared to the more typical scenario of 0.95 inductive and unity power factor. Firstly, the voltage levels for both scenarios are compared for the worst case of maximum generation, minimum load. The maximum allowable voltage on the Irish 38 kV network is 41.7 kV (1.1 pu). It was found that the 0.95 inductive power factors resulted in overvoltages of 41.74 kV, 41.77 kV and 41.92 kV at buses C, D and E respectively. In order to quantify the capacity benefit of the enhanced power factors a simplified version of the method in [12] was employed. It was found that the maximum generation capacity that can connect at these buses with 0.95 fixed power factors is 29.3 MW. The enhanced fixed power factors have therefore facilitated an increase of 9% (2.7 MW) in DG capacity at no extra cost, when compared to the (assumed 32 MW) traditional fixed 0.95 power factor scenario. Under the same conditions for unity power factors the total amount of generation that can connect is 22.4 MW which is a reduction of 9.6 MW. These results are summarised in Table VI.

TABLE VI
TOTAL DG CAPACITY FOR VARIOUS POWER FACTOR SETTINGS (MW)

Enhanced PF	0.95 (Ind.)	Unity PF
32.0	29.3	22.4

This snapshot analysis confirms that the assumed 32 MW of generation can now connect with the enhanced fixed power factors, as it satisfies the voltage constraint under normal and N-1 feeder conditions. It is interesting to note that the BSP

transformer capacity plus minimum load places a limit on the potential DG capacity, in this case 37.05 MW. This indicates that an extra 5.05 MW could be facilitated by active voltage management over the initial assumed DG penetration of 32 MW, which is only feasible with enhanced passive means.

3) *Distribution Losses*: Losses are an important consideration in any aspect of power system planning. Much work has been devoted to assessing and minimising losses on distribution systems [13], [14]. The losses resulting from enhanced fixed power factor operation and traditional fixed power factor operation are compared in Table VII. The losses with no generation connected are also given.

TABLE VII
ANNUAL LOSSES (MWh) AND LOSSES AS A PERCENTAGE OF UNITS DELIVERED (%)

Losses	MWh	%
Zero Gen.	3,527	3.97
0.95 (Ind.)	2,775	3.12
Enhanced PF	3,174	3.57

It can be seen that the losses are affected by the power factors of the generation. In both cases the losses are reduced considerably by the introduction of generation onto the network. This may not always be the case and is dependent on the size and location of the generation. In this case there are multiple generators at various sites, so a reduction in losses can be expected. In cases where there are a smaller number of larger generators at remote buses, an increase in losses may occur.

It can also be seen that the enhanced fixed power factors result in an increase in losses over the fixed 0.95 power factors. This is due to the lower power factors at buses C and B of 0.90 and 0.93 respectively. The increased reactive power demand causes increased current along the lines to these buses over the year resulting in slightly higher losses. Nonetheless, these increased losses are significantly lower than the losses incurred when no generation is present. The total annual output from the DG over the year is 125.99 GWh. The annual units delivered (demand) for this network amount to 85.89 GWh. Table VII also shows the units lost (losses) as a percentage of the units delivered. **The reduction of losses is a priority for DNOs and it has been demonstrated that, for the adopted case study, the connection of DG results in reduced losses in all scenarios. Another important priority for DNOs is the connection of DG, in particular renewable DG. A balance is achieved here between increased DG penetration and reduced losses, albeit not minimum losses.**

B. Transmission System Analysis

In the Republic of Ireland, the transmission system voltage levels are 110 kV, 220 kV and 400 kV. It is the interface between the distribution and transmission systems at the 110 kV level that is of interest here. The distribution network section under study here is located in the south west of the country in a rural area with low load and limited reactive power resources. The transmission system model employed

here is based on the planned system for 2013 [15]. 2013 is chosen as the expected high penetrations of wind and DG will exhibit more impact upon the system. For voltage stability studies, the worst-case operating point occurs when DG serves the largest proportion of the system's demand. From analysis of 2013 time series, (scaled from 2006 historic load and wind data) for system demand and planned penetrations of wind and DG in 2013, this point was found to be on October 31st. A 30 minute time series ac power flow analysis of the all island Irish transmission system was carried out for a two week period around this worst case operating point for voltage stability [9].

DG output is highly variable, therefore it is updated between every time step in the power flow analysis. This variability requires a unit commitment and an economic dispatch to be carried out for the conventional generators on the system. A unit commitment schedule for the two weeks in October was used to account for which units would be on during a particular day [16]. Economic dispatch is employed to account for the generation load balance between the 30 minute time-steps. Heat rate curves for each of the conventional units in the system were written into the economic dispatch application, and based on the unit commitment schedule, this provided the load/generation balance at each time-step [17].

New wind generators are connected based on the resource analysis from the All-Island Grid Study [17]. The transmission system is divided into wind regions, and the region's time series used for all farms in the region. Wind power time series were fed into each individual wind generator based on its wind region. They all connect at or below the designated 110 kV bus. Distribution connected generation is modelled behind an impedance below the 110 kV transformer as a means of modelling a general distribution network. The specific distribution section under study here was modelled in detail separately. For the transmission analysis the DG time series (wind and biomass), capacities and power factors were combined into a single aggregate time series for active and reactive power. This aggregate generator was connected through its corresponding 110/38 kV transformer to the transmission system. The overall result is a realistic picture of the connected wind generation on the all island Irish power system in terms of both capacity and location.

1) Transmission Voltage Stability: Power Voltage (PV) curves are displayed for the results of the two week time-series power flow analysis. The data used in the time-series power flow was correlated wind power output and loading data for 15 minute intervals specific to the region in which the farm was located [9]. The 15 minute wind power output data was deemed sufficient in order to assess the voltage stability of the system for a time-series power flow simulation based on the definition of long-term, small-disturbance voltage stability [18]. **In [18], this type of voltage stability encompasses the small-disturbances in the system, such as changes in load or generation over the slower acting equipment in the system, such as tap-changing transformers, thermostatically controlled loads, and generator current limiters.**

The effect of the optimal power factors is demonstrated in the PV curves of the 110 kV bus connected to the 38

kV bus through a transformer. The behavior of PV curves and the relationship to voltage stability is a well established concept [19], [20]. The PV curve is influenced by the PF of the system. More inductive PFs limit the power transfer capability of the bus, and lower the value at which the critical voltage is reached. The opposite is true for capacitive PFs, where the critical voltage or the point of voltage collapse is extended and allows for increased power transfer in the system. **This extension of the critical voltage point is known as the voltage stability margin, and is a measure that directly reflects an increase in voltage stability in the power system and indicates that the system is more secure. Since the maximum power transfer for a particular bus is limited to the size of the connected wind farm, the voltage value reached at maximum power will indicate an increase or decrease in the voltage stability margin of a bus.**

Fig. 4 shows the resulting PV curve noses for the 110 kV BSP bus with fixed 0.95 power factors, while Fig. 5 shows the same for 110 kV BSP bus with enhanced fixed power factors. The impact of the enhanced fixed power factors is evident in Fig. 5, as the power generated by the DG increases, voltages actually increase at the 110 kV bus. The system is thus more secure and is better able to cope with an unexpected contingency. The voltages in Fig. 4 are still within the range of stability, but are seen to be noticeably falling as power production increases from the wind farm leading to a decrease in system security. System security is defined as the ability of the power system to withstand a sudden loss or unanticipated loss of system components [18]. This effect is particularly evident from comparison of the noses of the two curves. **With traditional fixed power factors, in Fig. 4 there is a decline in voltage at the upper levels of DG output. This effect has been flattened out in Fig. 5 due to the enhanced power factors.**

Based on [19], this implies that the voltage stability margin for that particular bus is extended and the security of the system is improved when the use of optimal power factors is implemented. Not only does the implementation of optimal power factors improve the PV curve's voltage stability margin, it also controls the range of voltage at the 110 kV bus between a smaller bandwidth and increases system security as seen in Fig. 5. This demonstrates the value of increased terminal voltage control and allows for more predictable voltages at the transmission level leading to more robust system operation.

V. DISCUSSION

The method presented here is a purely passive approach. It highlights that some of the benefit of active management can be achieved through intelligent selection of settings. One of its major advantages is that it does not require any additional network investment or communications infrastructure. Indeed, it is a readily implementable solution. It avoids the many commercial and regulatory barriers which have stymied active management to date. In addition, it is a low risk solution which should appeal to DNOs, whose primary responsibility is to ensure a reliable, high quality supply to its customers. The method takes

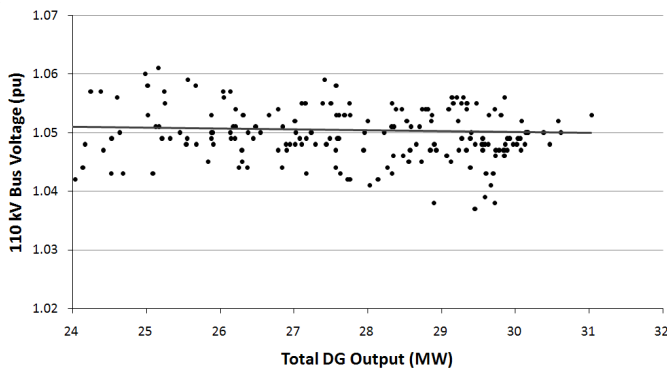

Fig. 4. Nose of PV Curve for 110 kV BSP bus with fixed 0.95 power factors

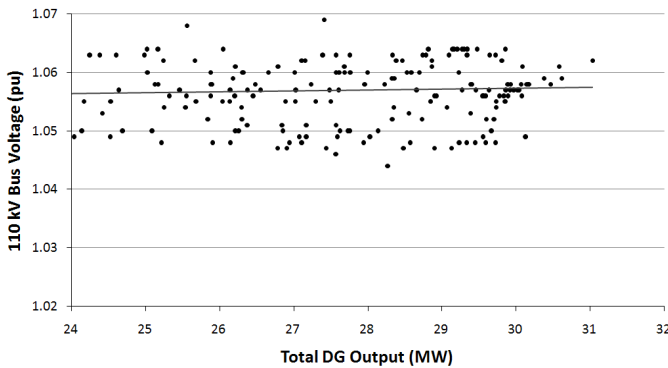

Fig. 5. Nose of PV Curve for 110 kV BSP bus with enhanced fixed power factors

account of the N-1 configurations and the only events which would require recalculation of the power factors would be extended disconnection of one of the generators or the connection of a new generator or load growth from year to year. The calculation for such events is easily implementable.

The method is intended for analysis of large penetrations of DG. If there is not a significant penetration of DG, the method will still solve but will reduce to selecting the maximum power factor of the one or two DG units that satisfies the distribution voltage constraint. Regarding system size, the test system presented is relatively small and a larger system would likely have a greater diversity across the buses and provide greater margin for the enhancement of the power factors. The method provides a baseline against which active control methods could be measured and indicates the level of further benefits that active management should deliver if it is to achieve widespread adoption. It could also be employed to model a more active scheme, whereby constraint limits could be extended to take account of more active management of resources. For example if the tap changer settings were set on a seasonal or monthly basis, this would provide scope for extending the constraint limits of (5). In Spain, for example, a power factor scheme is implemented whereby DG has three different power factor settings dependent on the system load level [21]. The method proposed here could be employed in such a situation to

calculate the enhanced fixed power factors for various load and generation levels. Here the settings are calculated based on two extreme operating points, (maximum generation, minimum load and zero generation, maximum load), and illustrates that even in such a case, the method can deliver significant benefits to both the DNO and TSO, as validated by the time series analyses. The methodology takes account of the N-1 line contingencies. Generator outages can also occur and the method could be extended to take account of each possible DG contingency. In addition, if new DG is connected or existing units decommissioned, the enhanced settings could be recalculated and reset appropriately.

Distribution codes specify the required capabilities of DG plants. Typically, they are required to operate between a range of power factors. The network operators will instruct the DG owner to operate at a given power factor in this range. In networks where voltage rise is the main barrier, inductive power factors of 0.95 would be typical, as in the Irish case. Where voltage rise is not an issue, unity power factor could be employed. The reactive power capability of DG is a significant resource and, as has been demonstrated here can be used in a passive manner for the benefit of the system. This passive implementation avoids any of the potential difficulties regarding active coordinated control between multiple generators and as a result is readily implementable without any major technical barriers. The impact on the transmission system of large penetrations of DG is becoming increasingly important. The migration of large amounts of voltage control resources to the distribution system indicates that the utilisation of these resources is no longer an issue for just the DNO but also for the whole power system. This method utilises the reactive support resources for the benefit of the distribution system and transmission systems. **The method has been well received by EirGrid the Irish TSO and ESB Networks, the Irish DNO. ESB Networks see potential benefits in it and have adopted it as part of their smart networks plan. It is planned to run a trial of the method on a section of the Irish distribution network where there is a cluster of DG units, thus providing a good test of the method's robustness.**

VI. CONCLUSIONS

In this paper an optimisation approach has been developed for the utilisation of voltage control resources with DG from both the transmission and distribution perspective. The method optimises the power factor and tap changer settings of the distribution network section such that distribution voltage limits are obeyed at all times and the transmission system impact of DG is reduced. It has been shown that the margin of DG reactive power capability and the bandwidth of the on load tap changer can be used, in a passive manner, to satisfy the conflicting objectives of the TSO and DNO. The connection of DG has resulted in the migration of significant voltage control resources to the distribution network. The reactive power capabilities of generation on the transmission system have long been an important resource for TSOs. It has been shown here that the same capabilities of DG along with existing

distribution control measures are gaining more importance for both distribution and transmission system operation.

ACKNOWLEDGMENTS

The authors gratefully acknowledge ESB Networks and EirGrid for their help with this work.

APPENDIX

TABLE VIII

TEST SYSTEM IMPEDANCE AND MINIMUM LOAD DATA

Line	Lines		Bus	Load	
	R (Ω)	X (Ω)		P (MW)	PF
Tx-A	1.19	1.176	A	0.25	0.97 (Ind.)
Tx-D	3.36	3.53	B	1.5	0.95 (Ind.)
A-B	2.98	3.14	C	1.8	0.96 (Ind.)
B-C	9.32	9.80	D	0.25	0.95 (Ind.)
D-E	10.44	10.98	E	1.74	0.95 (Ind.)

TABLE IX

ACTIVE POWER VOLTAGE SENSITIVITY FOR NORMAL FEEDER CONFIGURATION (kV/MW)

μ	A	B	C	D	E	Tx
A	0.0098	0.0098	0.00976	0	0	0
B	0.00852	0.2021	0.2016	0	0	0
C	0.00752	0.1909	0.3148	0	0	0
D	0	0	0	0.3438	0.3433	0
E	0	0	0	0.3363	0.3850	0
Tx	0	0	0	0	0	0

REFERENCES

- [1] C. Masters, "Voltage rise the big issue when connecting embedded generation to long overhead 11kV lines," *IEE Power Engineering Journal*, pp. 5–12, Feb. 2002.
- [2] G. Harrison and A. Wallace, "Optimal power flow evaluation of distribution network capacity for the connection of distributed generation," *IEE Proc.-Gener. Transm. Distrib.*, vol. 152, no. 1, pp. 115–122, Jan. 2005.
- [3] A. Keane and M. O'Malley, "Optimal utilisation of distribution networks for energy harvesting," *IEEE Trans. Power Syst.*, vol. 22, no. 1, pp. 467–475, 2007.
- [4] C. Hird, H. Leite, N. Jenkins, and H. Li, "Network voltage controller for distributed generation," *IEE Proc.-Gener. Transm. Distrib.*, vol. 151, no. 2, pp. 150–156, Mar. 2004.
- [5] S. Liew and G. Strbac, "Maximising penetration of wind generation on existing distribution networks," in *IEE Proc.-Gener. Transm. Distrib.*, vol. 149, May 2003, pp. 256–262.
- [6] P. Vovos, A. Kiprakis, A. Wallace, and G. Harrison, "Centralized and distributed voltage control: Impact on distributed generation penetration," *IEEE Trans. Power Syst.*, vol. 22, no. 1, pp. 476–483, Feb. 2007.
- [7] L. F. Ochoa, C. J. Dent, and G. P. Harrison, "Maximisation of intermittent distributed generation in active networks," in *CIREC Seminar 2008: SmartGrids for Distribution*, Frankfurt, June 2008.
- [8] P. Carvalho, P. F. Correia, and L. Ferreira, "Distributed reactive power generation control for voltage rise mitigation in distribution networks," *IEEE Trans. Power Syst.*, vol. 23, no. 2, pp. 766–772, May 2008.
- [9] E. Vittal, M. O'Malley, and A. Keane, "A steady-state voltage stability analysis of power systems with high levels of wind," *IEEE Trans. Power Syst.* (in press), 2009.

- [10] E. Vittal, A. Keane, and M. O'Malley, "Varying penetration ratios of wind turbine technologies for voltage and frequency stability," in *IEEE PES General Meeting*, Pittsburgh, July 2008.
- [11] *Irish Distribution Code*, ESB Networks Std. v2.0, 2007. [Online]. Available: <http://www.esb.ie/esbnetworks/>
- [12] A. Keane and M. O'Malley, "Optimal allocation of embedded generation on distribution networks," *IEEE Trans. Power Syst.*, vol. 20, no. 3, pp. 1640–1646, Aug. 2005.
- [13] V. H. Mendez, J. R. Abbad, and T. Roman, "Assessment of energy distribution losses for increasing penetration of distributed generation," *IEEE Trans. Power Syst.*, vol. 21, no. 2, pp. 533–540, May 2006.
- [14] T. Griffin, K. Tomsovic, D. Secrest, and A. Law, "Placement of dispersed generations systems for reduced losses," in *Proceedings of the 33rd International Conference on System Sciences*, Hawaii, Jan. 2000.
- [15] EirGrid. (2009) EirGrid Forecast statement 2008-2014. [Online]. Available: <http://www.eirgrid.com/>
- [16] A. Tuohy, P. Meibom, E. Denny, and M. O'Malley, "Unit commitment for systems with significant wind penetration," *IEEE Trans. Power Syst.*, vol. 24, no. 2, May 2009.
- [17] All Island Renewable Grid Study - Workstream 2B, "Wind variability management studies," Tech. Rep., 2008. [Online]. Available: <http://www.dcenr.gov.ie>
- [18] P. Kundur, J. Paserba, V. Ajjarapu, G. Andersson, A. Bose, C. Canizares, N. Hatziargyriou, D. Hill, A. Stankovic, C. Taylor, T. V. Cutsem, and V. Vittal, "Definition and classification of power system stability," *IEEE Trans. Power Syst.*, vol. 19, no. 2, 2004.
- [19] P. Kundur, *Power System Stability and Control*. McGraw-Hill, London, 1994.
- [20] C. Taylor, *Power System Voltage Stability*. McGraw-Hill, Texas, 1993.
- [21] REE. (2009) Spanish grid code. [Online]. Available: <http://www.ree.es/ingles/home.asp>

Andrew Keane (S'04, M'07) received a B.E. degree in electrical engineering and a PhD from University College Dublin in 2003 and 2007 respectively. He is a lecturer with the School of Electrical, Electronic and Mechanical Engineering at University College Dublin with research interests in power systems planning and operation, distributed energy resources and distribution networks.

Luis F. Ochoa (S'01-M'07) is a Research Fellow in the School of Engineering, University of Edinburgh, U.K. He obtained his BEng degree from UNI, Lima, Peru, in 2000, and the MSc and PhD degrees from UNESP, Ilha Solteira, Brazil, in 2003 and 2006, respectively. His current research interests include network integration of distributed energy resources and distribution system analysis. He is also a member of the IET and CIGRE.

Eknath Vittal (S'07) Eknath Vittal received his B.S. degree from the University of Illinois Urbana-Champaign and his M.S. from Iowa State University in Electrical Engineering in 2005 and 2007 respectively. He is currently studying for his Ph.D. at University College Dublin with research interests in power system operation and planning.

Chris J. Dent (M'08) is a Research Fellow in the School of Engineering at the University of Edinburgh, U.K. He obtained his BA degree in Mathematics from Cambridge University in 1997, PhD in Theoretical Physics from Loughborough University in 2001, and MSc in Operational Research from the University of Edinburgh in 2006. His current research interests lie in OPF algorithms, network generation capacity assessment, and network risk assessment.

Gareth P. Harrison (M'02) is a Senior Lecturer in Energy Systems in the School of Engineering, University of Edinburgh, U.K.. His current research interests include network integration of distributed generation and analysis of the impact of climate change on the electricity industry. Dr. Harrison is a Chartered Engineer and member of the IET.